



GUHRING

MILLING TOOLS

NEW LEVEL



OPTIMAL
CO-ORDINATION
OF ALL TOOL
PARAMETERS ...

TOOL MATERIALS
Own carbide production

MACHINE & EQUIPMENT DIVISION
Own machine tool and equipment divisions



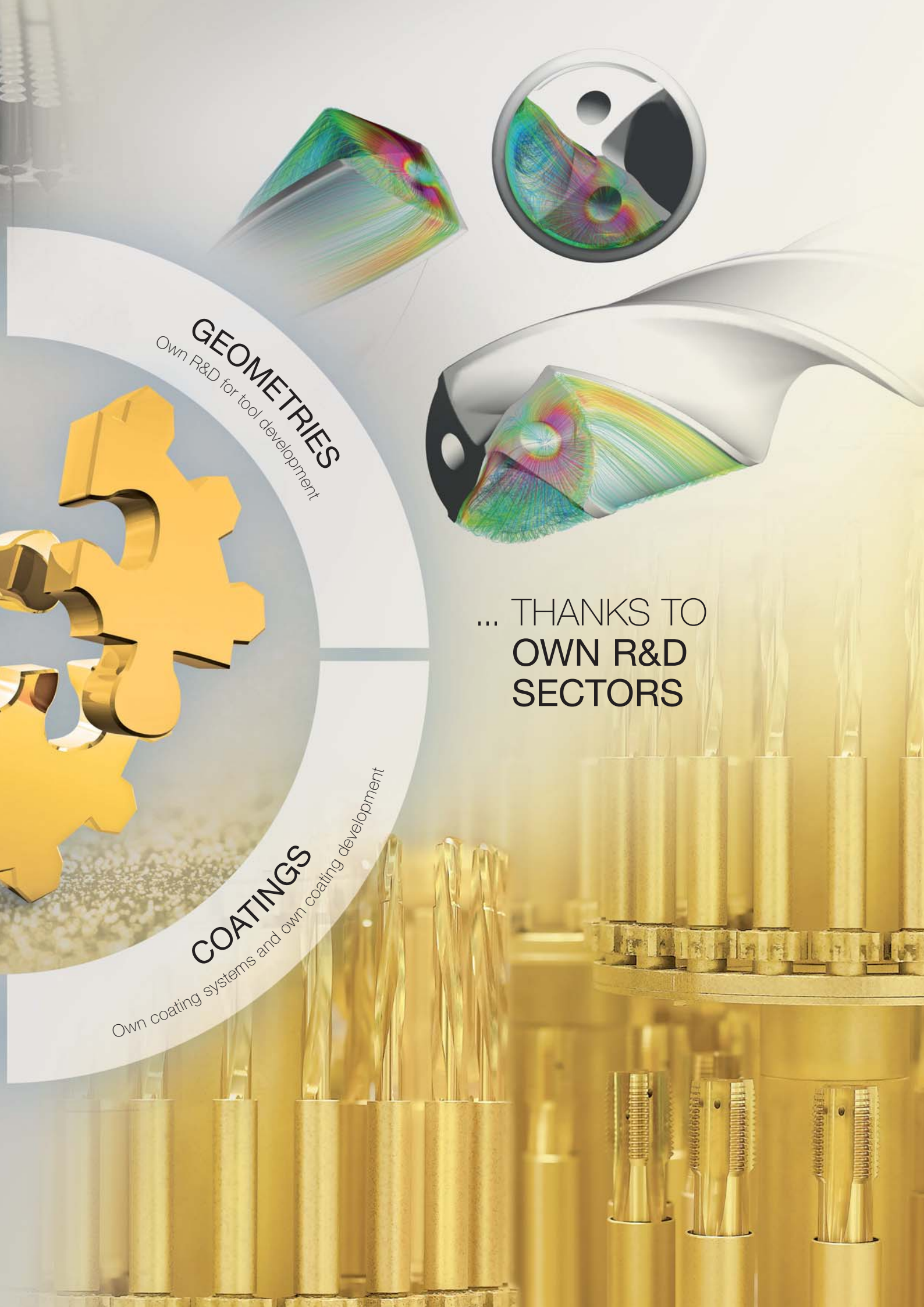

GEOMETRIES
Own R&D for tool development

COATINGS
Own coating systems and own coating development

... THANKS TO
**OWN R&D
SECTORS**

EVERYTHING FROM ONE SUPPLIER

– COMPREHENSIVE AND GLOBAL



AMERICA

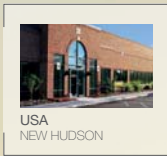
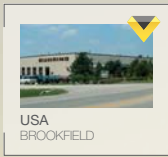
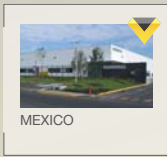
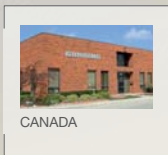
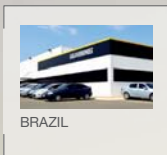

ASIA

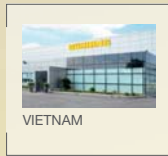
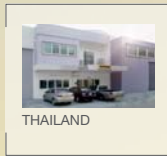
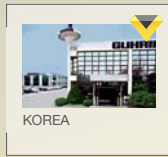
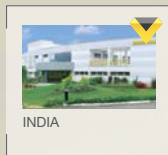
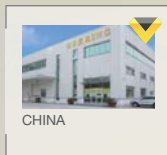

AFRICA

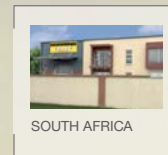



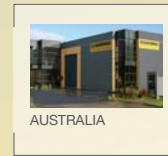



































AUSTRALIA



48 SUBSIDIARIES

MORE THAN 70 PRODUCTION AND SERVICE CENTRES



 GREAT BRITAIN	 SPAIN	 FRANCE				
 NETHERLANDS	 BELGIUM	 SWEDEN				
 DENMARK	 SWITZERLAND ROTKREUZ	 SWITZERLAND ALTDORF				
 GERMANY ALBSTADT-HEADQUARTER	 GERMANY ALBSTADT-FACTORY II	 GERMANY ALBSTADT-FACTORY III				
 GERMANY SIGMARINGEN-LAIZ	 GERMANY BERLIN	 GERMANY TREUEN-FACTORY I				
 GERMANY TREUEN-FACTORY II	 GERMANY TREUEN-FACTORY III	 GERMANY CHEMNITZ				
 GERMANY EISENACH	 GERMANY MARKT ERLBACH	 GERMANY GEISLINGEN	 GERMANY WEHINGEN	 GERMANY MINDELHEIM	 GERMANY LEVERKUSEN	 GERMANY LANGEN-HAGEN
 GERMANY RAMSTEIN	 GERMANY NEUTRAUBLING	 GERMANY KULMBACH	 GERMANY NUREMBERG	 GERMANY ZORBAU	 ITALY MISSAGLIA	 ITALY UBIEMME
 AUSTRIA	 POLAND	 RUMANIA	 RUSSIA	 CZECH REPUBLIC	 TURKEY	 HUNGARY

EUROPE



Page 11
CAST IRON

Cast iron types such as grey cast iron (GG25), spheroidal graphite iron, malleable cast iron and cast steel alloys, abrasive special cast alloys



Page 11
STEEL

General steel grades from low to high tensile strength (500-1400 N/mm²); high-tensile heat-treatable and tool steels (- 48 HRC); hardened steels and chilled cast iron also above 63 HRC





Page 71

STAINLESS STEEL

Stainless steels, acid- and heat-resistant alloys; titanium and nickel alloys; difficult-to-machine special alloys



Page 113

ALUMINIUM

Aluminium wrought alloys; high-tensile aluminium; silicon-containing cast aluminium

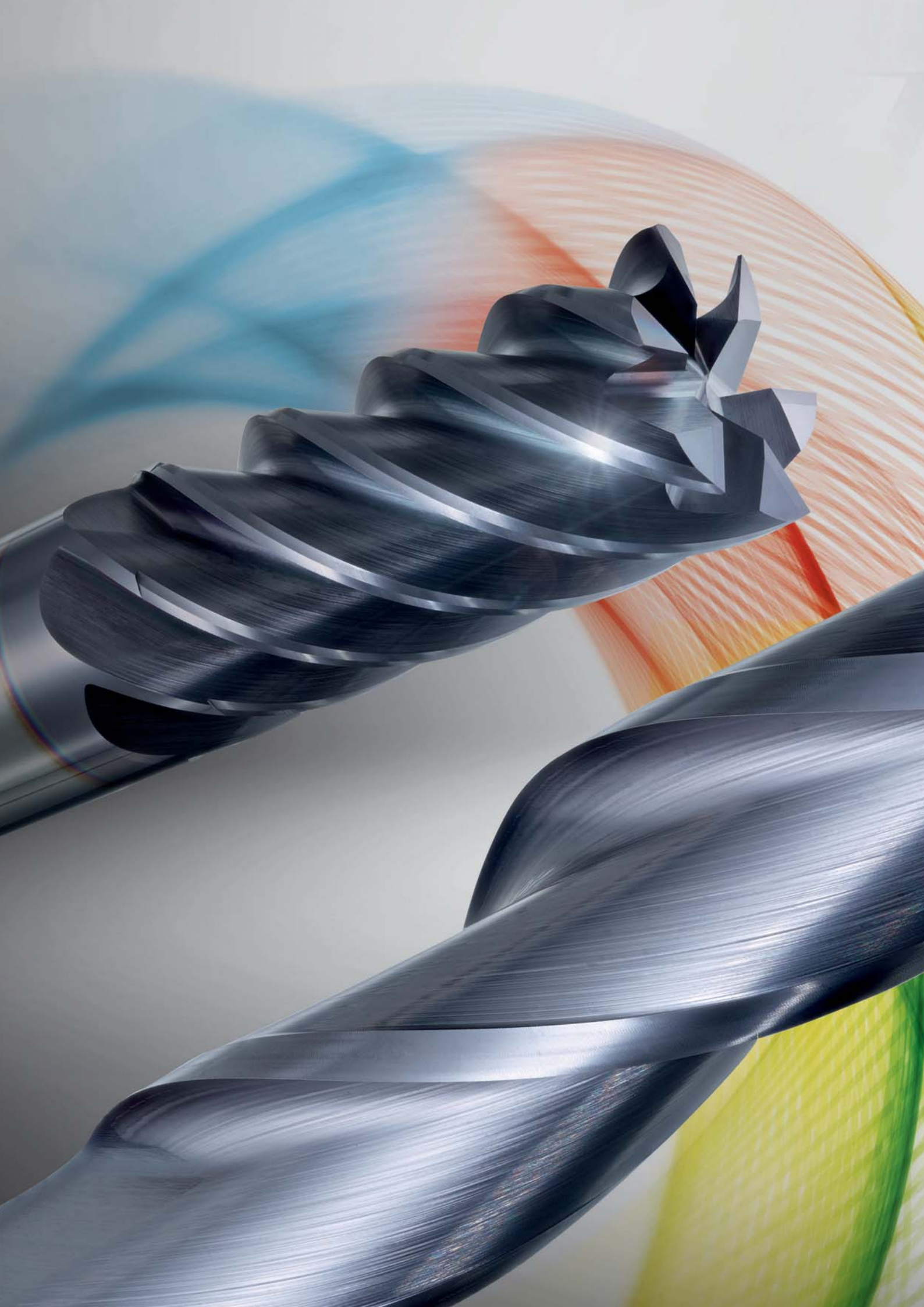

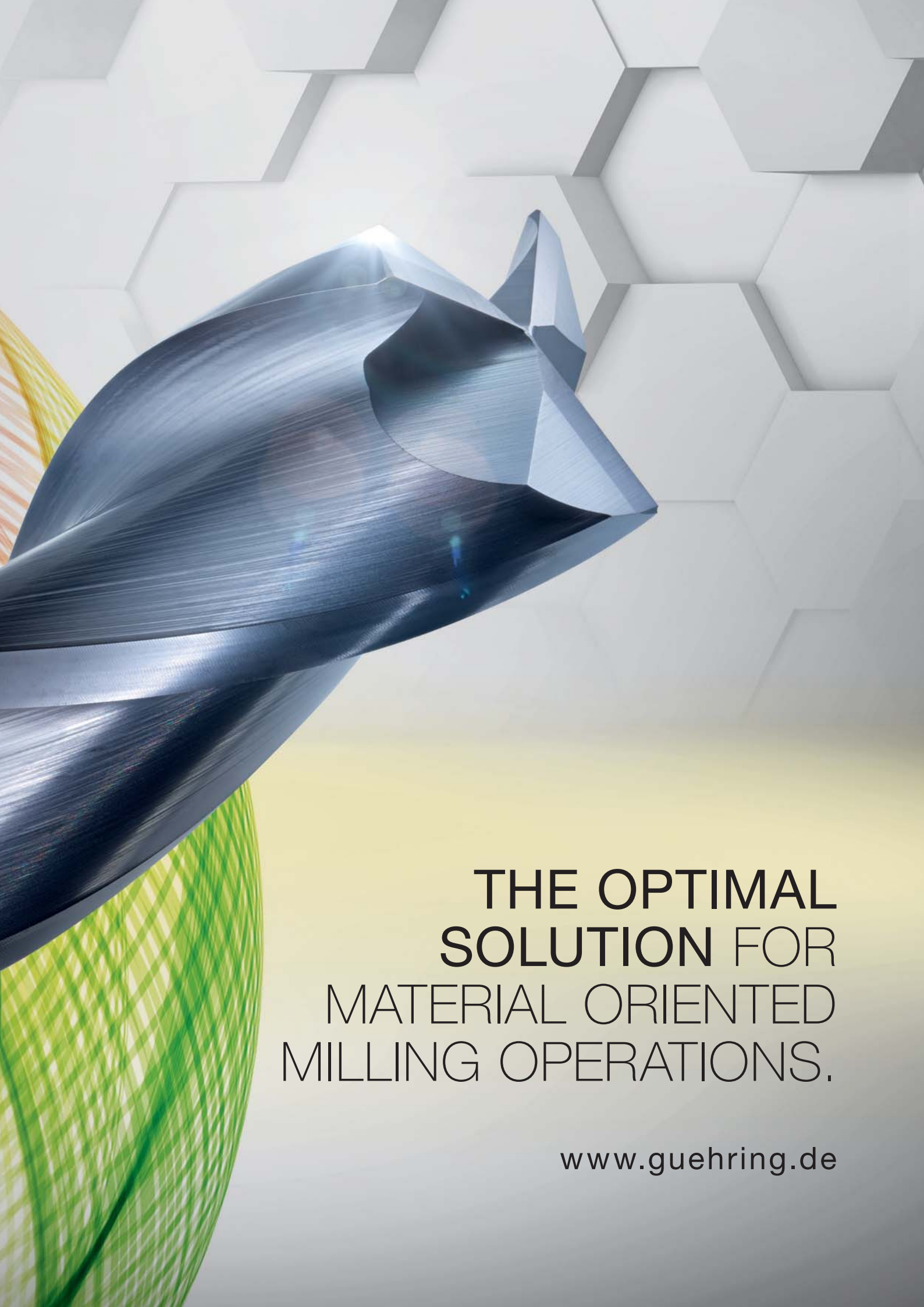

**THE OPTIMAL
SOLUTION FOR
MATERIAL ORIENTED
MILLING OPERATIONS.**

www.guehring.de

Applications overview



HPC

HSC



V_c

f_z

Allrounder

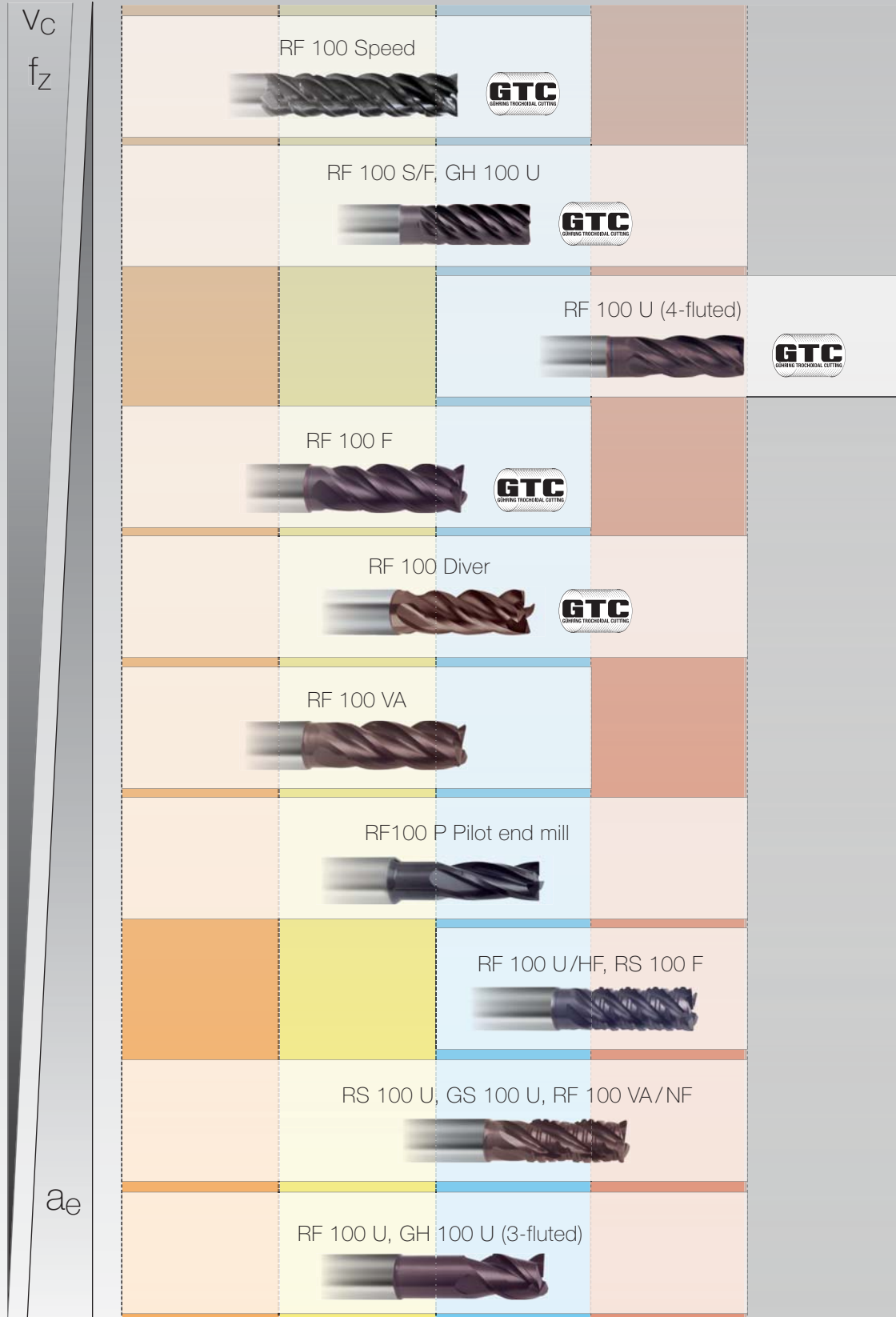

a_e

MTC



Titanium, special alloys



Stainless steel



Steel



Cast iron



Hardened steel

The overview assists in allocating Guhring's high-performance milling cutters for the material and strategy selection:
 The tools arranged below are for conventional milling with increased feed and low cutting data. The higher up the tools are arranged the lower the lateral feed. However, maximum cutting values are applied.

Specialists

HPC

HSC

V_c

f_z

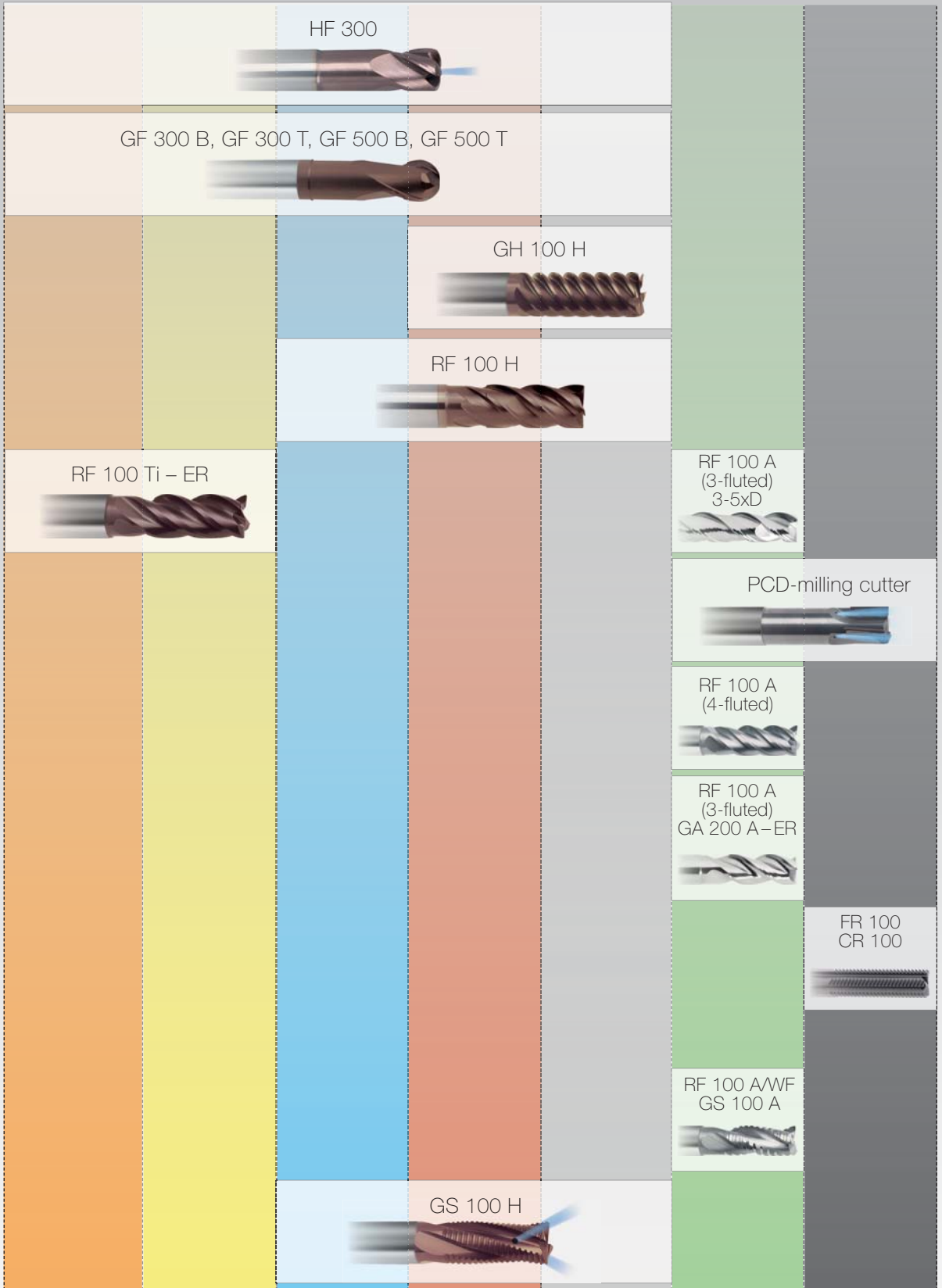

a_e

MTC



Titanium,
special alloys



Stainless
steel



Steel



Cast iron



Hardened
steel



Aluminium, non-ferrous
metals, plastics







































































































































CFK/Graphit

Chapter break-down into material classes

On the price and programme pages you will find suitability recommendations for every tool for the following application groups:

Application group	Material examples	Chapter
P	Steel, high-alloyed steel	Steel
M	Stainless steel	Stainless
K	Grey cast iron, spher, graphite/mall. cast iron	Steel
N	Aluminium and other non-ferrous metals	Aluminium and diamond
S	Special, super and titanium alloys	Stainless
H	Hardened steel and chilled cast iron	Steel and radius cutters
FK	Fibre plastic materials and graphite	Diamond

Pictograms

Application	 Slotting	 Roughing	 Ramping	 Helix	 Drilling	 Finishing	 Copying									
Milling conditions	 Trochoidal milling		 Maximum volume			 Maximum speed		 Non-rigid conditions								
Tool material	 Polycrystalline diamond		 Finest grain solid carbide (carbide-UF)				 High-speed steel	 								
Shank form	 HA	 -HA	 HB	 -HB	 HA/HB	 A	 B	 MK	 Cyl	 HSK-A						
	to DIN 6535					to DIN 1835		Morse taper	straight shank	HSK-A						
Standard	 DIN 327	 DIN 844K	 DIN 844L	 DIN 845	 DIN 850	 DIN 851	 DIN 885	 DIN 1833	 DIN 1880	 DIN 2328	 DIN 6518	 DIN 6527K	 DIN 6527L	 DIN 6528	 WN	
	to DIN														to Guhring std.	
Type	 W	 N	 NH	 H	 HF	 NF	 WF	 WR	 NR	 NRf	 HR	 HRf	 PF1000 G	 GF 200	 EW 100 VR	
	Application range similar to DIN 1836															
Length	 short (DIN)	 long (DIN)	 medium length	 extra length				 3xD	 4xD	 5xD						
No. of cutting edges	 1	 2	 3	 3-6	 4	 4-5	 4-6	 4-8	 5	 5-6	 6	 6+				
	no. of major cutting edges															
Helix angle	 30° 29° 31°	 30° 32°	 35° 38°	 36° 38° 37°	 36° 40° 41°	 39° 40° 42°	 40° 43° 45°	 41° 43° 45°	 44° 45° 46°	 0°	 2-4°	 7°	 20°	 30°	 45°
	Size of helix angle / no. of different helix angles															
Cutting edge form	 45°	 90°	 R±0,01						 R±0,02	 R±0,05	 R±0,01	 R±0,02	 R±0,05	 60°	 90°	 120°
	Corner chamfer		Radius with tolerance						Chamfer end mill angles							
Feed	 lateral feed	 lateral feed and oblique plunging						 lateral feed, oblique plunging and drilling								
Rake angle	 -15°	 -7°	 0°	 3°	 4°	 5°	 6°	 7°	 8°	 9°	 10°	 11°	 12°	 15°	 25°	
	Rake angle of circumference cutting edges															
Hardness	 48 HRC	 55 HRC	 63 HRC	workable material hardness in HRC												
Surface	 bright	 TiAlN	 TiAlN SuperA	 TiAlN nanoA	 FIRE	 TiCN	 Raptor	 Signum	 Cristall	 browned	 nickel-plated					

SELECT AND ORDER

This milling cutter catalogue is clearly arranged into manageable chapters for a quick and reliable selection of the optimal milling cutter.

- ▶ Material classes
- ▶ Fields of application
- ▶ Quick finder
- ▶ Navigator cutting data

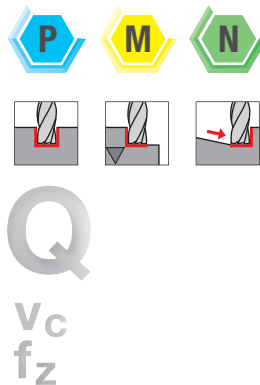

When ordering please always state the **Article no. and the code no.**, i.e.:
 “Ratio milling end mill standard RF 100 U,
 for nom.-Ø 3.00 mm” = **3731 3.000**

STEEL, CAST AND HARDENED STEEL

Standard Ratio end mills RF 100 U

DIN 6527 K **N** **SS** **4** **35°** **38°** **45°** **4°** **48 HRC**

P • **GUHRING NAVIGATOR**
M • Cutting data page 326
K •
N •
S •
H ○ • neck clearance
 • centre cutting

Tool material	Solid carbide	
Surface	F	F
Type	N	N
Shank form	HA	HB

Stahl, Guss und gehärteter Stahl

d1 h10	d2 h6	d3	l1	l2	l3	c	Z
mm	mm	mm	mm	mm	mm	mm x 45°	
3.00	6.00	2.80	50	5.0	12.0	0.10	4
4.00	6.00	3.80	54	8.0	15.0	0.10	4
5.00	6.00	4.80	54	9.0	15.0	0.10	4

Article no. **6706** **3731**

Code no.

3.000
4.000
5.000

Article no.

Code no.

Re-production – even in part – is not permitted.

Possible misprints or any type of intermediate changes do not entitle to any claims. All DIN marked products can be supplied deviating from the catalogue dimensions as long as they correspond to the specified DIN standard.

Printed in Germany

Guhring KG
 P.O. Box 10 02 47 · D-72423 Albstadt
 Herderstrasse 50-54 · D-72458 Albstadt
 Tel.: +49 74 31 17-0
 Fax: +49 74 31 17-21 279
 Internet: www.guehring.de
 E-Mail: info@guehring.de

MILLING CUTTER SELECTION MADE EASY

Looking for a high-performance milling cutter for roughing operations in steel? This is how you will find it:

1 Material selection
Quickfinder

- P** Steel
- M** Stainless steel
- N** Aluminium

2 Application

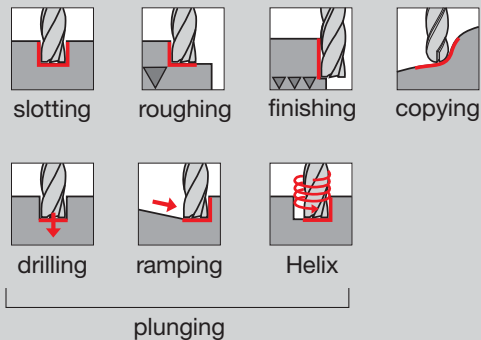

Steel, aluminium, stainless steel? No matter what material you are machining, we have a suitable tool. Start with the material selection!

Want your milling cutters for roughing operations or even plunging? No problem. Select the column for the required application!

1

Steel, cast as well as hardened steels

Steel, cast and hardened steel

2

	SLOTTING	ROUGHING	PLUNGING
NO.1	M7C P	M7C P	M7C P
	NSC M7C P K	HPC P K <i>i</i> machining a_e up to 0.3xD	NO.1 HPC P K ramping up to 45° Helix up to a_p 0.2xD
	HPC P K from approx. \varnothing 8.00 mm	NO.1 HPC P K <i>i</i> machining a_e up to 0.25xD	

3

3 Milling conditions

HPC maximum machining volume

HSC highest speed

MTC non-rigid conditions

Non-rigid conditions or high-performance cutting? Depending on machine conditions and cutting parameters then take your present milling conditions into consideration!

4 the ideal milling cutter



Article no. 3732

You have found your ideal milling cutter and are referred to the appropriate page in the catalogue with dimensions and cutting data.

FINISHING

COPYING

QUICK FINDER

Steel, cast and hardened steel



RF 100 U / GH100 U Z=3



i.e.: No. 3891 from p. 16

RF 100 Diver / RF 100 F



i.e.: No. 6737 from p. 26

RF 100 U Z=4 / Raptor



i.e.: No. 3732/6726 from p. 35

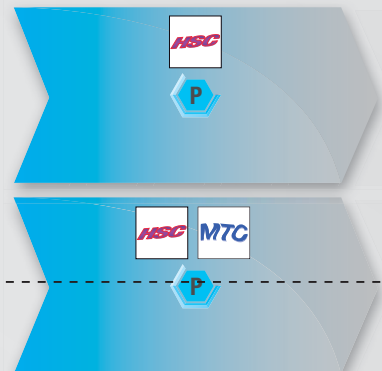

Copying milling cutters from p. 171

4







Solid carbide high-performance HPC milling cutters

-  for steel
-  for cast iron
-  for hardened steel

STEEL

Page 11

Solid carbide high-performance HPC milling cutters

-  for stainless steel
-  for titanium and difficult-to-machine alloys

STAINLESS

Page 71

Solid carbide high-performance HPC milling cutters

-  for aluminium, non-ferrous metals and plastics

ALUMINIUM

Page 113

Diamond / PCD milling cutters



Page 139

Solid carbide HSC radius milling cutters



Page 171

Solid carbide universal milling cutters



Page 219

High-performance milling cutters HSS-E PM Universal milling cutters M42



Page 281

Navigator cutting data Technical information Article no. index



Page 325

Application example

HPC roughing

Dry machining in steel 16MnCr5 (1.7131)

RF100 U 16 mm; Article no. 3732 16.0

$a_e = 4 \text{ mm} / a_p = 30 \text{ mm}$

$v_c = 280 \text{ m/min}$

$f_z = 0.13 \text{ mm}$

$v_f = 2896 \text{ mm/min}$

Metal removal rate $Q = 347 \text{ cm}^3/\text{min}$

HPC slotting

Wet machining in steel 42CrMo4 (1.7225)

RF100 Diver 11.7 mm; Article no. 6736 11.7

$a_e = 11,7 \text{ mm} / a_p = 12 \text{ mm}$

$v_c = 240 \text{ m/min}$

$f_z = 0.069 \text{ mm}$

$v_f = 1800 \text{ mm/min}$

Metal removal rate $Q = 252 \text{ cm}^3/\text{min}$

OCEL
ACERO
TERÄS
STEEL
ACIER
ACCIAIO



STEEL

SOLID CARBIDE HPC HIGH-PERFORMANCE MILLING CUTTER

for steel, cast iron and hardened steel



Steel, cast iron as well as hardened steel

Steel, cast iron and hardened steel

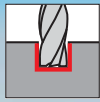

SLOTING

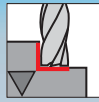

ROUGHING

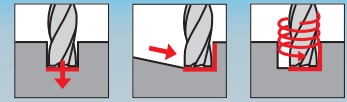

PLUNGING

NO.1

MTC

P

MTC

P

MTC

P

HSC **MTC**

P **K**

HPC

P **K**

*i*machining[®] a_e up to 0.3xD

NO.1

HPC

P **K**

ramping up to 45°
Helix up to a_p 0.2xD

HPC

P **K**

from approx. \varnothing 8.00 mm

NO.1

HPC

P **K**

*i*machining[®] a_e up to 0.25xD

MTC

P **K**

with GuhroJet up to a_p 2xD

HPC **MTC**

P **K**

MTC

P **K**

HPC

P

up to max. depth of 0.8xD

HPC

P

*i*machining[®] a_e up to 0.15xD

HPC

P

HPC

P

*i*machining[®] a_e up to 0.15xD

HPC

P

*i*machining[®] a_e up to 0.15xD

HPC

P **H**

up to 54 HRC

HPC

P **H**

with a_e up to 0.1xD
up to 63 HRC

HPC

P **H**

up to 54 HRC



GÜHRING TROCHOIDAL CUTTING
Dynamic / trochoidal milling



HIGH-PERFORMANCE CUTTING
for max. metal removal rates / time;
rigid conditions, high performance,
good cooling, quick de-clamping



HIGH SPEED CUTTING
with high speeds / high feed rate
low performance, low feed rate



Steel, cast iron and hardened steel

QUICK FINDER

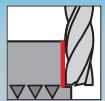

FINISHING

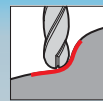

COPYING



Copying milling cutters from p. 171

HSC
P

HSC MTC
P

HSC
P H

NO.1
HSC
P

HSC
P H
up to 63 HRC

RF 100 U / GH100 U Z=3



i.e.: No. 3891 from p. 16

RF 100 Diver / RF 100 F



i.e.: No. 6737 from p. 26

RF 100 U Z=4 / Raptor



i.e.: No. 3732/6726 from p. 35

RF 100 U HF / RS 100 U



i.e.: No. 6881 from p. 44

RF100 Speed



i.e.: No. 6765/6766 from p. 31

RF 100 SF



i.e.: No. 6709/3631 from p. 52

RF 100 H / GF300 T



i.e.: No. 3895 from p. 61



MILL TURN CENTER driven tools
non-rigid conditions, low drive power
medium to long de-clamping, moderate cooling



STEEL



CAST



HARDENED STEEL



IDEAL TOOL

EXPLANATIONS
for the Quickfinder see p. 6-7

RF 100 U – High-performance end mills for materials up to 1400 N/mm²

Ratio®



large chip chambers
for outstanding chip evacuation
when slotting and plunging

low power consumption
3-fluted Ratio end mill with unequal helix angles
41°/43°/54° for increased feeds
and especially light cut on lighter machines

faster plunging
with new face geometry for

**3-fluted
RF 100 U and GH 100 U**

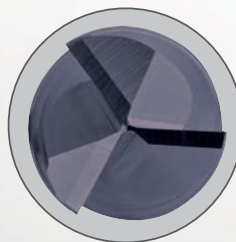

symmetrical drilling face with
large chip chambers for drilling and
ramping operations



micro-comer protection
for longer tool life



Standard Ratio end mills RF 100 U (3-fluted)

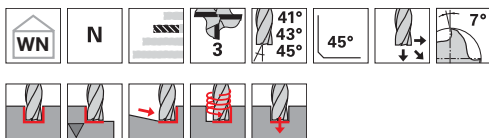

- P** •
- M** •
- K** •
- N** •
- S** ○
- H** □

GUHRING NAVIGATOR

Cutting data page 328

- neck clearance
- centre cutting

Tool material **Solid carbide**

Surface	F	F
Type	N	N
Shank form	HA	HB

Steel, cast iron and hardened steel

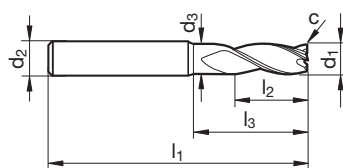

Article no. **3893** **3894**

d1 e8	d2 h6	d3	l1	l2	l3	c	Z	Code no.
mm	mm	mm	mm	mm	mm	mm x 45°		
3.00	6.00	2.80	57	4.0	15.0	0.05	3	3.000
4.00	6.00	3.80	57	5.0	18.0	0.06	3	4.000
5.00	6.00	4.80	57	6.0	18.0	0.08	3	5.000
6.00	6.00	5.70	57	7.0	20.0	0.09	3	6.000
8.00	8.00	7.70	63	9.0	26.0	0.12	3	8.000
10.00	10.00	9.50	72	11.0	30.0	0.15	3	10.000
12.00	12.00	11.50	83	12.0	36.0	0.18	3	12.000
16.00	16.00	15.50	92	16.0	42.0	0.19	3	16.000

ISO	Hardness	vc	fz (mm/z) / Ø								vc	fz (mm/z) / Ø							
			ap = 1,0 x D				ap = 1,0 x D					ap = 1,0 x D				ap max = 0,75 x D			
			3	6	8	10	12	16	20	3		6	8	10	12	16	20		
P	≤ 850 N/mm ²	180	0,016	0,031	0,042	0,060	0,07	0,10	0,12	210	0,018	0,036	0,048	0,069	0,08	0,11	0,14		
	≥ 850 N/mm ²	135	0,014	0,027	0,036	0,050	0,06	0,08	0,10	160	0,016	0,031	0,041	0,058	0,07	0,09	0,12		
M	≤ 750 N/mm ²	120	0,014	0,027	0,036	0,050	0,06	0,08	0,10	140	0,016	0,031	0,041	0,058	0,07	0,09	0,12		
	≥ 750 N/mm ²	60	0,011	0,021	0,028	0,040	0,05	0,06	0,08	80	0,013	0,025	0,034	0,048	0,06	0,08	0,10		
S	Ni-based	30	0,008	0,017	0,022	0,032	0,04	0,05	0,06	40	0,010	0,020	0,027	0,038	0,05	0,06	0,08		
	Ti-based	60	0,012	0,024	0,032	0,045	0,05	0,07	0,09	80	0,014	0,029	0,038	0,054	0,06	0,09	0,11		
N	≤ 5% Si	500	0,020	0,039	0,052	0,080	0,10	0,13	0,16	600	0,022	0,045	0,060	0,092	0,11	0,15	0,18		
	≥ 5% Si	230	0,017	0,033	0,044	0,060	0,07	0,10	0,12	300	0,019	0,038	0,051	0,069	0,08	0,11	0,14		

Standard Ratio end mills RF 100 U (3-fluted)

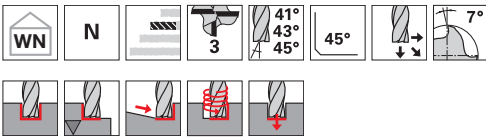

- P** •
- M** •
- K** •
- N** •
- S** ○
- H** □

GUHRING NAVIGATOR

Cutting data page 328

- neck clearance
- centre cutting

Tool material **Solid carbide**

Surface **F** **F**

Type **N** **N**

Shank form **HA** **HB**

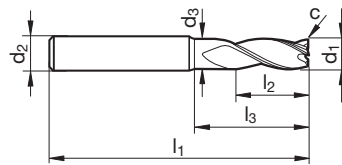

Article no. **3891** **3892**

d1 e8	d2 h6	d3	l1	l2	l3	c	Z	Code no.
mm	mm	mm	mm	mm	mm	mm x 45°		
3.00	6.00	2.80	57	8.0	15.0	0.05	3	3.000
3.50	6.00	3.30	57	10.0	15.0	0.05	3	3.500
3.70	6.00	3.50	57	11.0	15.0	0.06	3	3.700
4.00	6.00	3.80	57	11.0	18.0	0.06	3	4.000
4.50	6.00	4.30	57	11.0	18.0	0.07	3	4.500
4.70	6.00	4.50	57	13.0	18.0	0.07	3	4.700
5.00	6.00	4.80	57	13.0	18.0	0.08	3	5.000
5.50	6.00	5.30	57	13.0	19.4	0.08	3	5.500
5.70	6.00	5.50	57	13.0	19.6	0.09	3	5.700
6.00	6.00	5.70	57	13.0	20.0	0.09	3	6.000
6.50	8.00	6.20	63	16.0	24.4	0.10	3	6.500
7.00	8.00	6.70	63	16.0	24.9	0.11	3	7.000
7.50	8.00	7.20	63	19.0	25.3	0.11	3	7.500
8.00	8.00	7.70	63	19.0	26.0	0.12	3	8.000
8.50	10.00	8.20	72	19.0	29.4	0.13	3	8.500
9.00	10.00	8.70	72	19.0	29.9	0.14	3	9.000
9.50	10.00	9.20	72	22.0	30.3	0.14	3	9.500
10.00	10.00	9.50	72	22.0	30.0	0.15	3	10.000
12.00	12.00	11.50	83	26.0	36.0	0.18	3	12.000
16.00	16.00	15.50	92	32.0	42.0	0.19	3	16.000
20.00	20.00	19.50	104	38.0	52.0	0.24	3	20.000

ISO	Hardness	vc	fz (mm/z) / Ø							vc	fz (mm/z) / Ø							
			3	6	8	10	12	16	20		3	6	8	10	12	16	20	
P	≤ 850 N/mm ²	180	0,016	0,031	0,042	0,060	0,07	0,10	0,12		210	0,018	0,036	0,048	0,069	0,08	0,11	0,14
	≥ 850 N/mm ²	135	0,014	0,027	0,036	0,050	0,06	0,08	0,10			160	0,016	0,031	0,041	0,058	0,07	0,09
M	≤ 750 N/mm ²	120	0,014	0,027	0,036	0,050	0,06	0,08	0,10		140	0,016	0,031	0,041	0,058	0,07	0,09	0,12
	≥ 750 N/mm ²	60	0,011	0,021	0,028	0,040	0,05	0,06	0,08			80	0,013	0,025	0,034	0,048	0,06	0,08
S	Ni-based	30	0,008	0,017	0,022	0,032	0,04	0,05	0,06		40	0,010	0,020	0,027	0,038	0,05	0,06	0,08
	Ti-based	60	0,012	0,024	0,032	0,045	0,05	0,07	0,09			80	0,014	0,029	0,038	0,054	0,06	0,09
N	≤ 5% Si	500	0,020	0,039	0,052	0,080	0,10	0,13	0,16		600	0,022	0,045	0,060	0,092	0,11	0,15	0,18
	≥ 5% Si	230	0,017	0,033	0,044	0,060	0,07	0,10	0,12			300	0,019	0,038	0,051	0,069	0,08	0,11



Slot drills GH 100 U (3-fluted)

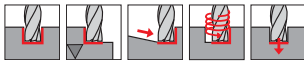

P • **GUHRING NAVIGATOR**
M • Cutting data page 330
K •
N ○
S ○
H ○
 • centre cutting

Tool material	Solid carbide	
Surface	○	Ⓡ
Type	NH	NH
Shank form	HA	HA

Steel, cast iron and hardened steel

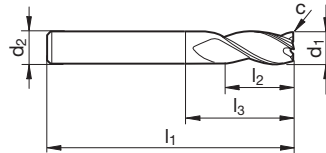

Article no. **3203** **3741**

d1 h10	d2 h6	l1	l2	l3	c	Z	Code no.
mm	mm	mm	mm	mm	mm x 45°		
2.00	2.00	32	6.0	8.0	0.03	3	2.000
2.50	2.50	32	7.0	9.0	0.04	3	2.500
3.00	3.00	38	7.0	10.0	0.05	3	3.000
3.50	3.50	50	7.0	22.0	0.05	3	3.500
4.00	4.00	50	8.0	22.0	0.06	3	4.000
4.50	4.50	50	8.0	22.0	0.07	3	4.500
5.00	5.00	50	10.0	22.0	0.08	3	5.000
5.50	5.50	57	10.0	21.0	0.08	3	5.500
6.00	6.00	57	10.0	21.0	0.09	3	6.000
6.50	6.50	60	13.0	24.0	0.10	3	6.500
7.00	7.00	60	13.0	24.0	0.11	3	7.000
7.50	7.50	63	16.0	27.0	0.11	3	7.500
8.00	8.00	63	16.0	27.0	0.12	3	8.000
8.50	8.50	67	16.0	27.0	0.13	3	8.500
9.00	9.00	67	16.0	27.0	0.14	3	9.000
9.50	9.50	72	19.0	32.0	0.14	3	9.500
10.00	10.00	72	19.0	32.0	0.15	3	10.000
11.00	11.00	83	22.0	38.0	0.17	3	11.000
12.00	12.00	83	22.0	38.0	0.18	3	12.000
13.00	13.00	83	22.0	38.0	0.20	3	13.000
14.00	14.00	83	22.0	38.0	0.21	3	14.000
15.00	15.00	92	26.0	44.0	0.23	3	15.000
16.00	16.00	92	26.0	44.0	0.19	3	16.000
18.00	18.00	92	26.0	44.0	0.22	3	18.000
20.00	20.00	104	32.0	54.0	0.24	3	20.000

ISO	Hardness	vc	fz (mm/z) / Ø						vc	fz (mm/z) / Ø							
			3	6	8	10	12	16		20	3	6	8	10	12	16	20
			ap = 1,0 x D			ae = 1,0 x D				ap = 1,0 x D			ae = 0,75 x D				
P	≤ 850 N/mm ²	120	0,012	0,024	0,032	0,045	0,05	0,07	0,09	140	0,014	0,028	0,037	0,052	0,06	0,08	0,10
	≥ 850 N/mm ²	90	0,011	0,023	0,030	0,042	0,05	0,07	0,08	110	0,013	0,026	0,035	0,048	0,06	0,08	0,10
M	≤ 750 N/mm ²	80	0,011	0,023	0,030	0,042	0,05	0,07	0,08	100	0,013	0,026	0,035	0,048	0,06	0,08	0,10
	≥ 750 N/mm ²	40	0,010	0,020	0,026	0,035	0,04	0,06	0,07	50	0,012	0,024	0,032	0,042	0,05	0,07	0,08
S	Ni-based	20	0,008	0,015	0,020	0,030	0,04	0,05	0,06	30	0,009	0,018	0,024	0,036	0,04	0,06	0,07
	Ti-based	40	0,010	0,020	0,026	0,038	0,05	0,06	0,08	50	0,012	0,024	0,032	0,046	0,05	0,07	0,09
K	≤ 240 HB	105	0,012	0,024	0,032	0,045	0,05	0,07	0,09	130	0,014	0,028	0,037	0,052	0,06	0,08	0,10
	≥ 240 HB	90	0,011	0,023	0,030	0,042	0,05	0,07	0,08	110	0,013	0,026	0,035	0,048	0,06	0,08	0,10

Please reduce cutting values for bright finish tools: vc -50% and fz -25%

Slot drills GH 100 U (3-fluted)

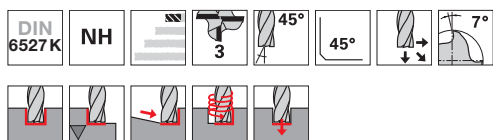

Tool material	Solid carbide	
Surface	○	Ⓡ
Type	NH	NH
Shank form	HA	HA

P • **GUHRING NAVIGATOR**
M • Cutting data page 330
K •
N ○
S ○
H • centre cutting

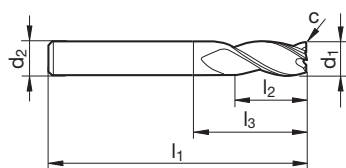

Article no. **3193** **3540**

d1 h10	d2 h6	l1	l2	l3	c	Z	Code no.
mm	mm	mm	mm	mm	mm x 45°		
3.00	6.00	50	4.0	7.9	0.05	3	3.000
4.00	6.00	54	5.0	8.9	0.06	3	4.000
5.00	6.00	54	6.0	11.4	0.08	3	5.000
6.00	6.00	54	7.0	18.0	0.09	3	6.000
7.00	8.00	58	8.0	16.4	0.11	3	7.000
8.00	8.00	58	9.0	22.0	0.12	3	8.000
9.00	10.00	66	10.0	19.4	0.14	3	9.000
10.00	10.00	66	11.0	26.0	0.15	3	10.000
12.00	12.00	73	12.0	28.0	0.18	3	12.000
14.00	14.00	75	14.0	30.0	0.21	3	14.000
16.00	16.00	82	16.0	34.0	0.19	3	16.000
18.00	18.00	84	18.0	36.0	0.22	3	18.000
20.00	20.00	92	20.0	42.0	0.24	3	20.000

ISO	Hardness	vc	fz (mm/z) / Ø							vc	fz (mm/z) / Ø							
			3	6	8	10	12	16	20		3	6	8	10	12	16	20	
P	≤ 850 N/mm ²	120	0,012	0,024	0,032	0,045	0,05	0,07	0,09		140	0,014	0,028	0,037	0,052	0,06	0,08	0,10
	≥ 850 N/mm ²	90	0,011	0,023	0,030	0,042	0,05	0,07	0,08		110	0,013	0,026	0,035	0,048	0,06	0,08	0,10
M	≤ 750 N/mm ²	80	0,011	0,023	0,030	0,042	0,05	0,07	0,08		100	0,013	0,026	0,035	0,048	0,06	0,08	0,10
	≥ 750 N/mm ²	40	0,010	0,020	0,026	0,035	0,04	0,06	0,07		50	0,012	0,024	0,032	0,042	0,05	0,07	0,08
S	Ni-based	20	0,008	0,015	0,020	0,030	0,04	0,05	0,06		30	0,009	0,018	0,024	0,036	0,04	0,06	0,07
	Ti-based	40	0,010	0,020	0,026	0,038	0,05	0,06	0,08		50	0,012	0,024	0,032	0,046	0,05	0,07	0,09
K	≤ 240 HB	105	0,012	0,024	0,032	0,045	0,05	0,07	0,09		130	0,014	0,028	0,037	0,052	0,06	0,08	0,10
	≥ 240 HB	90	0,011	0,023	0,030	0,042	0,05	0,07	0,08		110	0,013	0,026	0,035	0,048	0,06	0,08	0,10

Please reduce cutting values for bright finish tools: vc -50% and fz -25%



Slot drills GH 100 U (3-fluted)

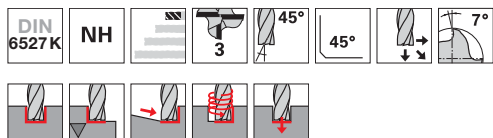

Tool material	Solid carbide
Surface	F
Type	NH
Shank form	HB

Steel, cast iron and hardened steel

P • **GUHRING NAVIGATOR**
M • Cutting data page 330
K •
N ○
S ○
H • centre cutting

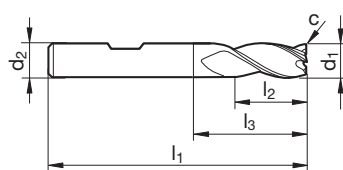

Article no. **3729**

d1 h10	d2 h6	l1	l2	l3	c	Z	Code no.
mm	mm	mm	mm	mm	mm x 45°		
3.00	6.00	50	4.0	7.9	0.05	3	3.000
4.00	6.00	54	5.0	8.9	0.06	3	4.000
5.00	6.00	54	6.0	11.4	0.08	3	5.000
6.00	6.00	54	7.0	18.0	0.09	3	6.000
7.00	8.00	58	8.0	16.4	0.11	3	7.000
8.00	8.00	58	9.0	22.0	0.12	3	8.000
9.00	10.00	66	10.0	19.4	0.14	3	9.000
10.00	10.00	66	11.0	26.0	0.15	3	10.000
12.00	12.00	73	12.0	28.0	0.18	3	12.000
14.00	14.00	75	14.0	30.0	0.21	3	14.000
16.00	16.00	82	16.0	34.0	0.19	3	16.000
18.00	18.00	84	18.0	36.0	0.22	3	18.000
20.00	20.00	92	20.0	42.0	0.24	3	20.000

ISO	Hardness	vc	fz (mm/z) / Ø							vc	fz (mm/z) / Ø							
			3	6	8	10	12	16	20		3	6	8	10	12	16	20	
P	≤ 850 N/mm ²	120	0,012	0,024	0,032	0,045	0,05	0,07	0,09		140	0,014	0,028	0,037	0,052	0,06	0,08	0,10
	≥ 850 N/mm ²	90	0,011	0,023	0,030	0,042	0,05	0,07	0,08			110	0,013	0,026	0,035	0,048	0,06	0,08
M	≤ 750 N/mm ²	80	0,011	0,023	0,030	0,042	0,05	0,07	0,08		100	0,013	0,026	0,035	0,048	0,06	0,08	0,10
	≥ 750 N/mm ²	40	0,010	0,020	0,026	0,035	0,04	0,06	0,07			50	0,012	0,024	0,032	0,042	0,05	0,07
S	Ni-based	20	0,008	0,015	0,020	0,030	0,04	0,05	0,06		30	0,009	0,018	0,024	0,036	0,04	0,06	0,07
	Ti-based	40	0,010	0,020	0,026	0,038	0,05	0,06	0,08			50	0,012	0,024	0,032	0,046	0,05	0,07
K	≤ 240 HB	105	0,012	0,024	0,032	0,045	0,05	0,07	0,09		130	0,014	0,028	0,037	0,052	0,06	0,08	0,10
	≥ 240 HB	90	0,011	0,023	0,030	0,042	0,05	0,07	0,08			110	0,013	0,026	0,035	0,048	0,06	0,08

Slot drills GH 100 U (3-fluted)

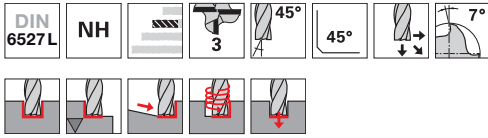

P • **GUHRING NAVIGATOR**
M • Cutting data page 330
K •
N ○
S ○
H • centre cutting

Tool material	Solid carbide	
Surface	○	Ⓡ
Type	NH	NH
Shank form	HA	HA

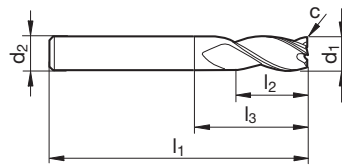

Article no. 3196 3636

d1 h10	d2 h6	l1	l2	l3	c	Z	Code no.
mm	mm	mm	mm	mm	mm x 45°		
1.00	3.00	38	2.0	3.4	0.02	3	1.000
1.50	3.00	38	3.0	5.9	0.02	3	1.500
2.00	6.00	57	6.0	8.9	0.03	3	2.000
2.50	6.00	57	7.0	9.9	0.04	3	2.500
3.00	6.00	57	7.0	10.9	0.05	3	3.000
3.50	6.00	57	7.0	10.9	0.05	3	3.500
4.00	6.00	57	8.0	11.9	0.06	3	4.000
4.50	6.00	57	8.0	13.4	0.07	3	4.500
5.00	6.00	57	10.0	15.4	0.08	3	5.000
6.00	6.00	57	10.0	21.0	0.09	3	6.000
7.00	8.00	63	13.0	21.4	0.11	3	7.000
8.00	8.00	63	16.0	27.0	0.12	3	8.000
9.00	10.00	72	16.0	25.4	0.14	3	9.000
10.00	10.00	72	19.0	32.0	0.15	3	10.000
12.00	12.00	83	22.0	38.0	0.18	3	12.000
14.00	14.00	83	22.0	38.0	0.21	3	14.000
14.00	16.00	92	26.0	37.4	0.21	3	14.001
16.00	16.00	92	26.0	44.0	0.19	3	16.000
18.00	18.00	92	26.0	44.0	0.22	3	18.000
18.00	20.00	104	32.0	46.0	0.22	3	18.001
20.00	20.00	104	32.0	54.0	0.24	3	20.000

ISO	Hardness	vc	fz (mm/z) / Ø						vc	fz (mm/z) / Ø							
			3	6	8	10	12	16		20	3	6	8	10	12	16	20
P	≤ 850 N/mm ²	120	0,012	0,024	0,032	0,045	0,05	0,07	0,09	140	0,014	0,028	0,037	0,052	0,06	0,08	0,10
	≥ 850 N/mm ²	90	0,011	0,023	0,030	0,042	0,05	0,07	0,08	110	0,013	0,026	0,035	0,048	0,06	0,08	0,10
M	≤ 750 N/mm ²	80	0,011	0,023	0,030	0,042	0,05	0,07	0,08	100	0,013	0,026	0,035	0,048	0,06	0,08	0,10
	≥ 750 N/mm ²	40	0,010	0,020	0,026	0,035	0,04	0,06	0,07	50	0,012	0,024	0,032	0,042	0,05	0,07	0,08
S	Ni-based	20	0,008	0,015	0,020	0,030	0,04	0,05	0,06	30	0,009	0,018	0,024	0,036	0,04	0,06	0,07
	Ti-based	40	0,010	0,020	0,026	0,038	0,05	0,06	0,08	50	0,012	0,024	0,032	0,046	0,05	0,07	0,09
K	≤ 240 HB	105	0,012	0,024	0,032	0,045	0,05	0,07	0,09	130	0,014	0,028	0,037	0,052	0,06	0,08	0,10
	≥ 240 HB	90	0,011	0,023	0,030	0,042	0,05	0,07	0,08	110	0,013	0,026	0,035	0,048	0,06	0,08	0,10

Please reduce cutting values for bright finish tools: vc -50% and fz -25%



Slot drills GH 100 U (3-fluted)

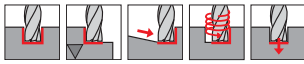

P • **GUHRING NAVIGATOR**
M • Cutting data page 330
K •
N ○
S ○
H • centre cutting

Tool material	Solid carbide
Surface	F
Type	NH
Shank form	HB

Steel, cast iron and hardened steel

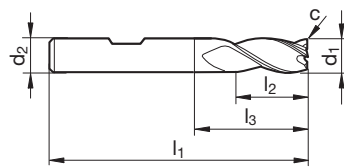

Article no. **3730**

d1 h10	d2 h6	l1	l2	l3	c	Z	Code no.
mm	mm	mm	mm	mm	mm x 45°		
3.00	6.00	57	7.0	10.9	0.05	3	3.000
3.50	6.00	57	7.0	10.9	0.05	3	3.500
4.00	6.00	57	8.0	11.9	0.06	3	4.000
4.50	6.00	57	8.0	13.4	0.07	3	4.500
5.00	6.00	57	10.0	15.4	0.08	3	5.000
6.00	6.00	57	10.0	21.0	0.09	3	6.000
7.00	8.00	63	13.0	21.4	0.11	3	7.000
8.00	8.00	63	16.0	27.0	0.12	3	8.000
9.00	10.00	72	16.0	25.4	0.14	3	9.000
10.00	10.00	72	19.0	32.0	0.15	3	10.000
12.00	12.00	83	22.0	38.0	0.18	3	12.000
14.00	14.00	83	22.0	38.0	0.21	3	14.000
16.00	16.00	92	26.0	44.0	0.19	3	16.000
18.00	18.00	92	26.0	44.0	0.22	3	18.000
20.00	20.00	104	32.0	54.0	0.24	3	20.000

ISO	Hardness	vc	fz (mm/z) / Ø							vc	fz (mm/z) / Ø							
			3	6	8	10	12	16	20		3	6	8	10	12	16	20	
P	≤ 850 N/mm ²	120	0,012	0,024	0,032	0,045	0,05	0,07	0,09		140	0,014	0,028	0,037	0,052	0,06	0,08	0,10
	≥ 850 N/mm ²	90	0,011	0,023	0,030	0,042	0,05	0,07	0,08			110	0,013	0,026	0,035	0,048	0,06	0,08
M	≤ 750 N/mm ²	80	0,011	0,023	0,030	0,042	0,05	0,07	0,08		100	0,013	0,026	0,035	0,048	0,06	0,08	0,10
	≥ 750 N/mm ²	40	0,010	0,020	0,026	0,035	0,04	0,06	0,07			50	0,012	0,024	0,032	0,042	0,05	0,07
S	Ni-based	20	0,008	0,015	0,020	0,030	0,04	0,05	0,06		30	0,009	0,018	0,024	0,036	0,04	0,06	0,07
	Ti-based	40	0,010	0,020	0,026	0,038	0,05	0,06	0,08			50	0,012	0,024	0,032	0,046	0,05	0,07
K	≤ 240 HB	105	0,012	0,024	0,032	0,045	0,05	0,07	0,09		130	0,014	0,028	0,037	0,052	0,06	0,08	0,10
	≥ 240 HB	90	0,011	0,023	0,030	0,042	0,05	0,07	0,08			110	0,013	0,026	0,035	0,048	0,06	0,08

Pilot end mills RF 100 P

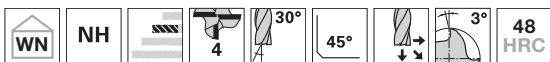

P ● **GUHRING NAVIGATOR**

M ○ Cutting data page 335

K ●

N ●

S ○ • for piloting, drilling, finishing

H ○ • special pilot geometry

• centre cutting

Tool material **Solid carbide**

Surface **A**

Type **NH**

Shank form **HA**

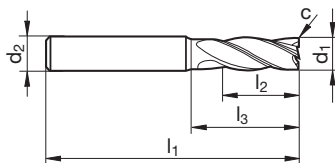

Article no. **6716**

d1 m8	d2 h6	l1	l2	l3	c	Z	Code no.
mm	mm	mm	mm	mm	mm x 45°		
1.40	3.00	38	3.0	5.9	0.01	4	1.400
1.50	3.00	38	4.0	6.9	0.02	4	1.500
1.80	3.00	38	6.0	8.9	0.02	4	1.800
2.00	3.00	38	6.5	9.4	0.02	4	2.000
2.10	3.00	38	6.5	9.9	0.02	4	2.100
2.30	3.00	38	6.5	9.9	0.02	4	2.300
2.50	3.00	38	6.5	9.9	0.03	4	2.500
2.80	3.00	38	6.5	10.0	0.03	4	2.800
3.00	6.00	57	8.0	12.4	0.03	4	3.000
3.50	6.00	57	10.0	14.9	0.04	4	3.500
4.00	6.00	57	11.0	15.9	0.04	4	4.000
4.50	6.00	57	11.0	17.4	0.05	4	4.500
5.00	6.00	57	13.0	19.4	0.05	4	5.000
5.50	6.00	57	13.0	20.4	0.06	4	5.500
6.00	8.00	63	13.0	20.4	0.06	4	6.000
6.50	8.00	63	13.0	20.9	0.07	4	6.500
7.00	8.00	63	16.0	23.9	0.07	4	7.000
7.50	8.00	63	16.0	23.9	0.08	4	7.500
8.00	10.00	72	19.0	26.9	0.08	4	8.000
8.50	10.00	72	19.0	28.4	0.09	4	8.500
9.00	10.00	72	19.0	28.4	0.09	4	9.000
10.00	12.00	83	22.0	31.4	0.10	4	10.000
11.00	12.00	83	26.0	36.4	0.11	4	11.000
12.00	14.00	83	26.0	37.4	0.12	4	12.000

ISO	Hardness	vc	fz (mm/z) / Ø						vc	fz (mm/z) / Ø									
			3	6	8	10	12	16		20	3	6	8	10	12	16	20		
P	≤ 850 N/mm ²	135	0,008	0,016	0,021	0,030	0,036	0,048	0,060		ap = 1 x D ae = 1 x D	180	0,016	0,031	0,042	0,060	0,07	0,10	0,12
	≥ 850 N/mm ²	100	0,007	0,014	0,018	0,025	0,030	0,040	0,050				135	0,014	0,027	0,036	0,050	0,06	0,08
M	≤ 750 N/mm ²	90	0,007	0,014	0,018	0,025	0,030	0,040	0,050		ap = l2 ae = 1 x D	120	0,014	0,027	0,036	0,050	0,06	0,08	0,10
	≥ 750 N/mm ²	45	0,005	0,011	0,014	0,020	0,024	0,032	0,040				60	0,011	0,021	0,028	0,040	0,05	0,06
S	Ni-based	25	0,004	0,008	0,011	0,016	0,019	0,026	0,032		ap = l2 ae = 1 x D	30	0,008	0,017	0,022	0,032	0,04	0,05	0,06
	Ti-based	45	0,006	0,012	0,016	0,023	0,027	0,036	0,045				60	0,012	0,024	0,032	0,045	0,05	0,07
K	≥ 240 HB	120	0,008	0,017	0,022	0,033	0,039	0,052	0,065		ap = l2 ae = 1 x D	160	0,017	0,033	0,044	0,065	0,08	0,10	0,13
	≥ 240 HB	105	0,008	0,015	0,020	0,028	0,033	0,044	0,055				140	0,015	0,030	0,040	0,055	0,07	0,09
N	≤ 7 % Si	375	0,010	0,020	0,026	0,040	0,048	0,064	0,080		ap = l2 ae = 1 x D	500	0,020	0,039	0,052	0,080	0,10	0,13	0,16
	≥ 7 % Si	175	0,008	0,017	0,022	0,030	0,036	0,048	0,060				230	0,017	0,033	0,044	0,060	0,07	0,10

Gühring TV

or scan in code and
watch video!



RF 100 *diver*



Drilling
Ramping
Roughing
Finishing
Slotting

///Ratio®///

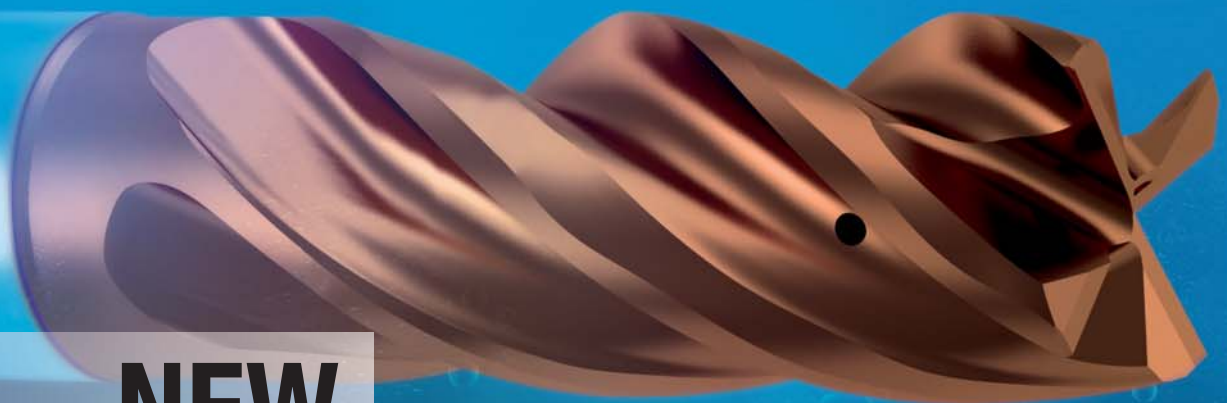

NEW

**EXTENDED PROGRAMME
AND INTERNAL COOLING**

Ratio end mills RF 100 DIVER (3-fluted)

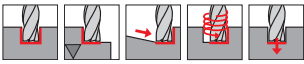

P • **GUHRING NAVIGATOR**

M • Cutting data page 326

K •

N •

S •

H •

- neck clearance
- centre cutting
- with special drill face

Tool material	Solid carbide	
Surface		
Type	NH	NH
Shank form	HA	HB

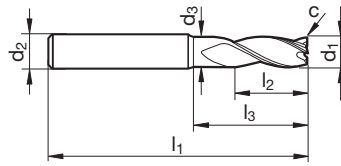

Article no. **6797** **6798**

d1 h10	d2 h6	d3	l1	l2	l3	c	Z	Code no.
mm	mm	mm	mm	mm	mm	mm x 45°		
3.00	6.00	2.80	57	8.0	15.0	0.05	3	3.000
3.50	6.00	3.30	57	10.0	15.0	0.05	3	3.500
3.70	6.00	3.50	57	11.0	15.0	0.06	3	3.700
4.00	6.00	3.80	57	11.0	18.0	0.06	3	4.000
4.50	6.00	4.30	57	11.0	18.0	0.07	3	4.500
4.70	6.00	4.50	57	13.0	18.0	0.07	3	4.700
5.00	6.00	4.80	57	13.0	18.0	0.08	3	5.000
5.50	6.00	5.30	57	13.0	19.4	0.08	3	5.500
5.70	6.00	5.50	57	13.0	19.6	0.09	3	5.700
6.00	6.00	5.70	57	13.0	20.0	0.09	3	6.000
6.50	8.00	6.20	63	16.0	24.4	0.10	3	6.500
7.00	8.00	6.70	63	16.0	24.9	0.11	3	7.000
7.50	8.00	7.20	63	19.0	25.3	0.11	3	7.500
8.00	8.00	7.70	63	19.0	26.0	0.12	3	8.000
8.50	10.00	8.20	72	19.0	29.4	0.13	3	8.500
9.00	10.00	8.70	72	19.0	29.9	0.14	3	9.000
9.50	10.00	9.20	72	22.0	30.3	0.14	3	9.500
10.00	10.00	9.50	72	22.0	30.0	0.15	3	10.000
12.00	12.00	11.50	83	26.0	36.0	0.18	3	12.000
16.00	16.00	15.50	92	32.0	42.0	0.19	3	16.000
20.00	20.00	19.50	104	38.0	52.0	0.24	3	20.000

ISO	Hardness	vc	fz (mm/z) / Ø							vc	fz (mm/z) / Ø							
			3	6	8	10	12	16	20		3	6	8	10	12	16	20	
P	≤ 850 N/mm ²	270	0,017	0,025	0,034	0,050	0,060	0,080	0,100		350	0,021	0,032	0,042	0,063	0,075	0,100	0,125
	≥ 850 N/mm ²	180	0,014	0,021	0,028	0,045	0,054	0,072	0,090		260	0,018	0,027	0,036	0,059	0,070	0,094	0,117
M	≤ 750 N/mm ²	120	0,014	0,021	0,028	0,045	0,054	0,072	0,090		160	0,018	0,027	0,036	0,059	0,070	0,094	0,117
	≥ 750 N/mm ²	80	0,013	0,019	0,026	0,040	0,048	0,064	0,080		120	0,019	0,029	0,038	0,060	0,072	0,096	0,120
S	Ti-based	60	0,013	0,019	0,026	0,040	0,048	0,064	0,080		110	0,017	0,025	0,033	0,052	0,062	0,083	0,104
K	≤ 240 HB	150	0,017	0,025	0,034	0,050	0,060	0,080	0,100		190	0,021	0,032	0,042	0,063	0,075	0,100	0,125
N	≥ 7% Si	340	0,018	0,027	0,036	0,055	0,066	0,088	0,110		440	0,023	0,034	0,045	0,069	0,083	0,110	0,138



Ratio end mills RF 100 DIVER

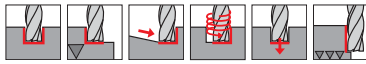
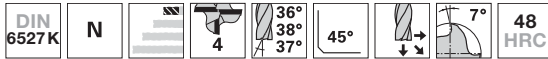

P • **GUHRING NAVIGATOR**
M • Cutting data page 326
K •
N •
S •
H ○ • neck clearance
 • centre cutting

Tool material	Solid carbide	
Surface	Y	Y
Type	N	N
Shank form	HA	HB

Steel, cast iron and hardened steel

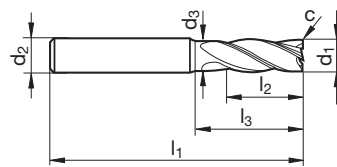

								Article no.	6803	6804
d1 h10	d2 h6	d3	l1	l2	l3	c	Z	Code no.		
mm	mm	mm	mm	mm	mm	mm x 45°				
3.00	6.00	2.80	50	5.0	12.0	0.03	4	3.000		
3.70	6.00	3.50	54	8.0	12.0	0.04	4	3.700		
4.00	6.00	3.80	54	8.0	15.0	0.04	4	4.000		
4.70	6.00	4.50	54	9.0	15.0	0.05	4	4.700		
5.00	6.00	4.80	54	9.0	15.0	0.05	4	5.000		
5.70	6.00	5.50	54	10.0	16.6	0.06	4	5.700		
6.00	6.00	5.70	54	10.0	17.0	0.06	4	6.000		
7.00	8.00	6.70	58	11.0	19.9	0.07	4	7.000		
7.70	8.00	7.40	58	12.0	20.5	0.08	4	7.700		
8.00	8.00	7.70	58	12.0	21.0	0.08	4	8.000		
9.00	10.00	8.70	66	13.0	23.9	0.09	4	9.000		
9.70	10.00	9.40	66	14.0	24.5	0.10	4	9.700		
10.00	10.00	9.50	66	14.0	24.0	0.10	4	10.000		
11.70	12.00	11.20	73	16.0	25.3	0.12	4	11.700		
12.00	12.00	11.50	73	16.0	26.0	0.12	4	12.000		
15.60	16.00	15.10	82	22.0	31.2	0.16	4	15.600		
16.00	16.00	15.50	82	22.0	32.0	0.16	4	16.000		
19.00	20.00	18.50	92	26.0	38.7	0.19	4	19.000		
20.00	20.00	19.50	92	26.0	40.0	0.20	4	20.000		

ISO	Hardness	vc	fz (mm/z) / Ø							vc	fz (mm/z) / Ø						
			3	6	8	10	12	16	20		3	6	8	10	12	16	20
			ap = 1,0 x D				ae = 1,0 x D				ap = l2				ae max = 0,20 x D		
P	≤ 850 N/mm ²	270	0,017	0,025	0,034	0,050	0,060	0,080	0,100	450	0,027	0,040	0,054	0,080	0,10	0,13	0,16
	≥ 850 N/mm ²	180	0,014	0,021	0,028	0,045	0,054	0,072	0,090	300	0,022	0,034	0,045	0,072	0,09	0,12	0,14
M	≤ 750 N/mm ²	120	0,014	0,021	0,028	0,045	0,054	0,072	0,090	200	0,022	0,034	0,045	0,072	0,09	0,12	0,14
	≥ 750 N/mm ²	80	0,013	0,019	0,026	0,040	0,048	0,064	0,080	140	0,020	0,031	0,041	0,064	0,08	0,10	0,13
S	Ti-based	60	0,013	0,019	0,026	0,040	0,048	0,064	0,080	110	0,020	0,031	0,041	0,064	0,08	0,10	0,13
K	≤ 240 HB	150	0,017	0,025	0,034	0,050	0,060	0,080	0,100	250	0,027	0,040	0,054	0,080	0,10	0,13	0,16
N	≥ 7% Si	340	0,018	0,027	0,036	0,055	0,066	0,088	0,110	570	0,029	0,043	0,058	0,088	0,11	0,14	0,18

Ratio end mills RF 100 DIVER

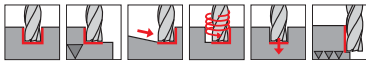
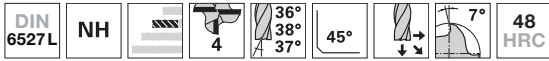

P • **GUHRING NAVIGATOR**
M • Cutting data page 326
K •
N •
S •
H ○ • neck clearance
 • centre cutting

Tool material	Solid carbide	
Surface	Y	Y
Type	NH	NH
Shank form	HA	HB

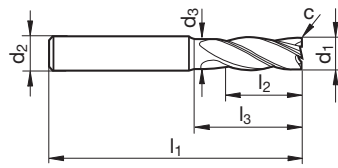

Article no. **6737** **6736**

d1 h10	d2 h6	d3	l1	l2	l3	c	Z	Code no.
mm	mm	mm	mm	mm	mm	mm x 45°		
4.00	6.00	3.80	57	11.0	18.0	0.04	4	4.000
5.00	6.00	4.80	57	13.0	18.0	0.05	4	5.000
5.70	6.00	5.50	57	13.0	19.6	0.06	4	5.700
6.00	6.00	5.70	57	13.0	20.0	0.06	4	6.000
7.70	8.00	7.40	63	19.0	25.5	0.08	4	7.700
8.00	8.00	7.70	63	19.0	26.0	0.08	4	8.000
9.70	10.00	9.40	72	22.0	30.5	0.10	4	9.700
10.00	10.00	9.50	72	22.0	30.0	0.10	4	10.000
11.70	12.00	11.20	83	26.0	35.3	0.12	4	11.700
12.00	12.00	11.50	83	26.0	36.0	0.12	4	12.000
13.70	14.00	13.20	83	26.0	35.3	0.14	4	13.700
14.00	14.00	13.50	83	26.0	36.0	0.14	4	14.000
15.60	16.00	15.10	92	32.0	41.2	0.16	4	15.600
16.00	16.00	15.50	92	32.0	42.0	0.16	4	16.000
19.50	20.00	19.00	104	38.0	51.1	0.20	4	19.500
20.00	20.00	19.50	104	38.0	52.0	0.20	4	20.000

ISO	Hardness	vc	fz (mm/z) / Ø							vc	fz (mm/z) / Ø							
			3	6	8	10	12	16	20		3	6	8	10	12	16	20	
P	≤ 850 N/mm ²	270	0,017	0,025	0,034	0,050	0,060	0,080	0,100		450	0,027	0,040	0,054	0,080	0,10	0,13	0,16
	≥ 850 N/mm ²	180	0,014	0,021	0,028	0,045	0,054	0,072	0,090			300	0,022	0,034	0,045	0,072	0,09	0,12
M	≤ 750 N/mm ²	120	0,014	0,021	0,028	0,045	0,054	0,072	0,090		200	0,022	0,034	0,045	0,072	0,09	0,12	0,14
	≥ 750 N/mm ²	80	0,013	0,019	0,026	0,040	0,048	0,064	0,080			140	0,020	0,031	0,041	0,064	0,08	0,10
S	Ti-based	60	0,013	0,019	0,026	0,040	0,048	0,064	0,080		110	0,020	0,031	0,041	0,064	0,08	0,10	0,13
K	≤ 240 HB	150	0,017	0,025	0,034	0,050	0,060	0,080	0,100			250	0,027	0,040	0,054	0,080	0,10	0,13
N	≥ 7% Si	340	0,018	0,027	0,036	0,055	0,066	0,088	0,110		570	0,029	0,043	0,058	0,088	0,11	0,14	0,18



Ratio end mills RF 100 F

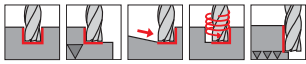

GUHRING NAVIGATOR
Cutting data page 328

P	•
M	•
K	
N	○
S	•
H	

- neck clearance
- centre cutting

Tool material	Solid carbide	
Surface	F	F
Type	NH	NH
Shank form	HA	HB



Steel, cast iron and hardened steel

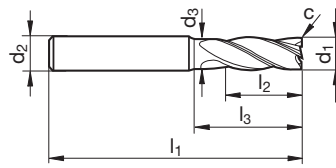

Article no. 3629 3630

d1 h10	d2 h6	d3	l1	l2	l3	c	Z	Code no.
mm	mm	mm	mm	mm	mm	mm x 45°		
4.00	6.00	3.80	57	11.0	18.0	0.10	4	4.000
5.00	6.00	4.80	57	13.0	18.0	0.10	4	5.000
6.00	6.00	5.70	57	13.0	20.0	0.15	4	6.000
8.00	8.00	7.70	63	19.0	26.0	0.15	4	8.000
10.00	10.00	9.50	72	22.0	30.0	0.20	4	10.000
12.00	12.00	11.50	83	26.0	36.0	0.20	4	12.000
16.00	16.00	15.50	92	32.0	42.0	0.35	4	16.000
20.00	20.00	19.50	104	38.0	52.0	0.45	4	20.000

ISO	Hardness	vc	fz (mm/z) / Ø								vc	fz (mm/z) / Ø							
			ap = 1,0 x D				ap = 1,0 x D					ap = l2				ap max = 0,2 x D			
			3	6	8	10	12	16	20	3		6	8	10	12	16	20		
P	≤ 850 N/mm ²	180	0,016	0,031	0,042	0,060	0,07	0,10	0,12	305	0,025	0,050	0,067	0,096	0,12	0,15	0,19		
	≥ 850 N/mm ²	135	0,014	0,027	0,036	0,050	0,06	0,08	0,10	230	0,022	0,043	0,058	0,080	0,10	0,13	0,16		
M	≤ 750 N/mm ²	120	0,014	0,027	0,036	0,050	0,06	0,08	0,10	205	0,022	0,043	0,058	0,080	0,10	0,13	0,16		
	≥ 750 N/mm ²	60	0,011	0,021	0,028	0,040	0,05	0,06	0,08	100	0,017	0,034	0,045	0,064	0,08	0,10	0,13		
S	Ni-based	30	0,008	0,017	0,022	0,032	0,04	0,05	0,06	50	0,013	0,027	0,036	0,051	0,06	0,08	0,10		
	Ti-based	60	0,012	0,024	0,032	0,045	0,05	0,07	0,09	100	0,019	0,038	0,051	0,072	0,09	0,12	0,14		

Ratio end mills RF 100 F

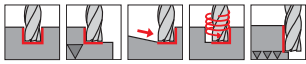

P • **GUHRING NAVIGATOR**

M • Cutting data page 328

- K**
- N** ○
- S** •
- H**

- with internal coolant supply
- neck clearance
- centre cutting

Tool material	Solid carbide
Surface	F
Type	NH
Shank form	HB

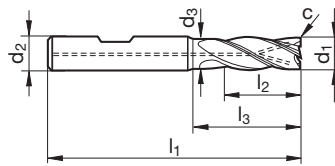

Article no. **3366**

d1 h10	d2 h6	d3	l1	l2	l3	c	Z	Code no.
mm	mm	mm	mm	mm	mm	mm x 45°		
6.00	6.00	5.70	57	13.0	20.0	0.15	4	6.000
8.00	8.00	7.70	63	19.0	26.0	0.15	4	8.000
10.00	10.00	9.50	72	22.0	30.0	0.20	4	10.000
12.00	12.00	11.50	83	26.0	36.0	0.20	4	12.000
16.00	16.00	15.50	92	32.0	42.0	0.35	4	16.000
20.00	20.00	19.50	104	38.0	52.0	0.45	4	20.000

ISO	Hardness	vc	fz (mm/z) / Ø							vc	fz (mm/z) / Ø						
			3	6	8	10	12	16	20		3	6	8	10	12	16	20
P	≤ 850 N/mm ²	180	0,016	0,031	0,042	0,060	0,07	0,10	0,12	305	0,025	0,050	0,067	0,096	0,12	0,15	0,19
	≥ 850 N/mm ²	135	0,014	0,027	0,036	0,050	0,06	0,08	0,10	230	0,022	0,043	0,058	0,080	0,10	0,13	0,16
M	≤ 750 N/mm ²	120	0,014	0,027	0,036	0,050	0,06	0,08	0,10	205	0,022	0,043	0,058	0,080	0,10	0,13	0,16
	≥ 750 N/mm ²	60	0,011	0,021	0,028	0,040	0,05	0,06	0,08	100	0,017	0,034	0,045	0,064	0,08	0,10	0,13
S	Ni-based	30	0,008	0,017	0,022	0,032	0,04	0,05	0,06	50	0,013	0,027	0,036	0,051	0,06	0,08	0,10
	Ti-based	60	0,012	0,024	0,032	0,045	0,05	0,07	0,09	100	0,019	0,038	0,051	0,072	0,09	0,12	0,14



Ratio end mills RF 100 F 90°

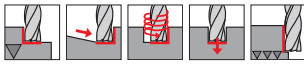

P • **GUHRING NAVIGATOR**
M • Cutting data page 328
K
N ○
S •
H
 • without corner protection chamfer
 • neck clearance
 • centre cutting

Tool material	Solid carbide
Surface	a
Type	NH
Shank form	HA



Steel, cast iron and hardened steel

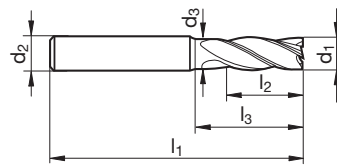

Article no. **6764**

d1 h10	d2 h6	d3	l1	l2	l3	Z	Code no.
mm	mm	mm	mm	mm	mm		
3.00	6.00	2.80	57	8.0	15.0	4	3.000
4.00	6.00	3.80	57	11.0	18.0	4	4.000
5.00	6.00	4.80	57	13.0	18.0	4	5.000
6.00	6.00	5.70	57	13.0	20.0	4	6.000
8.00	8.00	7.70	63	19.0	26.0	4	8.000
10.00	10.00	9.50	72	22.0	30.0	4	10.000
12.00	12.00	11.50	83	26.0	36.0	4	12.000
16.00	16.00	15.50	92	32.0	42.0	4	16.000
20.00	20.00	19.50	104	38.0	52.0	4	20.000

ISO	Hardness	vc	fz (mm/z) / Ø								vc	fz (mm/z) / Ø							
			3	6	8	10	12	16	20	3		6	8	10	12	16	20		
P	≤ 850 N/mm ²	340	0,036	0,072	0,096	0,138	0,17	0,22	0,28	360	0,017	0,034	0,046	0,066	0,08	0,11	0,13		
	≥ 850 N/mm ²	250	0,031	0,062	0,083	0,115	0,14	0,18	0,23	270	0,015	0,030	0,040	0,055	0,07	0,09	0,11		
M	≤ 750 N/mm ²	220	0,031	0,062	0,083	0,115	0,14	0,18	0,23	240	0,015	0,030	0,040	0,055	0,07	0,09	0,11		
	≥ 750 N/mm ²	110	0,024	0,048	0,064	0,092	0,11	0,15	0,18	120	0,011	0,021	0,028	0,040	0,05	0,06	0,08		
S	Ni-based	60	0,019	0,039	0,052	0,074	0,09	0,12	0,15	60	0,008	0,017	0,022	0,032	0,04	0,05	0,06		
	Ti-based	110	0,028	0,055	0,074	0,104	0,12	0,17	0,21	120	0,013	0,026	0,035	0,050	0,06	0,08	0,10		

RF 100 Speed
HPC milling in steel and VA

RF 100
SPEED

Ratio®



stable cutting edge corner
thanks to corner protection
chamfer and face correction
= **Double Protection!**



optimised chip gullet
deepened flute on front cutting
edge area for improved chip
evacuation

48° helix angle with unequal
cutting edge partitioning for soft,
quiet cut

Chip breaker



**Face geometry with large chip
gullets and improved web thinning
for minimum vibration plunging,
ramping and orbital milling.**



Ratio end mills RF 100 Speed

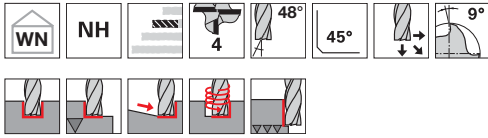

P	•
M	•
K	
N	
S	•
H	

GUHRING NAVIGATOR
Cutting data page 327

- roughing operations of up to max. 0.8xD depth
- re-inforced core from Ø 6 mm
- centre cutting

Tool material	Solid carbide	
Surface	A	A
Type	NH	NH
Shank form	HA	HB



Steel, cast iron and hardened steel

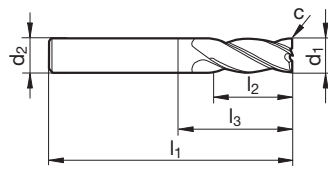

Article no. **6765** **6760**

d1 h10	d2 h6	l1	l2	l3	c	Z	Code no.
mm	mm	mm	mm	mm	mm x 45°		
3.00	6.00	57	8.0	11.4	0.04	4	3.000
4.00	6.00	57	11.0	14.9	0.06	4	4.000
5.00	6.00	57	13.0	16.9	0.07	4	5.000
6.00	6.00	57	15.0	21.0	0.09	4	6.000
8.00	8.00	63	20.0	27.0	0.12	4	8.000
10.00	10.00	72	24.0	32.0	0.15	4	10.000
12.00	12.00	83	28.0	38.0	0.18	4	12.000
16.00	16.00	92	36.0	44.0	0.24	4	16.000
20.00	20.00	104	45.0	54.0	0.30	4	20.000

ISO	Hardness	vc	fz (mm/z) / Ø								vc	fz (mm/z) / Ø							
			3	6	8	10	12	16	20	3		6	8	10	12	16	20		
P	≤ 850 N/mm ²	340	0,036	0,072	0,096	0,138	0,17	0,22	0,28		ae max. = 0,10 x D	360	0,017	0,034	0,046	0,066	0,08	0,11	0,13
	≥ 850 N/mm ²	250	0,031	0,062	0,083	0,115	0,14	0,18	0,23			270	0,015	0,030	0,040	0,055	0,07	0,09	0,11
M	≤ 750 N/mm ²	220	0,031	0,062	0,083	0,115	0,14	0,18	0,23		ae max. = 0,02 x D	240	0,015	0,030	0,040	0,055	0,07	0,09	0,11
	≥ 750 N/mm ²	110	0,024	0,048	0,064	0,092	0,11	0,15	0,18			120	0,011	0,021	0,028	0,040	0,05	0,06	0,08
S	Ni-based	60	0,019	0,039	0,052	0,074	0,09	0,12	0,15		ae max. = 0,02 x D	60	0,008	0,017	0,022	0,032	0,04	0,05	0,06
	Ti-based	110	0,028	0,055	0,074	0,104	0,12	0,17	0,21			120	0,013	0,026	0,035	0,050	0,06	0,08	0,10

Ratio end mills RF 100 Speed

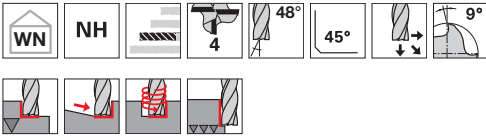

P	•
M	•
K	
N	
S	•
H	

GUHRING NAVIGATOR

Cutting data page 327

- with chip breaker
- re-inforced core from Ø 6 mm
- centre cutting

Tool material	Solid carbide	
Surface	A	A
Type	NH	NH
Shank form	HA	HB

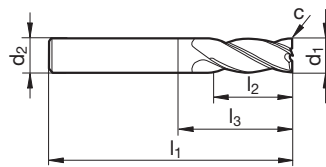

Article no. **6766** **6761**

d1 h10	d2 h6	l1	l2	l3	c	Z	Code no.
mm	mm	mm	mm	mm	mm x 45°		
3.00	6.00	57	12.0	14.9	0.04	4	3.000
4.00	6.00	65	16.0	18.9	0.06	4	4.000
5.00	6.00	65	20.0	22.9	0.07	4	5.000
6.00	6.00	65	24.0	29.0	0.09	4	6.000
8.00	8.00	75	32.0	39.0	0.12	4	8.000
10.00	10.00	90	40.0	50.0	0.15	4	10.000
12.00	12.00	100	46.0	55.0	0.18	4	12.000
16.00	16.00	108	55.0	60.0	0.24	4	16.000
20.00	20.00	126	65.0	76.0	0.30	4	20.000

ISO	Hardness	vc	fz (mm/z) / Ø								vc	fz (mm/z) / Ø							
			3	6	8	10	12	16	20	3		6	8	10	12	16	20		
P	≤ 850 N/mm ²	340	0,036	0,072	0,096	0,138	0,17	0,22	0,28	360	0,017	0,034	0,046	0,066	0,08	0,11	0,13		
	≥ 850 N/mm ²	250	0,031	0,062	0,083	0,115	0,14	0,18	0,23	270	0,015	0,030	0,040	0,055	0,07	0,09	0,11		
M	≤ 750 N/mm ²	220	0,031	0,062	0,083	0,115	0,14	0,18	0,23	240	0,015	0,030	0,040	0,055	0,07	0,09	0,11		
	≥ 750 N/mm ²	110	0,024	0,048	0,064	0,092	0,11	0,15	0,18	120	0,011	0,021	0,028	0,040	0,05	0,06	0,08		
S	Ni-based	60	0,019	0,039	0,052	0,074	0,09	0,12	0,15	60	0,008	0,017	0,022	0,032	0,04	0,05	0,06		
	Ti-based	110	0,028	0,055	0,074	0,104	0,12	0,17	0,21	120	0,013	0,026	0,035	0,050	0,06	0,08	0,10		



Standard Ratio end mills RF 100 U

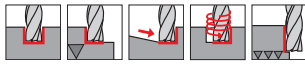
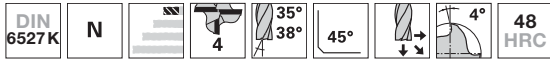

P • **GUHRING NAVIGATOR**
 Cutting data page 328

M
K •
N
S
H ○

- neck clearance
- centre cutting

Tool material	Solid carbide	
Surface	F	F
Type	N	N
Shank form	HA	HB

Steel, cast iron and hardened steel

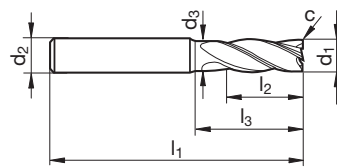

Article no.								6706	3731
d1 h10	d2 h6	d3	l1	l2	l3	c	Z	Code no.	
mm	mm	mm	mm	mm	mm	mm x 45°			
3.00	6.00	2.80	50	5.0	12.0	0.10	4	3.000	
4.00	6.00	3.80	54	8.0	15.0	0.10	4	4.000	
5.00	6.00	4.80	54	9.0	15.0	0.10	4	5.000	
6.00	6.00	5.70	54	10.0	17.0	0.15	4	6.000	
8.00	8.00	7.70	58	12.0	21.0	0.15	4	8.000	
10.00	10.00	9.50	66	14.0	24.0	0.20	4	10.000	
12.00	12.00	11.50	73	16.0	26.0	0.20	4	12.000	
14.00	14.00	13.50	75	18.0	28.0	0.25	4	14.000	
16.00	16.00	15.50	82	22.0	32.0	0.35	4	16.000	
18.00	18.00	17.50	84	24.0	34.0	0.40	4	18.000	
20.00	20.00	19.50	92	26.0	40.0	0.45	4	20.000	

ISO	Hardness	vc	fz (mm/z) / Ø							vc	fz (mm/z) / Ø						
			3	6	8	10	12	16	20		3	6	8	10	12	16	20
P	≤ 850 N/mm ²	180	0,016	0,031	0,042	0,060	0,07	0,10	0,12	305	0,025	0,050	0,067	0,096	0,12	0,15	0,19
	≥ 850 N/mm ²		135	0,014	0,027	0,036	0,050	0,06	0,08		0,10	230	0,022	0,043	0,058	0,080	0,10
K	≤ 240 HB	160	0,017	0,033	0,044	0,065	0,08	0,10	0,13	270	0,026	0,053	0,070	0,104	0,12	0,17	0,21
	≥ 240 HB		140	0,015	0,030	0,040	0,055	0,07	0,09		0,11	240	0,024	0,048	0,064	0,088	0,11

Standard Ratio end mills RF 100 U

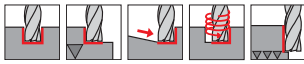

P • **GUHRING NAVIGATOR**

Cutting data page 328

- M**
- K** •
- N**
- S**
- H**

- neck clearance
- centre cutting

Tool material **Solid carbide**

Surface ○

Type **N**

Shank form **HB**

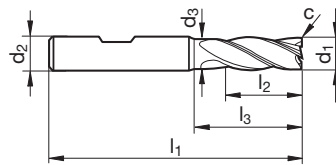

Article no. **3200**

d1 h10	d2 h6	d3	l1	l2	l3	c	Z	Code no.
mm	mm	mm	mm	mm	mm	mm x 45°		
6.00	6.00	5.70	54	10.0	17.0	0.15	4	6.000
8.00	8.00	7.70	58	12.0	21.0	0.15	4	8.000
10.00	10.00	9.50	66	14.0	24.0	0.20	4	10.000
12.00	12.00	11.50	73	16.0	26.0	0.20	4	12.000
14.00	14.00	13.50	75	18.0	28.0	0.25	4	14.000
16.00	16.00	15.50	82	22.0	32.0	0.35	4	16.000
18.00	18.00	17.50	84	24.0	34.0	0.40	4	18.000
20.00	20.00	19.50	92	26.0	40.0	0.45	4	20.000

ISO	Hardness	vc	fz (mm/z) / Ø							vc	fz (mm/z) / Ø						
			3	6	8	10	12	16	20		3	6	8	10	12	16	20
P	≤ 850 N/mm ²	180	0,016	0,031	0,042	0,060	0,07	0,10	0,12	305	0,025	0,050	0,067	0,096	0,12	0,15	0,19
	≥ 850 N/mm ²	135	0,014	0,027	0,036	0,050	0,06	0,08	0,10		230	0,022	0,043	0,058	0,080	0,10	0,13
K	≤ 240 HB	160	0,017	0,033	0,044	0,065	0,08	0,10	0,13	270	0,026	0,053	0,070	0,104	0,12	0,17	0,21
	≥ 240 HB	140	0,015	0,030	0,040	0,055	0,07	0,09	0,11		240	0,024	0,048	0,064	0,088	0,11	0,14

Please reduce cutting values for bright finish tools: vc -50% and fz -25%



Standard Ratio end mills RF 100 U

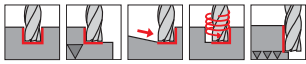

GUHRING NAVIGATOR
Cutting data page 328

P	•
M	
K	•
N	
S	
H	○

- neck clearance
- centre cutting

Tool material	Solid carbide	
Surface	F	F
Type	N	N
Shank form	HA	HB



Steel, cast iron and hardened steel

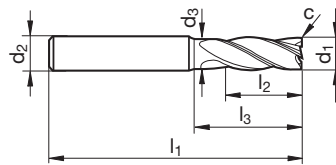

Article no. **3736** **3732**

d1 h10	d2 h6	d3	l1	l2	l3	c	Z	Code no.
mm	mm	mm	mm	mm	mm	mm x 45°		
3.00	6.00	2.80	57	8.0	15.0	0.10	4	3.000
4.00	6.00	3.80	57	11.0	18.0	0.10	4	4.000
5.00	6.00	4.80	57	13.0	18.0	0.10	4	5.000
6.00	6.00	5.70	57	13.0	20.0	0.15	4	6.000
8.00	8.00	7.70	63	19.0	26.0	0.15	4	8.000
10.00	10.00	9.50	72	22.0	30.0	0.20	4	10.000
12.00	12.00	11.50	83	26.0	36.0	0.20	4	12.000
14.00	14.00	13.50	83	26.0	36.0	0.25	4	14.000
16.00	16.00	15.50	92	32.0	42.0	0.35	4	16.000
18.00	18.00	17.50	92	32.0	42.0	0.40	4	18.000
20.00	20.00	19.50	104	38.0	52.0	0.45	4	20.000
25.00	25.00	24.00	121	45.0	63.0	0.60	4	25.000

ISO	Hardness	vc	fz (mm/z) / Ø							vc	fz (mm/z) / Ø						
			3	6	8	10	12	16	20		3	6	8	10	12	16	20
P	≤ 850 N/mm ²	180	0,016	0,031	0,042	0,060	0,07	0,10	0,12	305	0,025	0,050	0,067	0,096	0,12	0,15	0,19
	≥ 850 N/mm ²																
K	≤ 240 HB	160	0,017	0,033	0,044	0,065	0,08	0,10	0,13	270	0,026	0,053	0,070	0,104	0,12	0,17	0,21
	≥ 240 HB																

Standard Ratio end mills RF 100 U

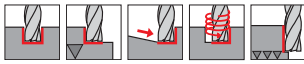

P • **GUHRING NAVIGATOR**

Cutting data page 328

P	•
M	
K	•
N	
S	
H	

- neck clearance
- centre cutting

Tool material **Solid carbide**

Surface	○	○
Type	N	N
Shank form	HA	HB

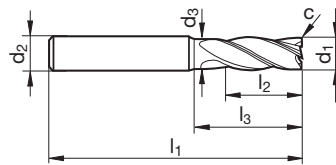

Article no. **3208** **3201**

d1 h10	d2 h6	d3	l1	l2	l3	c	Z	Code no.
mm	mm	mm	mm	mm	mm	mm x 45°		
4.00	6.00	3.80	57	11.0	18.0	0.10	4	4.000
5.00	6.00	4.80	57	13.0	18.0	0.10	4	5.000
6.00	6.00	5.70	57	13.0	20.0	0.15	4	6.000
8.00	8.00	7.70	63	19.0	26.0	0.15	4	8.000
10.00	10.00	9.50	72	22.0	30.0	0.20	4	10.000
12.00	12.00	11.50	83	26.0	36.0	0.20	4	12.000
14.00	14.00	13.50	83	26.0	36.0	0.25	4	14.000
16.00	16.00	15.50	92	32.0	42.0	0.35	4	16.000
18.00	18.00	17.50	92	32.0	42.0	0.40	4	18.000
20.00	20.00	19.50	104	38.0	52.0	0.45	4	20.000
25.00	25.00	24.00	121	45.0	63.0	0.60	4	25.000

ISO	Hardness	vc	fz (mm/z) / Ø							vc	fz (mm/z) / Ø							
			3	6	8	10	12	16	20		3	6	8	10	12	16	20	
P	≤ 850 N/mm ²	180	0,016	0,031	0,042	0,060	0,07	0,10	0,12		305	0,025	0,050	0,067	0,096	0,12	0,15	0,19
	≥ 850 N/mm ²	135	0,014	0,027	0,036	0,050	0,06	0,08	0,10			230	0,022	0,043	0,058	0,080	0,10	0,13
K	≤ 240 HB	160	0,017	0,033	0,044	0,065	0,08	0,10	0,13		270	0,026	0,053	0,070	0,104	0,12	0,17	0,21
	≥ 240 HB	140	0,015	0,030	0,040	0,055	0,07	0,09	0,11			240	0,024	0,048	0,064	0,088	0,11	0,14

Please reduce cutting values for bright finish tools: vc -50% and fz -25%



Standard Ratio end mills RF 100 U

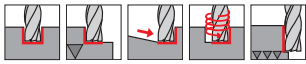
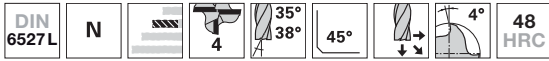

P • **GUHRING NAVIGATOR**

M ○ Cutting data page 328

- K** ○
- N** ○
- S** •
- H** ○

- Raptor® coating
- neck clearance
- centre cutting

Tool material **Solid carbide**

Surface **R**

Type **N**

Shank form **HB**



Steel, cast iron and hardened steel

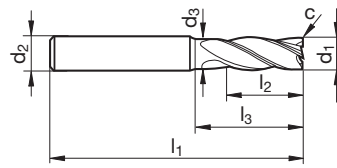

Article no. **6726**

d1 h10	d2 h6	d3	l1	l2	l3	c	Z	Code no.
mm	mm	mm	mm	mm	mm	mm x 45°		
6.00	6.00	5.70	57	13.0	20.0	0.15	4	6.000
8.00	8.00	7.70	63	19.0	26.0	0.15	4	8.000
10.00	10.00	9.50	72	22.0	30.0	0.20	4	10.000
12.00	12.00	11.50	83	26.0	36.0	0.20	4	12.000
16.00	16.00	15.50	92	32.0	42.0	0.35	4	16.000
20.00	20.00	19.50	104	38.0	52.0	0.45	4	20.000

ISO	Hardness	vc	fz (mm/z) / Ø							vc	fz (mm/z) / Ø						
			3	6	8	10	12	16	20		3	6	8	10	12	16	20
P	≤ 850 N/mm ²	340	0,036	0,072	0,096	0,138	0,17	0,22	0,28	360	0,017	0,034	0,046	0,066	0,08	0,11	0,13
	≥ 850 N/mm ²	250	0,031	0,062	0,083	0,115	0,14	0,18	0,23	270	0,015	0,030	0,040	0,055	0,07	0,09	0,11
M	≤ 750 N/mm ²	220	0,031	0,062	0,083	0,115	0,14	0,18	0,23	240	0,015	0,030	0,040	0,055	0,07	0,09	0,11
	≥ 750 N/mm ²	110	0,024	0,048	0,064	0,092	0,11	0,15	0,18	120	0,011	0,021	0,028	0,040	0,05	0,06	0,08
S	Ni-based	60	0,019	0,039	0,052	0,074	0,09	0,12	0,15	60	0,008	0,017	0,022	0,032	0,04	0,05	0,06
	Ti-based	110	0,028	0,055	0,074	0,104	0,12	0,17	0,21	120	0,013	0,026	0,035	0,050	0,06	0,08	0,10

Standard Ratio end mills RF 100 U

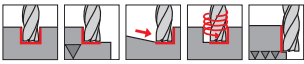

P	•
M	
K	•
N	
S	
H	○

GUHRING NAVIGATOR

Cutting data page 328

- neck clearance
- centre cutting

Tool material	Solid carbide	
Surface	F	F
Type	N	N
Shank form	HA	HB

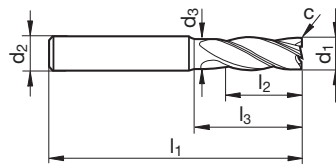

Article no. **3837** **3838**

d1 h10	d2 h6	d3	l1	l2	l3	c	Z	Code no.
mm	mm	mm	mm	mm	mm	mm x 45°		
6.00	6.00	5.70	65	13.0	28.0	0.15	4	6.000
8.00	8.00	7.70	75	19.0	38.0	0.15	4	8.000
10.00	10.00	9.50	80	22.0	38.0	0.20	4	10.000
12.00	12.00	11.50	93	26.0	46.0	0.20	4	12.000
16.00	16.00	15.50	108	32.0	58.0	0.35	4	16.000
20.00	20.00	19.50	126	38.0	74.0	0.45	4	20.000

ISO	Hardness	vc	fz (mm/z) / Ø							vc	fz (mm/z) / Ø						
			3	6	8	10	12	16	20		3	6	8	10	12	16	20
P	≤ 850 N/mm ²	110	0,009	0,019	0,025	0,036	0,04	0,06	0,07	145	0,013	0,025	0,033	0,048	0,06	0,08	0,10
	≥ 850 N/mm ²	80	0,008	0,016	0,022	0,030	0,04	0,05	0,06	110	0,011	0,022	0,029	0,040	0,05	0,06	0,08
K	≤ 240 HB	95	0,010	0,020	0,026	0,039	0,05	0,06	0,08	135	0,013	0,027	0,035	0,052	0,06	0,08	0,10
	≥ 240 HB	85	0,009	0,018	0,024	0,033	0,04	0,05	0,07	120	0,012	0,024	0,032	0,044	0,05	0,07	0,09



Standard Ratio end mills RF 100 U

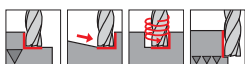

P • **GUHRING NAVIGATOR**
M Cutting data page 328
K •
N
S
H ○

- neck clearance
- centre cutting

Tool material	Solid carbide	
Surface	F	F
Type	N	N
Shank form	HA	HB



Steel, cast iron and hardened steel

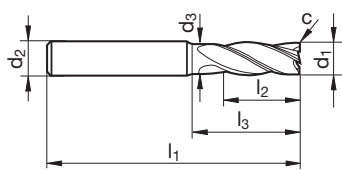

Article no. **3839** **3871**

d1 h10	d2 h6	d3	l1	l2	l3	c	Z	Code no.
mm	mm	mm	mm	mm	mm	mm x 45°		
6.00	6.00	5.70	65	18.0	28.0	0.15	4	6.000
8.00	8.00	7.70	75	24.0	38.0	0.15	4	8.000
10.00	10.00	9.50	80	30.0	38.0	0.20	4	10.000
12.00	12.00	11.50	93	36.0	46.0	0.20	4	12.000
16.00	16.00	15.50	108	48.0	58.0	0.35	4	16.000
20.00	20.00	19.50	126	60.0	74.0	0.45	4	20.000

ISO	Hardness	vc	fz (mm/z) / Ø							vc	fz (mm/z) / Ø						
			3	6	8	10	12	16	20		3	6	8	10	12	16	20
P	≤ 850 N/mm ²	340	0,036	0,072	0,096	0,138	0,17	0,22	0,28	360	0,017	0,034	0,046	0,066	0,08	0,11	0,13
	≥ 850 N/mm ²	250	0,031	0,062	0,083	0,115	0,14	0,18	0,23	270	0,015	0,030	0,040	0,055	0,07	0,09	0,11
K	≤ 240 HB	300	0,038	0,076	0,101	0,150	0,18	0,24	0,30	320	0,018	0,036	0,048	0,072	0,09	0,11	0,14
	≥ 240 HB	260	0,035	0,069	0,092	0,127	0,15	0,20	0,25	280	0,017	0,033	0,044	0,061	0,07	0,10	0,12

Standard Ratio end mills RF 100 U



P • **GUHRING NAVIGATOR**

Cutting data page 328

- M**
- K** •
- N**
- S**
- H**

- neck clearance
- centre cutting

Tool material	Solid carbide	
Surface	○	Ⓡ
Type	N	N
Shank form	HA	HA

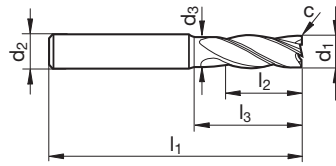

Article no. **3209** **3627**

d1 h10	d2 h6	d3	l1	l2	l3	c	Z	Code no.
mm	mm	mm	mm	mm	mm	mm x 45°		
10.00	10.00	9.50	100	40.0	48.0	0.20	4	10.000
12.00	12.00	11.50	150	45.0	58.0	0.20	4	12.000
14.00	14.00	13.50	150	45.0	58.0	0.25	4	14.000
16.00	16.00	15.50	150	65.0	78.0	0.35	4	16.000
18.00	18.00	17.50	150	65.0	78.0	0.40	4	18.000
20.00	20.00	19.50	150	65.0	78.0	0.45	4	20.000
25.00	25.00	24.00	150	75.0	92.0	0.60	4	25.000

ISO	Hardness	vc	fz (mm/z) / Ø							vc	fz (mm/z) / Ø						
			3	6	8	10	12	16	20		3	6	8	10	12	16	20
P	≤ 850 N/mm ²	130	0,013	0,025	0,012	0,048	0,06	0,08	0,10	160	0,009	0,017	0,023	0,033	0,04	0,05	0,07
	≥ 850 N/mm ²	100	0,011	0,022	0,029	0,040	0,05	0,06	0,08	120	0,007	0,015	0,020	0,028	0,03	0,04	0,06
K	≤ 240 HB	120	0,013	0,027	0,035	0,052	0,06	0,08	0,10	140	0,009	0,018	0,024	0,036	0,04	0,06	0,07
	≥ 240 HB	100	0,012	0,024	0,032	0,044	0,05	0,07	0,09	120	0,008	0,017	0,022	0,030	0,04	0,05	0,06

Please reduce cutting values for bright finish tools: vc -50% and fz -25%



Standard Ratio end mills RF 100 U

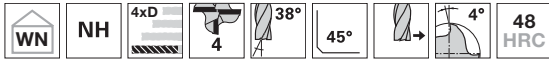

P • **GUHRING NAVIGATOR**
 Cutting data page 328

M

K •

N

S

H ○

- neck clearance
- centre cutting

Tool material	Solid carbide	
Surface	F	F
Type	NH	NH
Shank form	HA	HB



Steel, cast iron and hardened steel

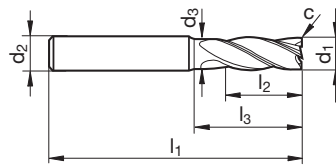

Article no. **6767** **6768**

d1 h10	d2 h6	d3	l1	l2	l3	c	Z	Code no.
mm	mm	mm	mm	mm	mm	mm x 45°		
6.00	6.00	5.70	65	24.0	28.0	0.12	4	6.000
8.00	8.00	7.70	75	32.0	38.0	0.16	4	8.000
10.00	10.00	9.50	100	40.0	58.0	0.20	4	10.000
12.00	12.00	11.50	100	48.0	53.0	0.24	4	12.000
16.00	16.00	15.50	125	64.0	75.0	0.32	4	16.000
20.00	20.00	19.50	150	80.0	98.0	0.40	4	20.000
25.00	25.00	24.00	175	100.0	117.0	0.50	4	25.000

ISO	Hardness	vc	fz (mm/z) / Ø								vc	fz (mm/z) / Ø								
			3	6	8	10	12	16	20	3		6	8	10	12	16	20			
P	≤ 850 N/mm ²	130	0,013	0,025	0,012	0,048	0,06	0,08	0,10	HPC	HSC	ae max. = 0,10 x D	160	0,009	0,017	0,023	0,033	0,04	0,05	0,07
	≥ 850 N/mm ²	100	0,011	0,022	0,029	0,040	0,05	0,06	0,08				120	0,007	0,015	0,020	0,028	0,03	0,04	0,06
K	≤ 240 HB	120	0,013	0,027	0,035	0,052	0,06	0,08	0,10	HPC	HSC	ae max. = 0,02 x D	140	0,009	0,018	0,024	0,036	0,04	0,06	0,07
	≥ 240 HB	100	0,012	0,024	0,032	0,044	0,05	0,07	0,09				120	0,008	0,017	0,022	0,030	0,04	0,05	0,06

Standard Ratio end mills RF 100 U

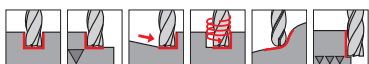

P	•
M	
K	•
N	
S	
H	○

GUHRING NAVIGATOR

Cutting data page 328

- re-inforced core
- neck clearance
- centre cutting

Tool material **Solid carbide**

Surface **F** **F**

Type **N** **N**

Shank form **HA** **HB**

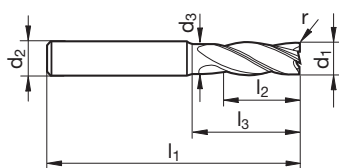

Article no. **3872** **3873**

d1 h10	d2 h6	d3	l1	l2	l3	r	Z	Code no.
mm	mm	mm	mm	mm	mm	mm		
6.00	6.00	5.70	57	13.0	20.0	0.5	4	6.005
6.00	6.00	5.70	57	13.0	20.0	1.0	4	6.010
6.00	6.00	5.70	57	13.0	20.0	2.0	4	6.020
8.00	8.00	7.70	63	19.0	26.0	0.5	4	8.005
8.00	8.00	7.70	63	19.0	26.0	1.0	4	8.010
8.00	8.00	7.70	63	19.0	26.0	2.0	4	8.020
10.00	10.00	9.50	72	22.0	30.0	0.5	4	10.005
10.00	10.00	9.50	72	22.0	30.0	1.0	4	10.010
10.00	10.00	9.50	72	22.0	30.0	2.0	4	10.020
12.00	12.00	11.50	83	26.0	36.0	0.5	4	12.005
12.00	12.00	11.50	83	26.0	36.0	1.0	4	12.010
12.00	12.00	11.50	83	26.0	36.0	2.0	4	12.020
16.00	16.00	15.50	92	32.0	42.0	0.5	4	16.005
16.00	16.00	15.50	92	32.0	42.0	1.0	4	16.010
16.00	16.00	15.50	92	32.0	42.0	2.0	4	16.020
16.00	16.00	15.50	92	32.0	42.0	3.0	4	16.030
20.00	20.00	19.50	104	38.0	52.0	0.5	4	20.005
20.00	20.00	19.50	104	38.0	52.0	1.0	4	20.010
20.00	20.00	19.50	104	38.0	52.0	2.0	4	20.020
20.00	20.00	19.50	104	38.0	52.0	3.0	4	20.030
25.00	25.00	24.00	121	45.0	63.0	2.0	4	25.020
25.00	25.00	24.00	121	45.0	63.0	3.0	4	25.030

ISO	Hardness	vc	fz (mm/z) / Ø							vc	fz (mm/z) / Ø						
			3	6	8	10	12	16	20		3	6	8	10	12	16	20
P	≤ 850 N/mm ²	180	0,016	0,031	0,042	0,060	0,07	0,10	0,12	305	0,025	0,050	0,067	0,096	0,12	0,15	0,19
	≥ 850 N/mm ²	135	0,014	0,027	0,036	0,050	0,06	0,08	0,10	230	0,022	0,043	0,058	0,080	0,10	0,13	0,16
K	≤ 240 HB	160	0,017	0,033	0,044	0,065	0,08	0,10	0,13	270	0,026	0,053	0,070	0,104	0,12	0,17	0,21
	≥ 240 HB	140	0,015	0,030	0,040	0,055	0,07	0,09	0,11	240	0,024	0,048	0,064	0,088	0,11	0,14	0,18

RF 100 U/HF - High performance roughing end mills for steel and cast materials

Ratio®



more stable asymmetrical roughing geometry produce smooth surface finishes



larger flutes for optimal chip evacuation



roughing geometry reduces cutting pressure in comparison to smooth cutting milling cutters

innovative roughing geometry
produces smaller chips

RF 100 VA NF
Art. no. 6877



RF 100 U HF
Art. no. 6881



RF 100 A WF
Art. no. 6868

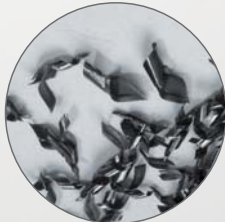
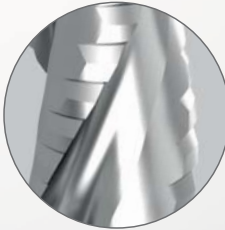

Standard Ratio end mills RF 100 U

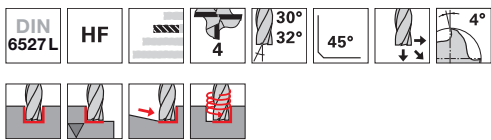

P	•
M	
K	•
N	
S	
H	

GUHRING NAVIGATOR

Cutting data page 329

- neck clearance
- centre cutting

Tool material **Solid carbide**

Surface	F	F
Type	HF	HF
Shank form	HA	HB
	NEW	NEW

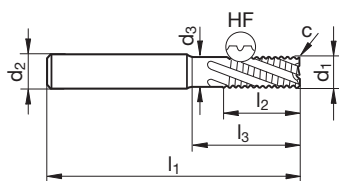

Article no. **6881** **6882**

d1 h10	d2 h6	d3	l1	l2	l3	c	Z	Code no.
mm	mm	mm	mm	mm	mm	mm x 45°		
6.00	6.00	5.70	57	13.0	20.0	0.12	4	6.000
8.00	8.00	7.70	63	19.0	26.0	0.16	4	8.000
10.00	10.00	9.50	72	22.0	30.0	0.20	4	10.000
12.00	12.00	11.50	83	26.0	36.0	0.24	4	12.000
16.00	16.00	15.50	92	32.0	42.0	0.32	4	16.000
20.00	20.00	19.50	104	38.0	52.0	0.40	4	20.000
25.00	25.00	24.00	121	45.0	63.0	0.50	4	25.000

ISO	Hardness	vc	fz (mm/z) / Ø							vc	fz (mm/z) / Ø							
			3	6	8	10	12	16	20		3	6	8	10	12	16	20	
P	≤ 850 N/mm ²	135	0,009	0,018	0,024	0,032	0,038	0,051	0,064		160	0,010	0,021	0,028	0,037	0,044	0,059	0,074
	≥ 850 N/mm ²	100	0,008	0,017	0,022	0,030	0,036	0,048	0,060			120	0,010	0,019	0,026	0,035	0,041	0,055
K	≤ 240 HB	120	0,009	0,018	0,024	0,032	0,038	0,051	0,064		140	0,010	0,021	0,028	0,037	0,044	0,059	0,074
	≥ 240 HB	105	0,008	0,017	0,022	0,030	0,036	0,048	0,060			130	0,010	0,019	0,026	0,035	0,041	0,055



Standard Ratio end mills RF 100 U

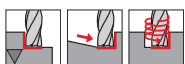

P • **GUHRING NAVIGATOR**
Cutting data page 329

M

K •

N

S

H • neck clearance
• centre cutting

Tool material	Solid carbide	
Surface	F	F
Type	HF	HF
Shank form	HA	HB
	NEW	NEW

Steel, cast iron and hardened steel

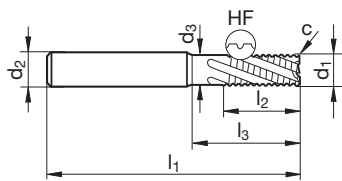

Article no. **6883** **6884**

d1 h10	d2 h6	d3	l1	l2	l3	c	Z	Code no.
mm	mm	mm	mm	mm	mm	mm x 45°		
6.00	6.00	5.70	65	18.0	28.0	0.12	4	6.000
8.00	8.00	7.70	75	24.0	38.0	0.16	4	8.000
10.00	10.00	9.50	80	30.0	38.0	0.20	4	10.000
12.00	12.00	11.50	93	36.0	46.0	0.24	4	12.000
16.00	16.00	15.50	108	48.0	58.0	0.32	4	16.000
20.00	20.00	19.50	126	60.0	74.0	0.40	4	20.000

ISO	Hardness	vc	fz (mm/z) / Ø							vc	fz (mm/z) / Ø						
			3	6	8	10	12	16	20		3	6	8	10	12	16	20
P	≤ 850 N/mm ²	80	ap = 1,0 x D							140	ap = 3,0 x D						
	≥ 850 N/mm ²		0,005	0,011	0,014	0,019	0,023	0,031	0,038		0,008	0,016	0,022	0,029	0,035	0,047	0,058
K	≤ 240 HB	70	ap = 1,0 x D							105	ap = 3,0 x D						
	≥ 240 HB		0,005	0,010	0,013	0,018	0,022	0,029	0,036		0,008	0,015	0,020	0,027	0,033	0,044	0,055
K	≤ 240 HB	65	ap = 1,0 x D							125	ap = 3,0 x D						
	≥ 240 HB		0,005	0,010	0,013	0,018	0,022	0,029	0,036		0,008	0,015	0,020	0,027	0,033	0,044	0,055

Standard Ratio end mills RF 100 U

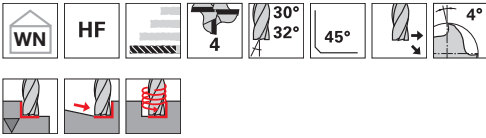

P	•
M	
K	•
N	
S	
H	

GUHRING NAVIGATOR

Cutting data page 329

- neck clearance
- centre cutting

Tool material	Solid carbide	
Surface	F	F
Type	HF	HF
Shank form	HA	HB

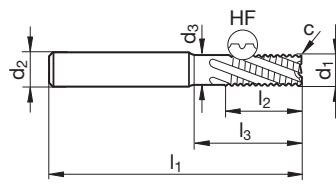

Article no. **6885** **6886**

d1 h10	d2 h6	d3	l1	l2	l3	c	Z	Code no.
mm	mm	mm	mm	mm	mm	mm x 45°		
6.00	6.00	5.70	75	13.0	34.0	0.12	4	6.000
8.00	8.00	7.70	100	19.0	49.0	0.16	4	8.000
10.00	10.00	9.50	100	22.0	48.0	0.20	4	10.000
12.00	12.00	11.50	150	26.0	58.0	0.24	4	12.000
16.00	16.00	15.50	150	32.0	78.0	0.32	4	16.000
20.00	20.00	19.50	150	38.0	78.0	0.40	4	20.000

ISO	Hardness	vc	fz (mm/z) / Ø							vc	fz (mm/z) / Ø						
			3	6	8	10	12	16	20		3	6	8	10	12	16	20
P	≤ 850 N/mm ²	55	0,003	0,006	0,008	0,011	0,013	0,018	0,022	80	0,004	0,008	0,011	0,015	0,017	0,023	0,029
	≥ 850 N/mm ²	40	0,003	0,006	0,008	0,011	0,013	0,017	0,021	60	0,004	0,008	0,010	0,014	0,016	0,022	0,027
K	≤ 240 HB	50	0,003	0,006	0,008	0,011	0,013	0,018	0,022	70	0,004	0,008	0,011	0,015	0,017	0,023	0,029
	≥ 240 HB	40	0,003	0,006	0,008	0,011	0,013	0,017	0,021	65	0,004	0,008	0,010	0,014	0,016	0,022	0,027



High-performance roughing end mills RS 100 U

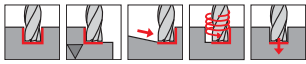

GUHRING NAVIGATOR
Cutting data page 329

P	•
M	•
K	•
N	○
S	•
H	

- neck clearance
- centre cutting

Tool material	Solid carbide	
Surface	F	F
Type	NF	NF
Shank form	HA	HB
	NEW	NEW

Steel, cast iron and hardened steel

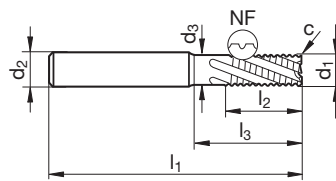

Article no. 6887 6888

d1 h10	d2 h6	d3	l1	l2	l3	c	Z	Code no.
mm	mm	mm	mm	mm	mm	mm x 45°		
6.00	6.00	5.70	57	13.0	20.0	0.12	4	6.000
8.00	8.00	7.70	63	19.0	26.0	0.16	4	8.000
10.00	10.00	9.50	72	22.0	30.0	0.20	4	10.000
12.00	12.00	11.50	83	26.0	36.0	0.24	4	12.000
14.00	14.00	13.50	83	26.0	36.0	0.28	4	14.000
16.00	16.00	15.50	92	32.0	42.0	0.32	4	16.000
18.00	18.00	17.50	92	32.0	42.0	0.36	4	18.000
20.00	20.00	19.50	104	38.0	52.0	0.40	4	20.000
25.00	25.00	24.00	121	45.0	63.0	0.60	5	25.000

ISO	Hardness	vc	fz (mm/z) / Ø							vc	fz (mm/z) / Ø						
			3	6	8	10	12	16	20		3	6	8	10	12	16	20
P	≤ 850 N/mm ²	135	0,009	0,018	0,024	0,032	0,038	0,051	0,064	160	0,010	0,021	0,028	0,037	0,044	0,059	0,074
	≥ 850 N/mm ²	100	0,008	0,017	0,022	0,030	0,036	0,048	0,060		120	0,010	0,019	0,026	0,035	0,041	0,055
M	≤ 750 N/mm ²	90	0,008	0,017	0,022	0,030	0,036	0,048	0,060	110	0,010	0,019	0,026	0,035	0,041	0,055	0,069
	≥ 750 N/mm ²	55	0,007	0,013	0,018	0,025	0,030	0,040	0,050		70	0,008	0,016	0,021	0,030	0,036	0,048
S	Ni-based	25	0,006	0,012	0,016	0,022	0,026	0,035	0,044	40	0,007	0,014	0,019	0,026	0,032	0,042	0,053
	Ti-based	50	0,007	0,013	0,018	0,025	0,030	0,040	0,050		70	0,008	0,016	0,021	0,030	0,036	0,048
K	≤ 240 HB	120	0,009	0,018	0,024	0,032	0,038	0,051	0,064	140	0,010	0,021	0,028	0,037	0,044	0,059	0,074
	≥ 240 HB	105	0,008	0,017	0,022	0,030	0,036	0,048	0,060		130	0,010	0,019	0,026	0,035	0,041	0,055

High-performance roughing end mills RS 100 F

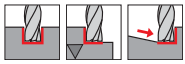

P	•
M	
K	•
N	
S	
H	○

GUHRING NAVIGATOR

Cutting data page 329

- neck clearance
- centre cutting

Tool material **Solid carbide**

Surface	F	F
Type	NF	NF
Shank form	HA	HB
	NEW	NEW

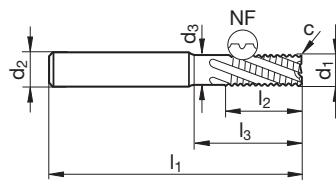

Article no. **6889** **6890**

d1 h10	d2 h6	d3	l1	l2	l3	c	Z	Code no.
mm	mm	mm	mm	mm	mm	mm x 45°		
6.00	6.00	5.70	57	13.0	20.0	0.30	5	6.000
8.00	8.00	7.70	63	19.0	26.0	0.30	5	8.000
10.00	10.00	9.50	72	22.0	30.0	0.30	5	10.000
12.00	12.00	11.50	83	26.0	36.0	0.50	5	12.000
16.00	16.00	15.50	92	32.0	42.0	0.50	6	16.000
20.00	20.00	19.50	104	38.0	52.0	0.50	6	20.000
25.00	25.00	24.00	121	45.0	63.0	0.60	6	25.000

ISO	Hardness	vc	fz (mm/z) / Ø							vc	fz (mm/z) / Ø							
			3	6	8	10	12	16	20		3	6	8	10	12	16	20	
P	≤ 850 N/mm ²	135	0,009	0,018	0,024	0,032	0,038	0,051	0,064		160	0,010	0,021	0,028	0,037	0,044	0,059	0,074
	≥ 850 N/mm ²	100	0,008	0,017	0,022	0,030	0,036	0,048	0,060			120	0,010	0,019	0,026	0,035	0,041	0,055
K	≤ 240 HB	120	0,009	0,018	0,024	0,032	0,038	0,051	0,064		140	0,010	0,021	0,028	0,037	0,044	0,059	0,074
	≥ 240 HB	105	0,008	0,017	0,022	0,030	0,036	0,048	0,060			130	0,010	0,019	0,026	0,035	0,041	0,055



Roughing end mills GS 100 U (fine teeth)

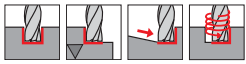

P • **GUHRING NAVIGATOR**
M • Cutting data page 331
K •
N ○
S ○
H ○
 • centre cutting

Tool material	Solid carbide	
Surface	○	Ⓡ
Type	NRf	NRf
Shank form	HB	HB

Steel, cast iron and hardened steel

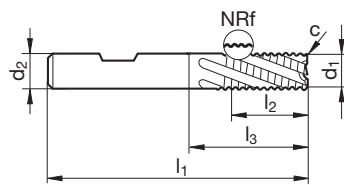

Article no. **3204** **3723**

d1 h10	d2 h6	l1	l2	l3	c	Z	Code no.
mm	mm	mm	mm	mm	mm x 45°		
6.00	6.00	57	13.0	21.0	0.30	4	6.000
8.00	8.00	63	19.0	27.0	0.30	4	8.000
10.00	10.00	72	22.0	32.0	0.30	4	10.000
12.00	12.00	83	26.0	38.0	0.50	4	12.000
14.00	14.00	83	26.0	38.0	0.50	4	14.000
14.00	16.00	92	32.0	42.0	0.50	4	14.001
16.00	16.00	92	32.0	44.0	0.50	4	16.000
18.00	18.00	92	32.0	44.0	0.50	4	18.000
18.00	20.00	104	38.0	53.0	0.50	4	18.001
18.00	20.00	104	38.0	50.0	0.50	4	18.001
20.00	20.00	104	38.0	54.0	0.50	4	20.000
25.00	25.00	121	45.0	65.0	0.60	5	25.000

ISO	Hardness	vc	fz (mm/z) / Ø							vc	fz (mm/z) / Ø							
			3	6	8	10	12	16	20		3	6	8	10	12	16	20	
P	≤ 850 N/mm ²	120	0,008	0,017	0,022	0,030	0,036	0,048	0,060		140	0,010	0,019	0,026	0,035	0,041	0,055	0,069
	≥ 850 N/mm ²	90	0,008	0,015	0,020	0,028	0,034	0,045	0,056			110	0,009	0,017	0,023	0,032	0,039	0,052
M	≤ 750 N/mm ²	80	0,008	0,015	0,020	0,028	0,034	0,045	0,056		100	0,009	0,017	0,023	0,032	0,039	0,052	0,064
	≥ 750 N/mm ²	50	0,006	0,012	0,016	0,022	0,026	0,035	0,044			70	0,007	0,014	0,019	0,026	0,032	0,042
S	Ni-based	20	0,005	0,011	0,014	0,020	0,024	0,032	0,040		30	0,006	0,013	0,017	0,024	0,029	0,038	0,048
	Ti-based	45	0,006	0,012	0,016	0,022	0,026	0,035	0,044			60	0,007	0,014	0,019	0,026	0,032	0,042
K	≤ 240 HB	100	0,008	0,017	0,022	0,030	0,036	0,048	0,060		120	0,010	0,019	0,026	0,035	0,041	0,055	0,069
	≥ 240 HB	90	0,008	0,015	0,020	0,028	0,034	0,045	0,056			110	0,009	0,017	0,023	0,032	0,039	0,052

Please reduce cutting values for bright finish tools: vc -50% and fz -25%

Roughing end mills GS 100 U (fine teeth)

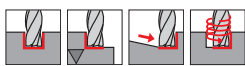

P • **GUHRING NAVIGATOR**

M • Cutting data page 331

K •

N ○

S ○

- H**
 - with internal coolant supply
 - centre cutting

Tool material **Solid carbide**

Surface **F**

Type **NRf**

Shank form **HB**

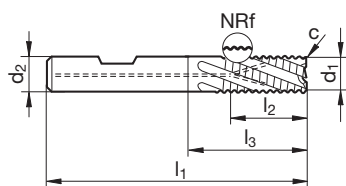

Article no. **3365**

d1 h10	d2 h6	l1	l2	l3	c	Z	Code no.
mm	mm	mm	mm	mm	mm x 45°		
6.00	6.00	57	13.0	21.0	0.30	4	6.000
8.00	8.00	63	19.0	27.0	0.30	4	8.000
10.00	10.00	72	22.0	32.0	0.30	4	10.000
12.00	12.00	83	26.0	38.0	0.50	4	12.000
16.00	16.00	92	32.0	44.0	0.50	4	16.000
20.00	20.00	104	38.0	54.0	0.50	4	20.000

ISO	Hardness	vc	fz (mm/z) / Ø							vc	fz (mm/z) / Ø						
			3	6	8	10	12	16	20		3	6	8	10	12	16	20
P	≤ 850 N/mm ²	120	0,008	0,017	0,022	0,030	0,036	0,048	0,060	140	0,010	0,019	0,026	0,035	0,041	0,055	0,069
	≥ 850 N/mm ²	90	0,008	0,015	0,020	0,028	0,034	0,045	0,056		110	0,009	0,017	0,023	0,032	0,039	0,052
M	≤ 750 N/mm ²	80	0,008	0,015	0,020	0,028	0,034	0,045	0,056	100	0,009	0,017	0,023	0,032	0,039	0,052	0,064
	≥ 750 N/mm ²	50	0,006	0,012	0,016	0,022	0,026	0,035	0,044		70	0,007	0,014	0,019	0,026	0,032	0,042
S	Ni-based	20	0,005	0,011	0,014	0,020	0,024	0,032	0,040	30	0,006	0,013	0,017	0,024	0,029	0,038	0,048
	Ti-based	45	0,006	0,012	0,016	0,022	0,026	0,035	0,044		60	0,007	0,014	0,019	0,026	0,032	0,042
K	≤ 240 HB	100	0,008	0,017	0,022	0,030	0,036	0,048	0,060	120	0,010	0,019	0,026	0,035	0,041	0,055	0,069
	≥ 240 HB	90	0,008	0,015	0,020	0,028	0,034	0,045	0,056		110	0,009	0,017	0,023	0,032	0,039	0,052

RF 100 SF – high-performance semi-roughing milling cutter for materials up to 1600 N/mm² (48 HRC)

Ratio®



optimal smooth running
thanks to Ratio effect with different
helix angles:
44°/45°/46° for fine finishing
and HPC roughing

*i*machining®

highest surface finish quality
thanks to stable radial geometry

perfect stability
with neck clearance
and optimised transition angles

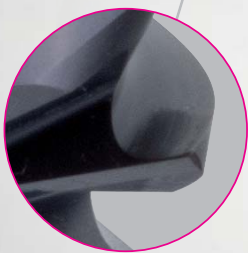

micro-corner protection
for longer tool life

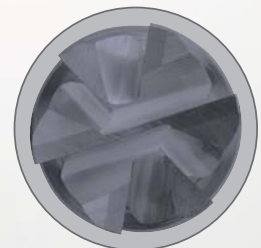

Stable face cutting edges
with micro-corner protection
from corner chamfers and
face cutting edge protection
for long tool life
and optimised surface finish.

Ratio end mills Superfinish RF 100 SF

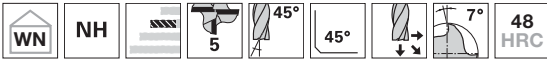

P • **GUHRING NAVIGATOR**

M • Cutting data page 328

K •

N •

S •

H ○ • neck clearance
• centre cutting

Tool material	Solid carbide	
Surface	F	F
Type	NH	NH
Shank form	HA	HB

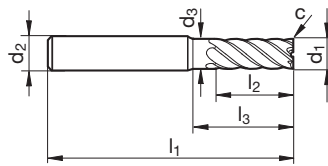

Article no. **6709** **6710**

d1 h10	d2 h6	d3	l1	l2	l3	c	Z	Code no.
mm	mm	mm	mm	mm	mm	mm x 45°		
4.00	6.00	3.80	57	11.0	18.0	0.05	5	4.000
5.00	6.00	4.80	57	13.0	18.0	0.05	5	5.000
6.00	6.00	5.70	57	13.0	20.0	0.05	5	6.000
8.00	8.00	7.70	63	19.0	26.0	0.10	5	8.000
10.00	10.00	9.50	72	22.0	30.0	0.10	5	10.000
12.00	12.00	11.50	83	26.0	36.0	0.10	5	12.000
16.00	16.00	15.50	92	32.0	42.0	0.15	5	16.000
20.00	20.00	19.50	104	38.0	52.0	0.15	5	20.000
25.00	25.00	24.00	121	45.0	63.0	0.20	5	25.000

ISO	Hardness	vc	fz (mm/z) / Ø								vc	fz (mm/z) / Ø							
			3	6	8	10	12	16	20	3		6	8	10	12	16	20		
P	≤ 850 N/mm ²	340	0,036	0,072	0,096	0,138	0,17	0,22	0,28	360	0,017	0,034	0,046	0,066	0,08	0,11	0,13		
	≥ 850 N/mm ²	250	0,031	0,062	0,083	0,115	0,14	0,18	0,23	270	0,015	0,030	0,040	0,055	0,07	0,09	0,11		
M	≤ 750 N/mm ²	220	0,031	0,062	0,083	0,115	0,14	0,18	0,23	240	0,015	0,030	0,040	0,055	0,07	0,09	0,11		
	≥ 750 N/mm ²	110	0,024	0,048	0,064	0,092	0,11	0,15	0,18	120	0,011	0,021	0,028	0,040	0,05	0,06	0,08		
S	Ni-based	60	0,019	0,039	0,052	0,074	0,09	0,12	0,15	60	0,008	0,017	0,022	0,032	0,04	0,05	0,06		
	Ti-based	110	0,028	0,055	0,074	0,104	0,12	0,17	0,21	120	0,013	0,026	0,035	0,050	0,06	0,08	0,10		
K	≤ 240 HB	300	0,038	0,076	0,101	0,150	0,18	0,24	0,30	320	0,018	0,036	0,048	0,072	0,09	0,11	0,14		
	≥ 240 HB	260	0,035	0,069	0,092	0,127	0,15	0,20	0,25	280	0,017	0,033	0,044	0,061	0,07	0,10	0,12		
N	≤ 7 % Si	900	0,045	0,090	0,120	0,184	0,22	0,29	0,37	1000	0,021	0,043	0,057	0,088	0,11	0,14	0,18		
	≥ 7 % Si	430	0,038	0,076	0,101	0,138	0,17	0,22	0,28	460	0,018	0,036	0,048	0,066	0,08	0,11	0,13		



Ratio end mills Superfinish RF 100 SF

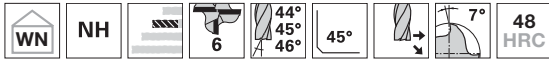

P • **GUHRING NAVIGATOR**
M • Cutting data page 328
K •
N •
S •
H ○ • neck clearance
 • centre cutting

Tool material	Solid carbide	
Surface	F	F
Type	NH	NH
Shank form	HA	HB



Steel, cast iron and hardened steel

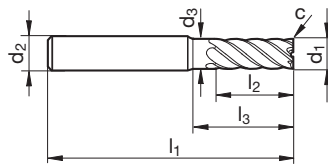

Article no. **3631** **3632**

d1 h10	d2 h6	d3	l1	l2	l3	c	Z	Code no.
mm	mm	mm	mm	mm	mm	mm x 45°		
8.00	8.00	7.70	63	19.0	26.0	0.10	6	8.000
10.00	10.00	9.50	72	22.0	30.0	0.10	6	10.000
12.00	12.00	11.50	83	26.0	36.0	0.10	6	12.000
16.00	16.00	15.50	92	32.0	42.0	0.15	6	16.000
20.00	20.00	19.50	104	38.0	52.0	0.15	6	20.000
25.00	25.00	24.00	121	45.0	63.0	0.20	6	25.000

ISO	Hardness	vc	fz (mm/z) / Ø							vc	fz (mm/z) / Ø						
			3	6	8	10	12	16	20		3	6	8	10	12	16	20
P	≤ 850 N/mm ²	340	0,036	0,072	0,096	0,138	0,17	0,22	0,28	360	0,017	0,034	0,046	0,066	0,08	0,11	0,13
	≥ 850 N/mm ²	250	0,031	0,062	0,083	0,115	0,14	0,18	0,23	270	0,015	0,030	0,040	0,055	0,07	0,09	0,11
M	≤ 750 N/mm ²	220	0,031	0,062	0,083	0,115	0,14	0,18	0,23	240	0,015	0,030	0,040	0,055	0,07	0,09	0,11
	≥ 750 N/mm ²	110	0,024	0,048	0,064	0,092	0,11	0,15	0,18	120	0,011	0,021	0,028	0,040	0,05	0,06	0,08
S	Ni-based	60	0,019	0,039	0,052	0,074	0,09	0,12	0,15	60	0,008	0,017	0,022	0,032	0,04	0,05	0,06
	Ti-based	110	0,028	0,055	0,074	0,104	0,12	0,17	0,21	120	0,013	0,026	0,035	0,050	0,06	0,08	0,10
K	≤ 240 HB	300	0,038	0,076	0,101	0,150	0,18	0,24	0,30	320	0,018	0,036	0,048	0,072	0,09	0,11	0,14
	≥ 240 HB	260	0,035	0,069	0,092	0,127	0,15	0,20	0,25	280	0,017	0,033	0,044	0,061	0,07	0,10	0,12
N	≤ 7 % Si	900	0,045	0,090	0,120	0,184	0,22	0,29	0,37	1000	0,021	0,043	0,057	0,088	0,11	0,14	0,18
	≥ 7 % Si	430	0,038	0,076	0,101	0,138	0,17	0,22	0,28	460	0,018	0,036	0,048	0,066	0,08	0,11	0,13

Ratio end mills Superfinish RF 100 SF

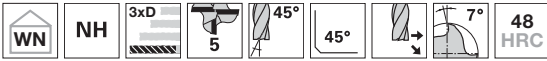

P • **GUHRING NAVIGATOR**

M • Cutting data page 328

K •

N •

S •

H ○ • neck clearance
• centre cutting

Tool material	Solid carbide	
Surface	F	F
Type	NH	NH
Shank form	HA	HB

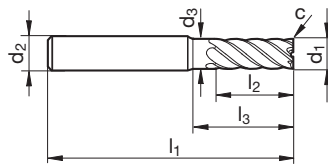

Article no. **3897** **3898**

d1 h10	d2 h6	d3	l1	l2	l3	c	Z	Code no.
mm	mm	mm	mm	mm	mm	mm x 45°		
4.00	6.00	3.80	65	12.0	26.0	0.05	5	4.000
5.00	6.00	4.80	65	15.0	26.0	0.05	5	5.000
6.00	6.00	5.70	65	18.0	28.0	0.05	5	6.000
8.00	8.00	7.70	75	24.0	38.0	0.10	5	8.000
10.00	10.00	9.50	80	30.0	38.0	0.10	5	10.000
12.00	12.00	11.50	93	36.0	46.0	0.10	5	12.000
16.00	16.00	15.50	108	48.0	58.0	0.15	5	16.000
20.00	20.00	19.50	126	60.0	74.0	0.15	5	20.000

ISO	Hardness	vc	fz (mm/z) / Ø								vc	fz (mm/z) / Ø									
			3	6	8	10	12	16	20	3		6	8	10	12	16	20				
P	≤ 850 N/mm ²	340	0,036	0,072	0,096	0,138	0,17	0,22	0,28				ae max. = 0,10 x D	360	0,017	0,034	0,046	0,066	0,08	0,11	0,13
	≥ 850 N/mm ²	250	0,031	0,062	0,083	0,115	0,14	0,18	0,23					270	0,015	0,030	0,040	0,055	0,07	0,09	0,11
M	≤ 750 N/mm ²	220	0,031	0,062	0,083	0,115	0,14	0,18	0,23				ae max. = 0,02 x D	240	0,015	0,030	0,040	0,055	0,07	0,09	0,11
	≥ 750 N/mm ²	110	0,024	0,048	0,064	0,092	0,11	0,15	0,18					120	0,011	0,021	0,028	0,040	0,05	0,06	0,08
S	Ni-based	60	0,019	0,039	0,052	0,074	0,09	0,12	0,15				ae max. = 0,02 x D	60	0,008	0,017	0,022	0,032	0,04	0,05	0,06
	Ti-based	110	0,028	0,055	0,074	0,104	0,12	0,17	0,21					120	0,013	0,026	0,035	0,050	0,06	0,08	0,10
K	≤ 240 HB	300	0,038	0,076	0,101	0,150	0,18	0,24	0,30				ae max. = 0,02 x D	320	0,018	0,036	0,048	0,072	0,09	0,11	0,14
	≥ 240 HB	260	0,035	0,069	0,092	0,127	0,15	0,20	0,25					280	0,017	0,033	0,044	0,061	0,07	0,10	0,12
N	≤ 7 % Si	900	0,045	0,090	0,120	0,184	0,22	0,29	0,37				ae max. = 0,02 x D	1000	0,021	0,043	0,057	0,088	0,11	0,14	0,18
	≥ 7 % Si	430	0,038	0,076	0,101	0,138	0,17	0,22	0,28					460	0,018	0,036	0,048	0,066	0,08	0,11	0,13



Ratio end mills Superfinish RF 100 SF 90°



- GUHRING NAVIGATOR**
Cutting data page 328
- P** •
 - M** •
 - K** •
 - N** •
 - S** •
 - H** •
- without corner protection chamfer
 - neck clearance
 - centre cutting

Tool material	Solid carbide
Surface	a
Type	NH
Shank form	HA



Steel, cast iron and hardened steel

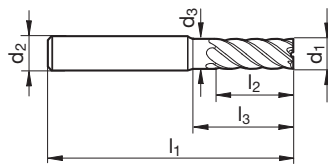

Article no. **6763**

d1 h10	d2 h6	d3	l1	l2	l3	Z	Code no.
mm	mm	mm	mm	mm	mm		
4.00	6.00	3.80	65	12.0	26.0	5	4.000
5.00	6.00	4.80	65	15.0	26.0	5	5.000
6.00	6.00	5.70	65	18.0	28.0	5	6.000
8.00	8.00	7.70	75	24.0	38.0	5	8.000
10.00	10.00	9.50	80	30.0	38.0	5	10.000
12.00	12.00	11.50	93	36.0	46.0	5	12.000
16.00	16.00	15.50	108	48.0	58.0	5	16.000
20.00	20.00	19.50	126	60.0	74.0	5	20.000

ISO	Hardness	vc	fz (mm/z) / Ø								vc	fz (mm/z) / Ø							
			3	6	8	10	12	16	20	3		6	8	10	12	16	20		
P	≤ 850 N/mm ²	340	0,036	0,072	0,096	0,138	0,17	0,22	0,28	360	0,017	0,034	0,046	0,066	0,08	0,11	0,13		
	≥ 850 N/mm ²	250	0,031	0,062	0,083	0,115	0,14	0,18	0,23	270	0,015	0,030	0,040	0,055	0,07	0,09	0,11		
M	≤ 750 N/mm ²	220	0,031	0,062	0,083	0,115	0,14	0,18	0,23	240	0,015	0,030	0,040	0,055	0,07	0,09	0,11		
	≥ 750 N/mm ²	110	0,024	0,048	0,064	0,092	0,11	0,15	0,18	120	0,011	0,021	0,028	0,040	0,05	0,06	0,08		
S	Ni-based	60	0,019	0,039	0,052	0,074	0,09	0,12	0,15	60	0,008	0,017	0,022	0,032	0,04	0,05	0,06		
	Ti-based	110	0,028	0,055	0,074	0,104	0,12	0,17	0,21	120	0,013	0,026	0,035	0,050	0,06	0,08	0,10		
K	≤ 240 HB	300	0,038	0,076	0,101	0,150	0,18	0,24	0,30	320	0,018	0,036	0,048	0,072	0,09	0,11	0,14		
	≥ 240 HB	260	0,035	0,069	0,092	0,127	0,15	0,20	0,25	280	0,017	0,033	0,044	0,061	0,07	0,10	0,12		
N	≤ 7 % Si	900	0,045	0,090	0,120	0,184	0,22	0,29	0,37	1000	0,021	0,043	0,057	0,088	0,11	0,14	0,18		
	≥ 7 % Si	430	0,038	0,076	0,101	0,138	0,17	0,22	0,28	460	0,018	0,036	0,048	0,066	0,08	0,11	0,13		

Multi-tooth end mills GH 100 U



- P** •
- M** •
- K** •
- N** •
- S** •
- H** ○

GUHRING NAVIGATOR

Cutting data page 330

• centre cutting

Tool material	Solid carbide	
Surface	○	Ⓡ
Type	NH	NH
Shank form	HA	HA

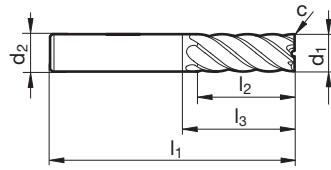

Article no. **3311** **3689**

d1 h10	d2 h6	l1	l2	l3	c	Z	Code no.
mm	mm	mm	mm	mm	mm x 45°		
3.00	6.00	57	8.0	11.4	0.05	6	3.000
4.00	6.00	57	11.0	15.9	0.05	6	4.000
5.00	6.00	57	13.0	17.9	0.05	6	5.000
6.00	6.00	57	13.0	21.0	0.05	6	6.000
8.00	8.00	63	19.0	27.0	0.10	6	8.000
10.00	10.00	72	22.0	32.0	0.10	6	10.000
12.00	12.00	83	26.0	38.0	0.10	6	12.000
14.00	14.00	83	26.0	38.0	0.15	6	14.000
14.00	16.00	92	32.0	40.0	0.15	6	14.001
16.00	16.00	92	32.0	44.0	0.15	6	16.000
18.00	18.00	92	32.0	44.0	0.15	8	18.000
18.00	20.00	104	38.0	48.0	0.15	8	18.001
20.00	20.00	104	38.0	54.0	0.15	8	20.000
25.00	25.00	121	45.0	65.0	0.20	10	25.000

ISO	Hardness	vc	fz (mm/z) / Ø							vc	fz (mm/z) / Ø						
			3	6	8	10	12	16	20		3	6	8	10	12	16	20
P	≤ 850 N/mm ²	220	0,028	0,055	0,074	0,104	0,12	0,17	0,21	240	0,013	0,026	0,035	0,050	0,06	0,08	0,10
	≥ 850 N/mm ²	170	0,026	0,052	0,070	0,097	0,12	0,15	0,19		180	0,013	0,025	0,033	0,046	0,06	0,07
M	≤ 750 N/mm ²	150	0,026	0,052	0,070	0,097	0,12	0,15	0,19	160	0,013	0,025	0,033	0,046	0,06	0,07	0,09
	≥ 750 N/mm ²	70	0,023	0,046	0,061	0,081	0,10	0,13	0,16		80	0,010	0,020	0,026	0,035	0,04	0,06
S	Ni-based	40	0,017	0,035	0,046	0,069	0,08	0,11	0,14	40	0,008	0,015	0,020	0,030	0,04	0,05	0,06
	Ti-based	70	0,023	0,046	0,061	0,087	0,10	0,14	0,17		80	0,011	0,022	0,029	0,042	0,05	0,07
K	≤ 240 HB	190	0,028	0,055	0,074	0,104	0,12	0,17	0,21	210	0,013	0,026	0,035	0,050	0,06	0,08	0,10
	≥ 240 HB	170	0,026	0,052	0,070	0,097	0,12	0,15	0,19		180	0,013	0,025	0,033	0,046	0,06	0,07

Please reduce cutting values for bright finish tools: vc -50% and fz -25%



Multi-tooth end mills GH 100 U

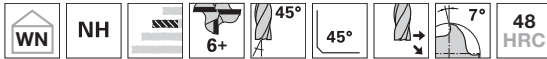

- P** • **GUHRING NAVIGATOR**
- M** • Cutting data page 330
- K** •
- N** •
- S** •
- H** ○ • centre cutting

Tool material	Solid carbide
Surface	F
Type	NH
Shank form	HB

Steel, cast iron and hardened steel

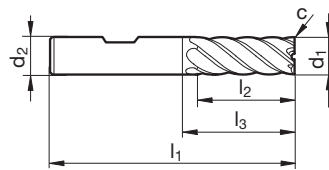

Article no. **3047**

d1 h10	d2 h6	l1	l2	l3	c	Z	Code no.
mm	mm	mm	mm	mm	mm x 45°		
6.00	6.00	57	13.0	21.0	0.05	6	6.000
8.00	8.00	63	19.0	27.0	0.10	6	8.000
10.00	10.00	72	22.0	32.0	0.10	6	10.000
12.00	12.00	83	26.0	38.0	0.10	6	12.000
14.00	14.00	83	26.0	38.0	0.15	6	14.000
16.00	16.00	92	32.0	44.0	0.15	6	16.000
18.00	18.00	92	32.0	44.0	0.15	8	18.000
20.00	20.00	104	38.0	54.0	0.15	8	20.000
25.00	25.00	121	45.0	65.0	0.20	10	25.000
25.00	25.00	121	45.0	65.0	0.20	8	25.001
32.00	32.00	133	53.0	73.0	0.30	8	32.000

ISO	Hardness	vc	fz (mm/z) / Ø								vc	fz (mm/z) / Ø							
			3	6	8	10	12	16	20	3		6	8	10	12	16	20		
			ap = l2		HPC	HSC		ae max. = 0,10 x D				ap = l2			ae max. = 0,02 x D				
P	≤ 850 N/mm ²	220	0,028	0,055	0,074	0,104	0,12	0,17	0,21	240	0,013	0,026	0,035	0,050	0,06	0,08	0,10		
	≥ 850 N/mm ²	170	0,026	0,052	0,070	0,097	0,12	0,15	0,19	180	0,013	0,025	0,033	0,046	0,06	0,07	0,09		
M	≤ 750 N/mm ²	150	0,026	0,052	0,070	0,097	0,12	0,15	0,19	160	0,013	0,025	0,033	0,046	0,06	0,07	0,09		
	≥ 750 N/mm ²	70	0,023	0,046	0,061	0,081	0,10	0,13	0,16	80	0,010	0,020	0,026	0,035	0,04	0,06	0,07		
S	Ni-based	40	0,017	0,035	0,046	0,069	0,08	0,11	0,14	40	0,008	0,015	0,020	0,030	0,04	0,05	0,06		
	Ti-based	70	0,023	0,046	0,061	0,087	0,10	0,14	0,17	80	0,011	0,022	0,029	0,042	0,05	0,07	0,08		
K	≤ 240 HB	190	0,028	0,055	0,074	0,104	0,12	0,17	0,21	210	0,013	0,026	0,035	0,050	0,06	0,08	0,10		
	≥ 240 HB	170	0,026	0,052	0,070	0,097	0,12	0,15	0,19	180	0,013	0,025	0,033	0,046	0,06	0,07	0,09		

Multi-tooth end mills GH 100 U



- P** • **GUHRING NAVIGATOR**
- M** • Cutting data page 330
- K** •
- N** •
- S** ○
- H** • centre cutting

Tool material	Solid carbide	
Surface	○	Ⓡ
Type	NH	NH
Shank form	HA	HA

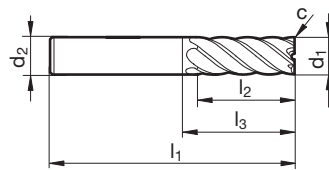

Article no. **3312** **3691**

d1 h10	d2 h6	l1	l2	l3	c	Z	Code no.
mm	mm	mm	mm	mm	mm x 45°		
6.00	6.00	75	30.0	39.0	0.05	6	6.000
8.00	8.00	100	40.0	64.0	0.10	6	8.000
10.00	10.00	100	40.0	60.0	0.10	6	10.000
12.00	12.00	150	45.0	105.0	0.10	6	12.000
16.00	16.00	150	65.0	102.0	0.15	6	16.000
20.00	20.00	150	65.0	100.0	0.15	8	20.000
25.00	25.00	150	75.0	94.0	0.20	10	25.000

ISO	Hardness	vc	fz (mm/z) / Ø							vc	fz (mm/z) / Ø						
			3	6	8	10	12	16	20		3	6	8	10	12	16	20
P	≤ 850 N/mm ²	90	0,010	0,019	0,026	0,036	0,043	0,058	0,072	110	0,007	0,013	0,018	0,025	0,030	0,040	0,050
	≥ 850 N/mm ²	60	0,009	0,018	0,024	0,034	0,041	0,054	0,068		80	0,006	0,013	0,017	0,023	0,028	0,037
M	≤ 750 N/mm ²	60	0,009	0,018	0,024	0,034	0,041	0,054	0,068	70	0,006	0,013	0,017	0,023	0,028	0,037	0,046
	≥ 750 N/mm ²	30	0,008	0,016	0,021	0,028	0,034	0,045	0,056		35	0,005	0,010	0,013	0,018	0,021	0,028
S	Ni-based	20	0,006	0,012	0,016	0,024	0,029	0,039	0,048	20	0,004	0,008	0,010	0,015	0,018	0,024	0,030
	Ti-based	30	0,008	0,016	0,021	0,031	0,037	0,049	0,061		35	0,005	0,011	0,015	0,021	0,025	0,033
K	≤ 240 HB	70	0,010	0,019	0,026	0,036	0,043	0,058	0,072	95	0,007	0,013	0,018	0,025	0,030	0,040	0,050
	≥ 240 HB	60	0,009	0,018	0,024	0,034	0,041	0,054	0,068		80	0,006	0,013	0,017	0,023	0,028	0,037

Please reduce cutting values for bright finish tools: vc -50% and fz -25%



Multi-tooth end mills GH 100 U



P • **GUHRING NAVIGATOR**
M • Cutting data page 330
K •
N •
S ○
H • centre cutting

Tool material	Solid carbide	
Surface	○	Ⓡ
Type	NH	NH
Shank form	HB	HB

Steel, cast iron and hardened steel

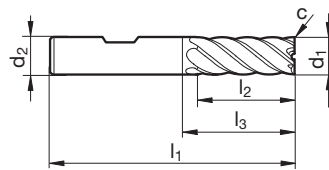

Article no. **3313** **3693**

d1 h10	d2 h6	l1	l2	l3	c	Z	Code no.
mm	mm	mm	mm	mm	mm x 45°		
4.00	6.00	65	16.0	20.9	0.05	6	4.000
5.00	6.00	65	18.0	22.9	0.05	6	5.000
6.00	6.00	75	30.0	39.0	0.05	6	6.000
8.00	8.00	100	40.0	64.0	0.10	6	8.000
10.00	10.00	100	40.0	60.0	0.10	6	10.000
12.00	12.00	150	45.0	105.0	0.10	6	12.000
16.00	16.00	150	65.0	102.0	0.15	6	16.000
20.00	20.00	150	65.0	100.0	0.15	8	20.000
25.00	25.00	150	75.0	94.0	0.20	10	25.000
25.00	25.00	150	75.0	94.0	0.20	8	25.001
32.00	32.00	186	106.0	126.0	0.30	8	32.000

ISO	Hardness	vc	fz (mm/z) / Ø								vc	fz (mm/z) / Ø								
			3	6	8	10	12	16	20	3		6	8	10	12	16	20			
P	≤ 850 N/mm ²	90	0,010	0,019	0,026	0,036	0,043	0,058	0,072	HPC	HSC	ae max. = 0,10 x D	110	0,007	0,013	0,018	0,025	0,030	0,040	0,050
	≥ 850 N/mm ²	60	0,009	0,018	0,024	0,034	0,041	0,054	0,068				80	0,006	0,013	0,017	0,023	0,028	0,037	0,046
M	≤ 750 N/mm ²	60	0,009	0,018	0,024	0,034	0,041	0,054	0,068	HPC	HSC	ae max. = 0,10 x D	70	0,006	0,013	0,017	0,023	0,028	0,037	0,046
	≥ 750 N/mm ²	30	0,008	0,016	0,021	0,028	0,034	0,045	0,056				35	0,005	0,010	0,013	0,018	0,021	0,028	0,035
S	Ni-based	20	0,006	0,012	0,016	0,024	0,029	0,039	0,048	HPC	HSC	ae max. = 0,10 x D	20	0,004	0,008	0,010	0,015	0,018	0,024	0,030
	Ti-based	30	0,008	0,016	0,021	0,031	0,037	0,049	0,061				35	0,005	0,011	0,015	0,021	0,025	0,033	0,042
K	≤ 240 HB	70	0,010	0,019	0,026	0,036	0,043	0,058	0,072	HPC	HSC	ae max. = 0,10 x D	95	0,007	0,013	0,018	0,025	0,030	0,040	0,050
	≥ 240 HB	60	0,009	0,018	0,024	0,034	0,041	0,054	0,068				80	0,006	0,013	0,017	0,023	0,028	0,037	0,046

Please reduce cutting values for bright finish tools: vc -50% and fz -25%

RF 100 H - High performance end mills for hardened steels also above 63 HRC

Ratio®

RF 100 H

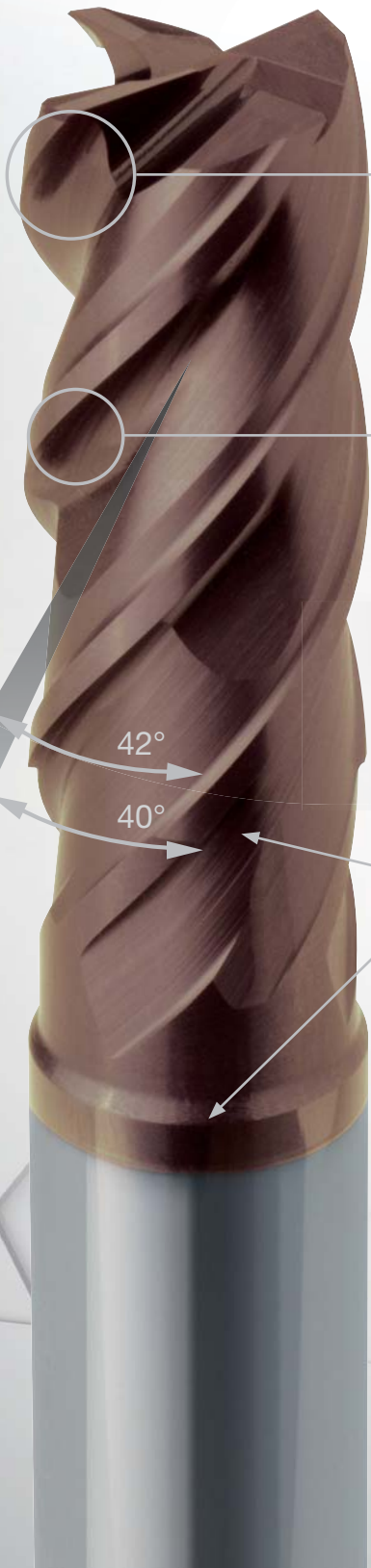

robust cutting edges
with negative helix angle
and extremely hard Signum-coating

high running smoothness
thanks to unequal helix angles
and extremely hard Signum-coating

maximum stability
thanks to extremely thick core diameter
and neck clearance with flat transition angles

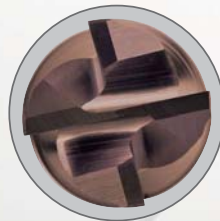

stable face cutting edges
with centre cutting

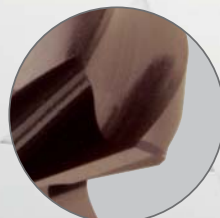

micro-corner protection
for longer tool life

Longer tool life
thanks to improved
Signum coating



Ratio end mills RF 100 H

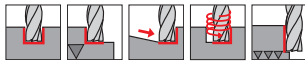

P **GUHRING NAVIGATOR**

M Cutting data page 329

- K**
- N**
- S**
- H**

- Flutes to max. 55 HRC
- re-inforced core
- neck clearance
- centre cutting

Tool material	Solid carbide	
Surface		
Type	H	H
Shank form	HA	HB

Steel, cast iron and hardened steel

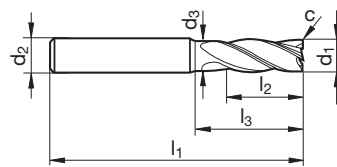

								Article no.	3895	3896
d1 h10	d2 h6	d3	l1	l2	l3	c	Z	Code no.		
mm	mm	mm	mm	mm	mm	mm x 45°				
6.00	6.00	5.70	57	13.0	20.0	0.15	4	6.000		
8.00	8.00	7.70	63	19.0	26.0	0.15	4	8.000		
10.00	10.00	9.50	72	22.0	30.0	0.20	4	10.000		
12.00	12.00	11.50	83	26.0	36.0	0.20	4	12.000		
16.00	16.00	15.50	92	32.0	42.0	0.35	4	16.000		
20.00	20.00	19.50	104	38.0	52.0	0.45	4	20.000		

ISO	Hardness	vc	fz (mm/z) / Ø							vc	fz (mm/z) / Ø						
			3	6	8	10	12	16	20		3	6	8	10	12	16	20
P	≥ 1000 N/mm ²	270	0,034	0,068	0,090	0,125	0,15	0,20	0,25	270	0,015	0,030	0,040	0,055	0,07	0,09	0,11
K	≥ 300 HB	280	0,038	0,075	0,100	0,138	0,17	0,22	0,28	280	0,017	0,033	0,044	0,061	0,07	0,10	0,12
H	≤ 55 HRC	140	0,026	0,053	0,070	0,100	0,12	0,16	0,20	140	0,011	0,021	0,028	0,040	0,05	0,06	0,08
		80	0,021	0,042	0,056	0,075	0,09	0,12	0,15	100	0,008	0,015	0,020	0,027	0,03	0,04	0,05

Hard profile cutters with Torus grind GF 300 T

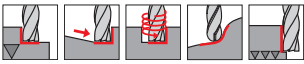
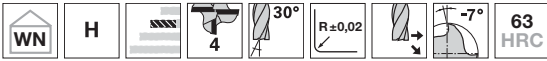

P	○
M	○
K	●
N	○
S	○
H	●

GUHRING NAVIGATOR

Cutting data page 333

- neck clearance
- centre cutting

Tool material	Solid carbide
Surface	Y
Type	H
Shank form	HA

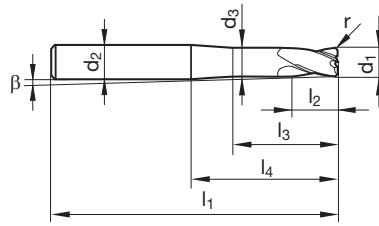

Article no. **3361**

d1 h8	d2 h6	d3	l1	l2	l3	l4	r	β	Z	Code no.
mm	mm	mm	mm	mm	mm	mm	mm	°		
1.00	4.00	0.95	50	2.0	6.0	20.0	0.20	4.00	2	1.002
2.00	6.00	1.90	57	3.0	8.0	21.0	0.20	5.50	2	2.002
2.00	6.00	1.90	57	3.0	8.0	21.0	0.50	5.60	2	2.005
3.00	6.00	2.80	57	5.0	14.0	21.0	0.50	4.20	4	3.000
3.00	6.00	2.80	57	5.0	14.0	21.0	0.30	4.20	4	3.003
4.00	6.00	3.80	57	6.0	16.0	21.0	0.50	2.80	4	4.000
4.00	6.00	3.80	57	6.0	16.0	21.0	0.30	2.80	4	4.003
5.00	6.00	4.80	57	8.0	18.0	21.0	0.50	1.40	4	5.000
5.00	6.00	4.80	57	8.0	18.0	21.0	0.30	1.40	4	5.003
6.00	6.00	5.70	57	9.0	20.0	21.0	1.00		4	6.000
6.00	6.00	5.70	57	9.0	20.0	21.0	0.30		4	6.003
6.00	6.00	5.70	57	9.0	20.0	21.0	0.50		4	6.005
6.00	6.00	5.70	57	9.0	20.0	21.0	1.50		4	6.015
8.00	8.00	7.70	63	12.0	26.0	27.0	1.00		4	8.000
8.00	8.00	7.70	63	12.0	26.0	27.0	0.50		4	8.005
8.00	8.00	7.70	63	12.0	26.0	27.0	2.00		4	8.020
10.00	10.00	9.50	72	15.0	30.0	32.0	1.50		4	10.000
10.00	10.00	9.50	72	15.0	30.0	32.0	0.50		4	10.005
10.00	10.00	9.50	72	15.0	30.0	32.0	1.00		4	10.010
12.00	12.00	11.50	83	18.0	36.0	38.0	1.50		4	12.000
12.00	12.00	11.50	83	18.0	36.0	38.0	0.50		4	12.005
12.00	12.00	11.50	83	18.0	36.0	38.0	1.00		4	12.010
12.00	12.00	11.50	83	18.0	36.0	38.0	2.00		4	12.020
16.00	16.00	15.50	92	24.0	42.0	44.0	2.00		4	16.000
16.00	16.00	15.50	92	24.0	42.0	44.0	3.00		4	16.030

ISO	Hardness	vc	fz (mm/z) / Ø							vc	fz (mm/z) / Ø						
			2	3	4	6	8	10	12		2	3	4	6	8	10	12
P	≤ 850 N/mm ²	200	0,024	0,036	0,048	0,072	0,096	0,120	0,144	300	0,017	0,025	0,034	0,050	0,067	0,084	0,101
	≥ 850 N/mm ²	120	0,024	0,036	0,048	0,072	0,096	0,120	0,144	200	0,017	0,025	0,034	0,050	0,067	0,084	0,101
H	≤ 55 HRC	90	0,020	0,030	0,040	0,060	0,080	0,100	0,120	160	0,013	0,020	0,026	0,039	0,052	0,065	0,078
	55 - 63 HRC	180	0,026	0,039	0,052	0,078	0,104	0,130	0,156	270	0,018	0,027	0,036	0,055	0,073	0,091	0,109
K	≥ 240 HB	220	0,030	0,045	0,060	0,090	0,120	0,150	0,180	360	0,018	0,027	0,036	0,054	0,072	0,090	0,108



Hard profile cutters with Torus grind GF 300 T

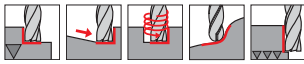
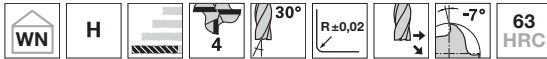

P ○ **GUHRING NAVIGATOR**
Cutting data page 333

M □

K ●

N □

S □

H ●

- neck clearance
- centre cutting

Tool material	Solid carbide
Surface	Y
Type	H
Shank form	HA

Steel, cast iron and hardened steel

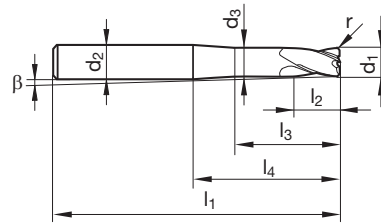

Article no. **3362**

d1 h8	d2 h6	d3	l1	l2	l3	l4	r	β	Z	Code no.
mm	mm	mm	mm	mm	mm	mm	mm	°		
1.00	4.00	0.95	50	2.0	12.0	20.0	0.20	4.40	2	1.002
2.00	6.00	1.90	75	3.0	18.0	35.0	0.50	3.40	2	2.005
3.00	6.00	2.80	75	5.0	25.0	39.0	0.30	2.30	4	3.003
3.00	6.00	2.80	75	5.0	25.0	39.0	0.50	2.30	4	3.005
4.00	6.00	3.80	75	6.0	32.0	39.0	0.30	1.50	4	4.003
4.00	6.00	3.80	75	6.0	32.0	39.0	0.50	1.50	4	4.005
5.00	6.00	4.80	75	8.0	38.0	39.0	0.50	0.80	4	5.005
6.00	6.00	5.70	75	9.0	38.0	39.0	1.00		4	6.000
6.00	6.00	5.70	75	9.0	38.0	39.0	0.50		4	6.005
8.00	8.00	7.70	100	12.0	59.0	60.0	1.00		4	8.000
8.00	8.00	7.70	100	12.0	59.0	60.0	0.50		4	8.005
10.00	10.00	9.50	100	15.0	58.0	60.0	1.50		4	10.000
10.00	10.00	9.50	100	15.0	58.0	60.0	0.50		4	10.005
10.00	10.00	9.50	100	15.0	58.0	60.0	1.00		4	10.010
10.00	10.00	9.50	100	15.0	58.0	60.0	2.00		4	10.020
12.00	12.00	11.50	150	18.0	98.0	100.0	1.50		4	12.000
12.00	12.00	11.50	150	18.0	98.0	100.0	0.50		4	12.005
12.00	12.00	11.50	150	18.0	98.0	100.0	1.00		4	12.010
12.00	12.00	11.50	150	18.0	98.0	100.0	2.00		4	12.020
16.00	16.00	15.50	150	24.0	98.0	100.0	2.00		4	16.000

ISO	Hardness	vc	fz (mm/z) / Ø							vc	fz (mm/z) / Ø						
			2	3	4	6	8	10	12		2	3	4	6	8	10	12
P	≤ 850 N/mm ²	100	0,012	0,018	0,024	0,036	0,048	0,060	0,072	150	0,008	0,013	0,017	0,025	0,034	0,042	0,050
	≥ 850 N/mm ²	60	0,012	0,018	0,024	0,036	0,048	0,060	0,072	100	0,008	0,013	0,017	0,025	0,034	0,042	0,050
H	≤ 55 HRC	50	0,010	0,015	0,020	0,030	0,040	0,050	0,060	80	0,007	0,010	0,013	0,020	0,026	0,033	0,039
	55 - 63 HRC	90	0,013	0,020	0,026	0,039	0,052	0,065	0,078	135	0,009	0,014	0,018	0,027	0,036	0,046	0,055
K	≥ 240 HB	220	0,030	0,045	0,060	0,090	0,120	0,150	0,180	360	0,018	0,027	0,036	0,054	0,072	0,090	0,108

Hard roughing end mills GS 100 H (fine teeth)

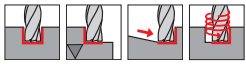
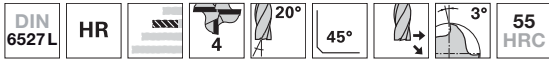

P • **GUHRING NAVIGATOR**

M Cutting data page 331

- K** •
- N**
- S**
- H** •

- with internal coolant supply
- centre cutting

Tool material	Solid carbide	
Surface	Y	Y
Type	HR	HR
Shank form	HA	HB

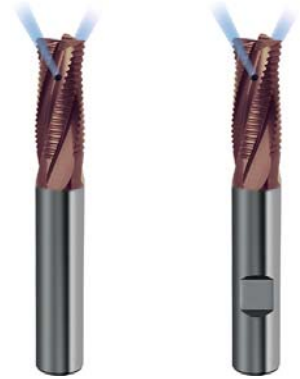
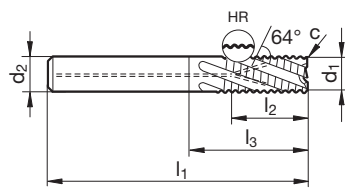

Article no. **6704** **6705**

d1 h10	d2 h6	l1	l2	l3	c	Z	Code no.
mm	mm	mm	mm	mm	mm x 45°		
6.00	6.00	57	13.0	21.0	0.30	4	6.000
8.00	8.00	63	19.0	27.0	0.30	4	8.000
10.00	10.00	72	22.0	32.0	0.30	4	10.000
12.00	12.00	83	26.0	38.0	0.50	4	12.000
16.00	16.00	92	32.0	44.0	0.50	4	16.000
20.00	20.00	104	38.0	54.0	0.50	4	20.000
25.00	25.00	121	45.0	65.0	0.60	4	25.000

ISO	Hardness	vc	fz (mm/z) / Ø							vc	fz (mm/z) / Ø						
			3	6	8	10	12	16	20		3	6	8	10	12	16	20
P	≥ 850 N/mm ²	90	0,008	0,015	0,020	0,028	0,034	0,045	0,056	110	0,009	0,017	0,023	0,032	0,039	0,052	0,064
K	≥ 240 HB	90	0,008	0,015	0,020	0,028	0,034	0,045	0,056	110	0,009	0,017	0,023	0,032	0,039	0,052	0,064
H	≤ 55 HRC	50	0,005	0,011	0,014	0,020	0,024	0,032	0,040	70	0,007	0,014	0,019	0,026	0,031	0,042	0,052



Hard roughing end mills GS 100 H (fine teeth)

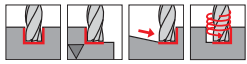
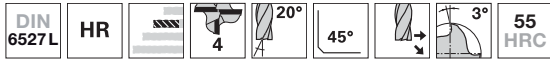

P • **GUHRING NAVIGATOR**
 Cutting data page 331

M

K •

N

S

H • • centre cutting

Tool material	Solid carbide
Surface	Y
Type	HR
Shank form	HB

Steel, cast iron and hardened steel

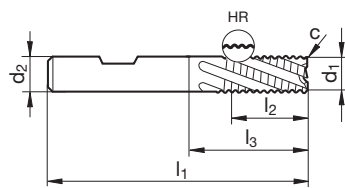

Article no. **3682**

d1 h10	d2 h6	l1	l2	l3	c	Z	Code no.
mm	mm	mm	mm	mm	mm x 45°		
6.00	6.00	57	13.0	21.0	0.30	4	6.000
8.00	8.00	63	19.0	27.0	0.30	4	8.000
10.00	10.00	72	22.0	32.0	0.30	4	10.000
12.00	12.00	83	26.0	38.0	0.50	4	12.000
16.00	16.00	92	32.0	44.0	0.50	4	16.000
20.00	20.00	104	38.0	54.0	0.50	4	20.000

ISO	Hardness	vc	fz (mm/z) / Ø							vc	fz (mm/z) / Ø						
			3	6	8	10	12	16	20		3	6	8	10	12	16	20
P	≥ 850 N/mm ²	90	0,008	0,015	0,020	0,028	0,034	0,045	0,056	110	0,009	0,017	0,023	0,032	0,039	0,052	0,064
K	≥ 240 HB	90	0,008	0,015	0,020	0,028	0,034	0,045	0,056	110	0,009	0,017	0,023	0,032	0,039	0,052	0,064
H	≤ 55 HRC	50	0,005	0,011	0,014	0,020	0,024	0,032	0,040	70	0,007	0,014	0,019	0,026	0,031	0,042	0,052

Hard multi-tooth end mills corner radius GH 100 H

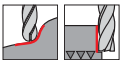
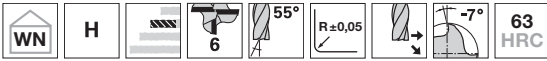

P **GUHRING** NAVIGATOR

Cutting data page 330

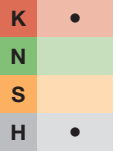

- neck clearance
- centre cutting

Tool material **Solid carbide**

Surface **Y**

Type **H**

Shank form **HA**

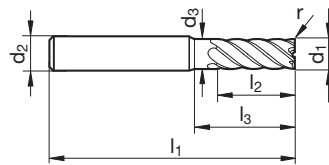

Article no. **4270**

d1 h10	d2 h6	d3	l1	l2	l3	r	Z	Code no.
mm	mm	mm	mm	mm	mm	mm		
3.00	6.00	2.80	57	8.0	11.4	0.3	6	3.003
6.00	6.00	5.70	57	13.0	20.0	1.0	6	6.010
8.00	8.00	7.70	63	19.0	26.0	0.5	6	8.005
8.00	8.00	7.70	63	19.0	26.0	1.0	6	8.010
10.00	10.00	9.50	72	22.0	30.0	0.5	6	10.005
10.00	10.00	9.50	72	22.0	30.0	1.0	6	10.010
10.00	10.00	9.50	72	22.0	30.0	1.5	6	10.015
12.00	12.00	11.50	83	26.0	36.0	0.5	6	12.005
12.00	12.00	11.50	83	26.0	36.0	1.0	6	12.010
12.00	12.00	11.50	83	26.0	36.0	1.5	6	12.015
16.00	16.00	15.50	92	32.0	42.0	1.0	6	16.010
16.00	16.00	15.50	92	32.0	42.0	2.0	6	16.020

ISO	Hardness	vc	fz (mm/z) / Ø								vc	fz (mm/z) / Ø							
			3	6	8	10	12	16	20	3		6	8	10	12	16	20		
P	≥ 1000 N/mm ²	180	0,029	0,057	0,076	0,105	0,13	0,17	0,21	180	0,013	0,025	0,033	0,046	0,06	0,07	0,09		
K	≥ 300 HB	180	0,029	0,057	0,076	0,105	0,13	0,17	0,21	180	0,013	0,025	0,033	0,046	0,06	0,07	0,09		
H	≤ 55 HRC	100	0,024	0,048	0,064	0,088	0,11	0,14	0,18	110	0,010	0,019	0,026	0,035	0,04	0,06	0,07		
	≥ 55 HRC	70	0,019	0,038	0,050	0,070	0,08	0,11	0,14	80	0,007	0,014	0,018	0,025	0,03	0,04	0,05		



Hard multi-tooth end mills GH 100 H

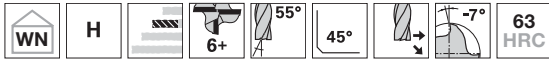

- P** ○
- M** □
- K** ●
- N** □
- S** □
- H** ●

GUHRING NAVIGATOR
Cutting data page 330

● centre cutting

Tool material	Solid carbide
Surface	Y
Type	H
Shank form	HA

Steel, cast iron and hardened steel

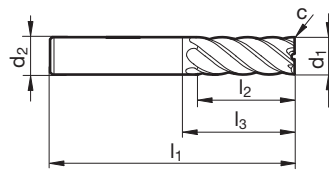

Article no. **3715**

d1 h10	d2 h6	l1	l2	l3	c	Z	Code no.
mm	mm	mm	mm	mm	mm x 45°		
3.00	6.00	57	8.0	11.4	0.05	6	3.000
4.00	6.00	57	11.0	15.9	0.05	6	4.000
5.00	6.00	57	13.0	17.9	0.05	6	5.000
6.00	6.00	57	13.0	21.0	0.05	6	6.000
8.00	8.00	63	19.0	27.0	0.10	6	8.000
10.00	10.00	72	22.0	32.0	0.10	6	10.000
12.00	12.00	83	26.0	38.0	0.10	6	12.000
14.00	14.00	83	26.0	38.0	0.15	6	14.000
14.00	16.00	92	32.0	40.0	0.15	6	14.001
16.00	16.00	92	32.0	44.0	0.15	6	16.000
18.00	18.00	92	32.0	44.0	0.15	8	18.000
18.00	20.00	104	38.0	48.0	0.15	8	18.001
20.00	20.00	104	38.0	54.0	0.15	8	20.000

ISO	Hardness	vc	fz (mm/z) / Ø							vc	fz (mm/z) / Ø						
			3	6	8	10	12	16	20		3	6	8	10	12	16	20
P	≥ 1000 N/mm ²	180	0,029	0,057	0,076	0,105	0,13	0,17	0,21	180	0,013	0,025	0,033	0,046	0,06	0,07	0,09
K	≥ 300 HB	180	0,029	0,057	0,076	0,105	0,13	0,17	0,21	180	0,013	0,025	0,033	0,046	0,06	0,07	0,09
H	≤ 55 HRC	100	0,024	0,048	0,064	0,088	0,11	0,14	0,18	110	0,010	0,019	0,026	0,035	0,04	0,06	0,07
	≥ 55 HRC	70	0,019	0,038	0,050	0,070	0,08	0,11	0,14	80	0,007	0,014	0,018	0,025	0,03	0,04	0,05

Hard multi-tooth end mills GH 100 H

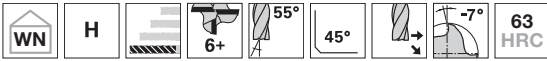

P	○
M	○
K	●
N	○
S	○
H	●

GUHRING NAVIGATOR

Cutting data page 330

● centre cutting

Tool material	Solid carbide
Surface	Y
Type	H
Shank form	HA

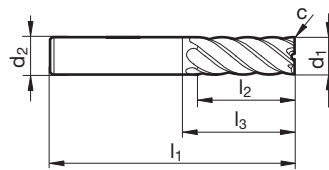

Article no. 3716

d1 h10	d2 h6	l1	l2	l3	c	Z	Code no.
mm	mm	mm	mm	mm	mm x 45°		
6.00	6.00	75	30.0	39.0	0.05	6	6.000
8.00	8.00	100	40.0	64.0	0.10	6	8.000
10.00	10.00	100	40.0	60.0	0.10	6	10.000
12.00	12.00	150	45.0	105.0	0.10	6	12.000
16.00	16.00	150	65.0	102.0	0.15	6	16.000
20.00	20.00	150	65.0	100.0	0.15	8	20.000

ISO	Hardness	vc	fz (mm/z) / Ø							vc	fz (mm/z) / Ø						
			3	6	8	10	12	16	20		3	6	8	10	12	16	20
P	≥ 1000 N/mm ²	70	0,010	0,020	0,027	0,037	0,044	0,059	0,074	80	0,006	0,013	0,017	0,023	0,028	0,037	0,046
K	≥ 300 HB	70	0,010	0,020	0,027	0,037	0,044	0,059	0,074	80	0,006	0,013	0,017	0,023	0,028	0,037	0,046
H	≤ 55 HRC	40	0,008	0,017	0,022	0,031	0,037	0,049	0,061	50	0,005	0,010	0,013	0,018	0,021	0,028	0,035
	≥ 55 HRC	20	0,007	0,013	0,018	0,025	0,029	0,039	0,049	35	0,003	0,007	0,009	0,013	0,015	0,020	0,025

Guhring GM 300 shrink fit technology

Safe connection: GSS shrink fit systems and shrink fit chucks



GSS
2000

Summary of advantages

- ▶ high-performance spindle, hence quick change time
- ▶ automatic mode possible: equipment automatically selects the correct heating program
- ▶ error detection choosing wrong chuck/program



Application example

HPC roughing

Wet machining in X2CrNiMo 17 13 2 (1.4404)

RF100 VA 12 mm; Article no.: 3800 12.0

$a_e = 1,2 \text{ mm} / a_p = 24 \text{ mm}$

$v_c = 120 \text{ m/min}$

$f_z = 0.1 \text{ mm}$

$v_f = 1280 \text{ mm/min}$

Metal removal rate $Q = 37 \text{ cm}^3/\text{min}$

Slot milling

Wet machining in X5CrNi 18 10 (1.4301)

RF100 VA 16 mm; Article no.: 3805 16.0

$a_e = 16 \text{ mm} / a_p = 16 \text{ mm}$

$v_c = 85 \text{ m/min}$

$f_z = 0.06 \text{ mm}$

$v_f = 405 \text{ mm/min}$

Metal removal rate $Q = 103 \text{ cm}^3/\text{min}$



RUOSTUMATON
NEREZOVÁ
INOXIDABLE
STAINLESS
INOXYDABLE
INOX



STAINLESS

SOLID CARBIDE HPC HIGH-PERFORMANCE MILLING CUTTER

For stainless steel and difficult-to-machine alloys



Stainless steel and difficult-to-machine alloys

Stainless steel and difficult-to-machine alloys

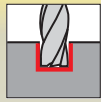

SLOTING

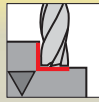

ROUGHING

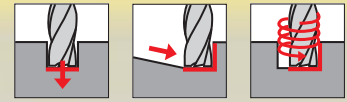

PLUNGING

No.1

M7C

M S

M7C

M

M7C

M

HPC

M

up to approx. Ø 8.00 mm

HPC

M S

No.1

HPC

M S

ramping up to 10°
helix up to $a_p 0.2xD$

No.1

HPC

M

*i*machining a_e up to 0.2xD

HPC

M

HPC

M

up to approx. depth 0.8xD

No.1

HPC

M S

*i*machining a_e up to 0.1xD

HPC

M S

HPC

M S

HPC

M S

*i*machining a_e up to 0.2xD

HPC

M S

M7C

M

with GührJet up to $a_p 2xD$

M7C

M

M7C

M

HPC

M S

*i*machining a_e up to 0.15xD



GÜHRING TROCHOIDAL CUTTING
Dynamic / trochoidal milling



HIGH-PERFORMANCE CUTTING
for max. metal removal rates / time;
rigid conditions, high performance,
good cooling, quick de-clamping



HIGH SPEED CUTTING
with high speeds / high feed rate
low performance, low feed rate



QUICK FINDER

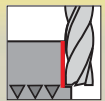

FINISHING

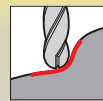

COPYING



RF 100 U Z=3 / Raptor Z=3



i.e.: no. 3891/6728 from p. 75

Stainless steel and difficult-to-machine alloys



More copying milling cutters from p. 171

RF 100 VA / RF 100 Diver



i.e.: no. 6737 from p. 91



RF 100 VA IK / RF 100 F IK



i.e.: no. 6700 from p. 81



RF 100 Speed



i.e.: no. 6765 from p. 97



RF 100 Ti



i.e.: no. 3498 from p. 100

HSS-E-PM-roughing end mills GS 80 p. 292

RF 100 VA / RS 100 U



i.e.: no. 6877 from p. 84

NO.1



RF 100 SF / Raptor



i.e.: no. 3631/6727 from p. 107



MILL TURN CENTER driven tools non-rigid conditions, low drive power medium to long de-clamping, moderate cooling



STAINLESS STEEL



TITAN



IDEAL TOOL

EXPLANATIONS for the Quickfinder see p. 6-7

Standard Ratio end mills RF 100 U (3-fluted)

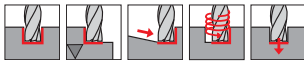

P • **GUHRING NAVIGATOR**

M • Cutting data page 328

K •

N •

S ○

H • neck clearance
• centre cutting

Tool material	Solid carbide	
Surface	F	F
Type	N	N
Shank form	HA	HB

Stainless steel and difficult-to-machine alloys

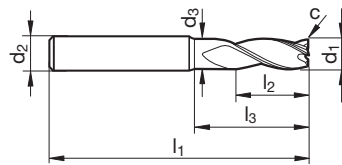

Article no. **3893** **3894**

d1 e8	d2 h6	d3	l1	l2	l3	c	Z	Code no.
mm	mm	mm	mm	mm	mm	mm x 45°		
3.00	6.00	2.80	57	4.0	15.0	0.05	3	3.000
4.00	6.00	3.80	57	5.0	18.0	0.06	3	4.000
5.00	6.00	4.80	57	6.0	18.0	0.08	3	5.000
6.00	6.00	5.70	57	7.0	20.0	0.09	3	6.000
8.00	8.00	7.70	63	9.0	26.0	0.12	3	8.000
10.00	10.00	9.50	72	11.0	30.0	0.15	3	10.000
12.00	12.00	11.50	83	12.0	36.0	0.18	3	12.000
16.00	16.00	15.50	92	16.0	42.0	0.19	3	16.000

ISO	Hardness	vc	fz (mm/z) / Ø								vc	fz (mm/z) / Ø							
			3	6	8	10	12	16	20	3		6	8	10	12	16	20		
P	≤ 850 N/mm ²	180	0,016	0,031	0,042	0,060	0,07	0,10	0,12		210	0,018	0,036	0,048	0,069	0,08	0,11	0,14	
	≥ 850 N/mm ²	135	0,014	0,027	0,036	0,050	0,06	0,08	0,10		160	0,016	0,031	0,041	0,058	0,07	0,09	0,12	
M	≤ 750 N/mm ²	120	0,014	0,027	0,036	0,050	0,06	0,08	0,10		140	0,016	0,031	0,041	0,058	0,07	0,09	0,12	
	≥ 750 N/mm ²	60	0,011	0,021	0,028	0,040	0,05	0,06	0,08		80	0,013	0,025	0,034	0,048	0,06	0,08	0,10	
S	Ni-based	30	0,008	0,017	0,022	0,032	0,04	0,05	0,06		40	0,010	0,020	0,027	0,038	0,05	0,06	0,08	
	Ti-based	60	0,012	0,024	0,032	0,045	0,05	0,07	0,09		80	0,014	0,029	0,038	0,054	0,06	0,09	0,11	
N	≤ 5% Si	500	0,020	0,039	0,052	0,080	0,10	0,13	0,16		600	0,022	0,045	0,060	0,092	0,11	0,15	0,18	
	≥ 5% Si	230	0,017	0,033	0,044	0,060	0,07	0,10	0,12		300	0,019	0,038	0,051	0,069	0,08	0,11	0,14	



Standard Ratio end mills RF 100 U (3-fluted)

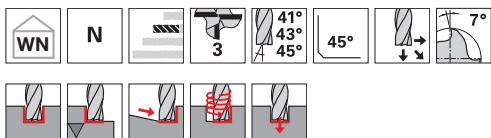

P	•
M	•
K	•
N	•
S	○
H	

GUHRING NAVIGATOR

Cutting data page 328

- neck clearance
- centre cutting

Tool material	Solid carbide	
Surface	F	F
Type	N	N
Shank form	HA	HB

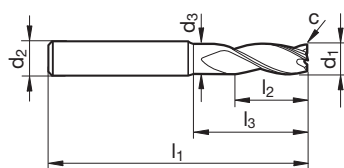

Article no. **3891** **3892**

d1 e8	d2 h6	d3	l1	l2	l3	c	Z	Code no.
mm	mm	mm	mm	mm	mm	mm x 45°		
3.00	6.00	2.80	57	8.0	15.0	0.05	3	3.000
3.50	6.00	3.30	57	10.0	15.0	0.05	3	3.500
3.70	6.00	3.50	57	11.0	15.0	0.06	3	3.700
4.00	6.00	3.80	57	11.0	18.0	0.06	3	4.000
4.50	6.00	4.30	57	11.0	18.0	0.07	3	4.500
4.70	6.00	4.50	57	13.0	18.0	0.07	3	4.700
5.00	6.00	4.80	57	13.0	18.0	0.08	3	5.000
5.50	6.00	5.30	57	13.0	19.4	0.08	3	5.500
5.70	6.00	5.50	57	13.0	19.6	0.09	3	5.700
6.00	6.00	5.70	57	13.0	20.0	0.09	3	6.000
6.50	8.00	6.20	63	16.0	24.4	0.10	3	6.500
7.00	8.00	6.70	63	16.0	24.9	0.11	3	7.000
7.50	8.00	7.20	63	19.0	25.3	0.11	3	7.500
8.00	8.00	7.70	63	19.0	26.0	0.12	3	8.000
8.50	10.00	8.20	72	19.0	29.4	0.13	3	8.500
9.00	10.00	8.70	72	19.0	29.9	0.14	3	9.000
9.50	10.00	9.20	72	22.0	30.3	0.14	3	9.500
10.00	10.00	9.50	72	22.0	30.0	0.15	3	10.000
12.00	12.00	11.50	83	26.0	36.0	0.18	3	12.000
16.00	16.00	15.50	92	32.0	42.0	0.19	3	16.000
20.00	20.00	19.50	104	38.0	52.0	0.24	3	20.000

ISO	Hardness	vc	fz (mm/z) / Ø						vc	fz (mm/z) / Ø							
			3	6	8	10	12	16		20	3	6	8	10	12	16	20
P	≤ 850 N/mm ²	180	0,016	0,031	0,042	0,060	0,07	0,10	0,12	210	0,018	0,036	0,048	0,069	0,08	0,11	0,14
	≥ 850 N/mm ²	135	0,014	0,027	0,036	0,050	0,06	0,08	0,10	160	0,016	0,031	0,041	0,058	0,07	0,09	0,12
M	≤ 750 N/mm ²	120	0,014	0,027	0,036	0,050	0,06	0,08	0,10	140	0,016	0,031	0,041	0,058	0,07	0,09	0,12
	≥ 750 N/mm ²	60	0,011	0,021	0,028	0,040	0,05	0,06	0,08	80	0,013	0,025	0,034	0,048	0,06	0,08	0,10
S	Ni-based	30	0,008	0,017	0,022	0,032	0,04	0,05	0,06	40	0,010	0,020	0,027	0,038	0,05	0,06	0,08
	Ti-based	60	0,012	0,024	0,032	0,045	0,05	0,07	0,09	80	0,014	0,029	0,038	0,054	0,06	0,09	0,11
N	≤ 5% Si	500	0,020	0,039	0,052	0,080	0,10	0,13	0,16	600	0,022	0,045	0,060	0,092	0,11	0,15	0,18
	≥ 5% Si	230	0,017	0,033	0,044	0,060	0,07	0,10	0,12	300	0,019	0,038	0,051	0,069	0,08	0,11	0,14

Stainless steel and difficult-to-machine alloys

RF 100 Raptor – Ratio End Mill

Raptor-coating for **perfect chip evacuation**

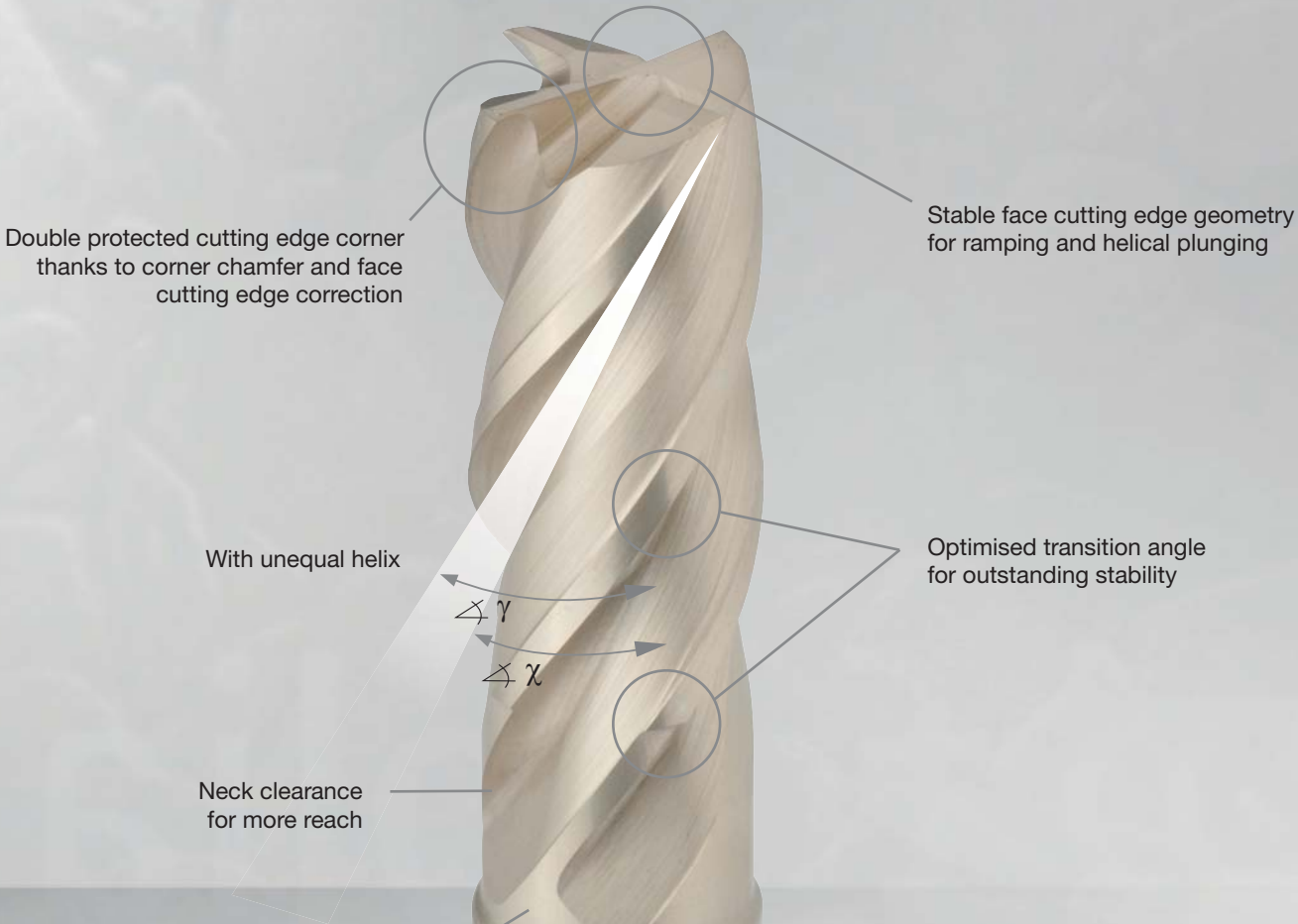

raptor[®]-coating

High performance
In three designs for slotting, roughing and finishing.

The zirconium-based cover coating prevents chemical reactions, reliably protecting against built-up edge and ensures optimal machining results in steel materials, titanium and stainless materials.

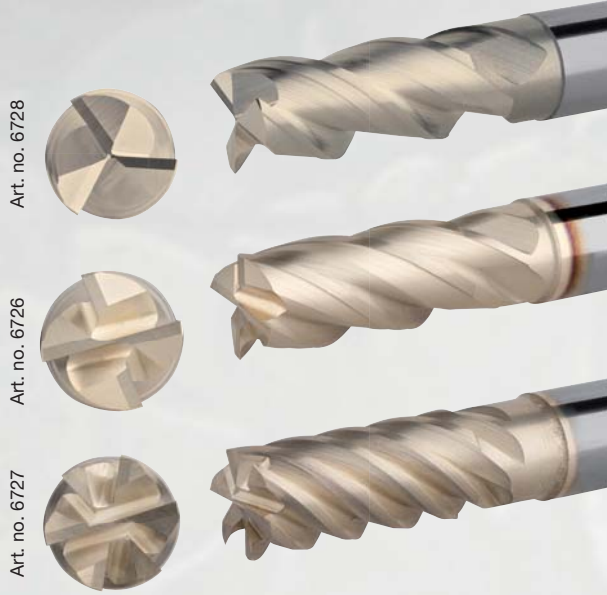



Standard Ratio end mills RF 100 U (3-fluted)

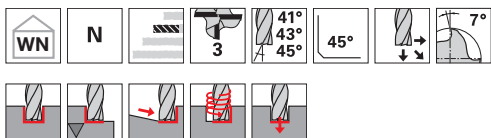

Tool material	Solid carbide
Surface	R
Type	N
Shank form	HB



P • **GUHRING NAVIGATOR**

M • Cutting data page 328

K

N •

S • Raptor® coating

• neck clearance

H • centre cutting

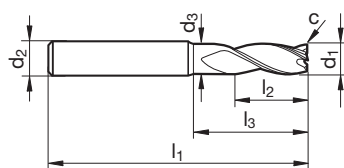

Stainless steel and difficult-to-machine alloys

Article no. **6728**

d1 e8	d2 h6	d3	l1	l2	l3	c	Z	Code no.
mm	mm	mm	mm	mm	mm	mm x 45°		
3.00	6.00	2.80	57	8.0	15.0	0.05	3	3.000
4.00	6.00	3.80	57	11.0	18.0	0.06	3	4.000
6.00	6.00	5.70	57	13.0	20.0	0.09	3	6.000
8.00	8.00	7.70	63	19.0	26.0	0.12	3	8.000
10.00	10.00	9.50	72	22.0	30.0	0.15	3	10.000
12.00	12.00	11.50	83	26.0	36.0	0.18	3	12.000
16.00	16.00	15.50	92	32.0	42.0	0.19	3	16.000
20.00	20.00	19.50	104	38.0	52.0	0.24	3	20.000

ISO	Hardness	vc	fz (mm/z) / Ø								vc	fz (mm/z) / Ø								
			ap = 1,0 x D				ap = 1,0 x D					ap = 1,0 x D				ap max = 0,75 x D				
			3	6	8	10	12	16	20	3		6	8	10	12	16	20	3	6	8
P	≤ 850 N/mm ²	180	0,016	0,031	0,042	0,060	0,07	0,10	0,12	210	0,018	0,036	0,048	0,069	0,08	0,11	0,14			
	≥ 850 N/mm ²	135	0,014	0,027	0,036	0,050	0,06	0,08	0,10	160	0,016	0,031	0,041	0,058	0,07	0,09	0,12			
M	≤ 750 N/mm ²	120	0,014	0,027	0,036	0,050	0,06	0,08	0,10	140	0,016	0,031	0,041	0,058	0,07	0,09	0,12			
	≥ 750 N/mm ²	60	0,011	0,021	0,028	0,040	0,05	0,06	0,08	80	0,013	0,025	0,034	0,048	0,06	0,08	0,10			
S	Ni-based	30	0,008	0,017	0,022	0,032	0,04	0,05	0,06	40	0,010	0,020	0,027	0,038	0,05	0,06	0,08			
	Ti-based	60	0,012	0,024	0,032	0,045	0,05	0,07	0,09	80	0,014	0,029	0,038	0,054	0,06	0,09	0,11			
N	≤ 5% Si	500	0,020	0,039	0,052	0,080	0,10	0,13	0,16	600	0,022	0,045	0,060	0,092	0,11	0,15	0,18			
	≥ 5% Si	230	0,017	0,033	0,044	0,060	0,07	0,10	0,12	300	0,019	0,038	0,051	0,069	0,08	0,11	0,14			

RF 100 VA – High-performance end mills for soft, tough and stainless steels

Ratio®

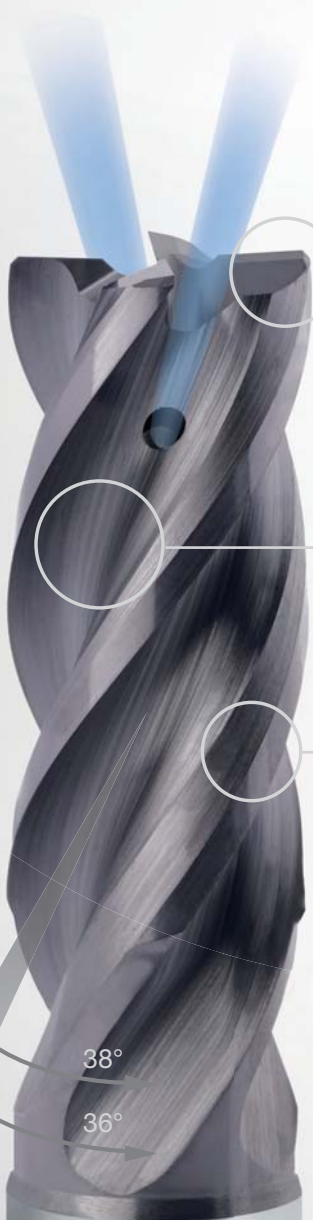

stable cutting edge corner
thanks to large corner protection chamfer and face correction

deep, round flutes
for optimal chip evacuation with reduced heat generation

very smooth running
thanks to unequal helix angle and cutting edge distribution

Summary of advantages:

- ▶ very smooth running and high metal removal rate
- ▶ for slotting, roughing, copying and finishing operations in steel and stainless materials
- ▶ large choice of dimensions and geometries



available with flattened roughing geometry
e.g.. Art. no. 6877

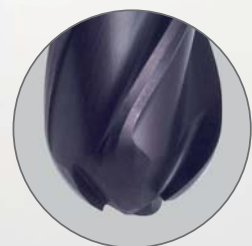

ball nose option also available:
Art. no. 6707



Ratio end mills RF 100 VA

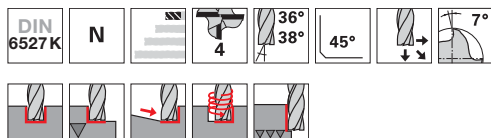

GUHRING NAVIGATOR
Cutting data page 328

P	•
M	•
K	
N	○
S	•
H	

- neck clearance
- centre cutting

Tool material	Solid carbide	
Surface	a	a
Type	N	N
Shank form	HA	HB

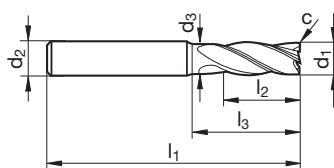

Article no. 3804 3805

d1 h10	d2 h6	d3	l1	l2	l3	c	Z	Code no.
mm	mm	mm	mm	mm	mm	mm x 45°		
4.00	6.00	3.80	54	8.0	15.0	0.15	4	4.000
5.00	6.00	4.80	54	9.0	15.0	0.15	4	5.000
6.00	6.00	5.70	54	10.0	17.0	0.20	4	6.000
8.00	8.00	7.70	58	12.0	21.0	0.25	4	8.000
10.00	10.00	9.50	66	14.0	24.0	0.30	4	10.000
12.00	12.00	11.50	73	16.0	26.0	0.35	4	12.000
16.00	16.00	15.50	82	22.0	32.0	0.50	4	16.000
20.00	20.00	19.50	92	26.0	40.0	0.60	4	20.000

ISO	Hardness	vc	fz (mm/z) / Ø								vc	fz (mm/z) / Ø							
			3	6	8	10	12	16	20	3		6	8	10	12	16	20		
P	≤ 850 N/mm ²	180	0,016	0,031	0,042	0,060	0,07	0,10	0,12	305	0,025	0,050	0,067	0,096	0,12	0,15	0,19		
	≥ 850 N/mm ²	135	0,014	0,027	0,036	0,050	0,06	0,08	0,10	230	0,022	0,043	0,058	0,080	0,10	0,13	0,16		
M	≤ 750 N/mm ²	120	0,014	0,027	0,036	0,050	0,06	0,08	0,10	205	0,022	0,043	0,058	0,080	0,10	0,13	0,16		
	≥ 750 N/mm ²	60	0,011	0,021	0,028	0,040	0,05	0,06	0,08	100	0,017	0,034	0,045	0,064	0,08	0,10	0,13		
S	Ni-based	30	0,008	0,017	0,022	0,032	0,04	0,05	0,06	50	0,013	0,027	0,036	0,051	0,06	0,08	0,10		
	Ti-based	60	0,012	0,024	0,032	0,045	0,05	0,07	0,09	100	0,019	0,038	0,051	0,072	0,09	0,12	0,14		

Stainless steel and difficult-to-machine alloys

Ratio end mills RF 100 VA

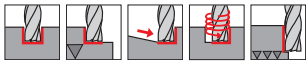

GUHRING NAVIGATOR
Cutting data page 328

P	•
M	•
K	
N	○
S	•
H	

- neck clearance
- centre cutting

Tool material	Solid carbide	
Surface	a	a
Type	N	N
Shank form	HA	HB

Stainless steel and difficult-to-machine alloys

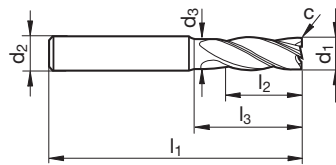

Article no. **3800** **3803**

d1 h10	d2 h6	d3	l1	l2	l3	c	Z	Code no.
mm	mm	mm	mm	mm	mm	mm x 45°		
3.00	6.00	2.80	57	8.0	15.0	0.10	4	3.000
3.50	6.00	3.30	57	10.0	15.0	0.10	4	3.500
4.00	6.00	3.80	57	11.0	18.0	0.15	4	4.000
4.50	6.00	4.30	57	11.0	18.0	0.15	4	4.500
5.00	6.00	4.80	57	13.0	18.0	0.15	4	5.000
5.50	6.00	5.30	57	13.0	19.4	0.20	4	5.500
6.00	6.00	5.70	57	13.0	20.0	0.20	4	6.000
6.50	8.00	6.20	63	16.0	24.4	0.25	4	6.500
7.00	8.00	6.70	63	16.0	24.9	0.25	4	7.000
7.50	8.00	7.20	63	19.0	25.3	0.25	4	7.500
8.00	8.00	7.70	63	19.0	26.0	0.25	4	8.000
8.50	10.00	8.20	72	19.0	29.4	0.30	4	8.500
9.00	10.00	8.70	72	19.0	29.9	0.30	4	9.000
9.50	10.00	9.20	72	22.0	30.3	0.30	4	9.500
10.00	10.00	9.50	72	22.0	30.0	0.30	4	10.000
11.00	12.00	10.50	83	26.0	34.7	0.35	4	11.000
12.00	12.00	11.50	83	26.0	36.0	0.35	4	12.000
14.00	14.00	13.50	83	26.0	36.0	0.40	4	14.000
16.00	16.00	15.50	92	32.0	42.0	0.50	4	16.000
18.00	18.00	17.50	92	32.0	42.0	0.60	4	18.000
20.00	20.00	19.50	104	38.0	52.0	0.60	4	20.000
25.00	25.00	24.00	121	45.0	63.0	0.75	4	25.000

ISO	Hardness	vc	fz (mm/z) / Ø						vc	fz (mm/z) / Ø							
			3	6	8	10	12	16		20	3	6	8	10	12	16	20
P	≤ 850 N/mm ²	180	0,016	0,031	0,042	0,060	0,07	0,10	0,12	305	0,025	0,050	0,067	0,096	0,12	0,15	0,19
	≥ 850 N/mm ²	135	0,014	0,027	0,036	0,050	0,06	0,08	0,10	230	0,022	0,043	0,058	0,080	0,10	0,13	0,16
M	≤ 750 N/mm ²	120	0,014	0,027	0,036	0,050	0,06	0,08	0,10	205	0,022	0,043	0,058	0,080	0,10	0,13	0,16
	≥ 750 N/mm ²	60	0,011	0,021	0,028	0,040	0,05	0,06	0,08	100	0,017	0,034	0,045	0,064	0,08	0,10	0,13
S	Ni-based	30	0,008	0,017	0,022	0,032	0,04	0,05	0,06	50	0,013	0,027	0,036	0,051	0,06	0,08	0,10
	Ti-based	60	0,012	0,024	0,032	0,045	0,05	0,07	0,09	100	0,019	0,038	0,051	0,072	0,09	0,12	0,14



Ratio end mills RF 100 VA

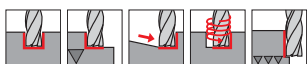

P • **GUHRING NAVIGATOR**

M • Cutting data page 328

K •

N ○

S •

H •

- with internal coolant supply
- neck clearance
- centre cutting

Tool material	Solid carbide	
Surface	a	a
Type	N	N
Shank form	HA	HB

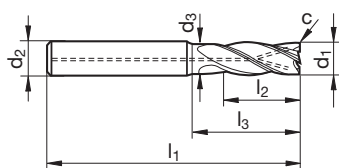

Stainless steel and difficult-to-machine alloys

								Article no.	6700	6701
d1 h10	d2 h6	d3	l1	l2	l3	c	Z	Code no.		
mm	mm	mm	mm	mm	mm	mm x 45°				
6.00	6.00	5.70	57	13.0	20.0	0.20	4	6.000		
8.00	8.00	7.70	63	19.0	26.0	0.25	4	8.000		
10.00	10.00	9.50	72	22.0	30.0	0.30	4	10.000		
12.00	12.00	11.50	83	26.0	36.0	0.35	4	12.000		
16.00	16.00	15.50	92	32.0	42.0	0.50	4	16.000		
20.00	20.00	19.50	104	38.0	52.0	0.60	4	20.000		
25.00	25.00	24.00	121	45.0	63.0	0.75	4	25.000		

ISO	Hardness	vc	fz (mm/z) / Ø								vc	fz (mm/z) / Ø							
			3	6	8	10	12	16	20	3		6	8	10	12	16	20		
			ap = 1,0 x D					ae = 1,0 x D				ap = l2				HPC	ae max = 0,20 x D		
P	≤ 850 N/mm ²	180	0,016	0,031	0,042	0,060	0,07	0,10	0,12	305	0,025	0,050	0,067	0,096	0,12	0,15	0,19		
	≥ 850 N/mm ²	135	0,014	0,027	0,036	0,050	0,06	0,08	0,10	230	0,022	0,043	0,058	0,080	0,10	0,13	0,16		
M	≤ 750 N/mm ²	120	0,014	0,027	0,036	0,050	0,06	0,08	0,10	205	0,022	0,043	0,058	0,080	0,10	0,13	0,16		
	≥ 750 N/mm ²	60	0,011	0,021	0,028	0,040	0,05	0,06	0,08	100	0,017	0,034	0,045	0,064	0,08	0,10	0,13		
S	Ni-based	30	0,008	0,017	0,022	0,032	0,04	0,05	0,06	50	0,013	0,027	0,036	0,051	0,06	0,08	0,10		
	Ti-based	60	0,012	0,024	0,032	0,045	0,05	0,07	0,09	100	0,019	0,038	0,051	0,072	0,09	0,12	0,14		

Ratio end mills RF 100 VA

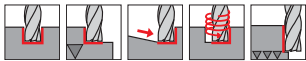

GUHRING NAVIGATOR
Cutting data page 328

P	•
M	•
K	
N	○
S	•
H	

- neck clearance
- centre cutting

Tool material	Solid carbide	
Surface	a	a
Type	N	N
Shank form	HA	HB

Stainless steel and difficult-to-machine alloys

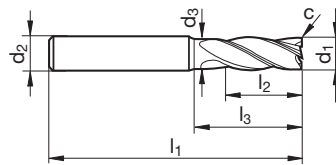

Article no. **3806** **3807**

d1 h10	d2 h6	d3	l1	l2	l3	c	Z	Code no.
mm	mm	mm	mm	mm	mm	mm x 45°		
6.00	6.00	5.70	65	10.0	28.0	0.20	4	6.000
8.00	8.00	7.70	75	12.0	38.0	0.25	4	8.000
10.00	10.00	9.50	80	14.0	38.0	0.30	4	10.000
12.00	12.00	11.50	93	16.0	46.0	0.35	4	12.000
16.00	16.00	15.50	108	22.0	58.0	0.50	4	16.000
20.00	20.00	19.50	126	26.0	74.0	0.60	4	20.000

ISO	Hardness	vc	fz (mm/z) / Ø							vc	fz (mm/z) / Ø						
			3	6	8	10	12	16	20		3	6	8	10	12	16	20
P	≤ 850 N/mm ²	110	0,009	0,019	0,025	0,036	0,04	0,06	0,07	145	0,013	0,025	0,033	0,048	0,06	0,08	0,10
	≥ 850 N/mm ²	80	0,008	0,016	0,022	0,030	0,04	0,05	0,06	110	0,011	0,022	0,029	0,040	0,05	0,06	0,08
M	≤ 750 N/mm ²	70	0,008	0,016	0,022	0,030	0,04	0,05	0,06	100	0,011	0,022	0,029	0,040	0,05	0,06	0,08
	≥ 750 N/mm ²	35	0,006	0,013	0,017	0,024	0,03	0,04	0,05	55	0,009	0,018	0,024	0,034	0,04	0,05	0,07
S	Ni-based	20	0,005	0,010	0,013	0,019	0,02	0,03	0,04	30	0,007	0,014	0,019	0,027	0,03	0,04	0,05
	Ti-based	35	0,007	0,014	0,019	0,027	0,03	0,04	0,05	55	0,010	0,020	0,027	0,038	0,05	0,06	0,08



Ratio end mills RF 100 VA

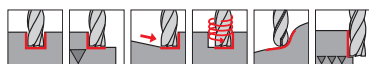
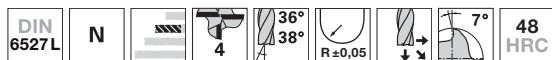

P	•	GUHRING NAVIGATOR Cutting data page 328
M	•	
K	○	
N	•	
S	•	
H	○	

• neck clearance
• centre cutting

Tool material	Solid carbide	
Surface	a	a
Type	N	N
Shank form	HA	HB

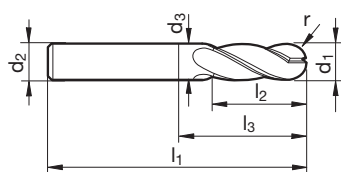

Article no. **6707** **6708**

d1 h10	d2 h6	d3	l1	l2	l3	r	Z	Code no.
mm	mm	mm	mm	mm	mm	mm		
4.00	6.00	3.80	57	11.0	18.0	2.0	4	4.000
5.00	6.00	4.80	57	13.0	18.0	2.5	4	5.000
6.00	6.00	5.70	57	13.0	20.0	3.0	4	6.000
8.00	8.00	7.70	63	19.0	26.0	4.0	4	8.000
10.00	10.00	9.50	72	22.0	30.0	5.0	4	10.000
12.00	12.00	11.50	83	26.0	36.0	6.0	4	12.000
16.00	16.00	15.50	92	32.0	42.0	8.0	4	16.000
20.00	20.00	19.50	104	38.0	52.0	10.0	4	20.000
25.00	25.00	24.00	121	45.0	63.0	12.5	4	25.000

ISO	Hardness	vc	fz (mm/z) / Ø								vc	fz (mm/z) / Ø							
			3	6	8	10	12	16	20	3		6	8	10	12	16	20		
			ap = 0,1 x D				ap = 0,1 x D					ap = 0,01 x D				ap max = 0,01 x D			
P	≤ 850 N/mm ²	240	0,030	0,045	0,060	0,090	0,120	0,150	0,180	390	0,018	0,027	0,036	0,054	0,072	0,090	0,108		
	≥ 850 N/mm ²	200	0,024	0,036	0,048	0,072	0,096	0,120	0,144	320	0,016	0,023	0,031	0,047	0,062	0,078	0,094		
H	≤ 55 HRC	130	0,024	0,036	0,048	0,072	0,096	0,120	0,144	220	0,014	0,022	0,029	0,043	0,058	0,072	0,086		
M	≤ 750 N/mm ²	160	0,026	0,039	0,052	0,078	0,104	0,130	0,156	260	0,016	0,023	0,031	0,047	0,062	0,078	0,094		
	≥ 750 N/mm ²	80	0,020	0,030	0,040	0,060	0,080	0,100	0,120	140	0,012	0,018	0,024	0,036	0,048	0,060	0,072		
S	Ni-based	45	0,020	0,030	0,040	0,060	0,080	0,100	0,120	80	0,012	0,018	0,024	0,036	0,048	0,060	0,072		
	Ti-based	100	0,024	0,036	0,048	0,072	0,096	0,120	0,144	170	0,014	0,022	0,029	0,043	0,058	0,072	0,086		
K	≤ 240 HB	220	0,030	0,045	0,060	0,090	0,120	0,150	0,180	360	0,018	0,027	0,036	0,054	0,072	0,090	0,108		
	≥ 240 HB	180	0,026	0,039	0,052	0,078	0,104	0,130	0,156	300	0,016	0,023	0,031	0,047	0,062	0,078	0,094		
N	≥ 7 % Si	300	0,030	0,045	0,060	0,090	0,120	0,150	0,180	500	0,018	0,027	0,036	0,054	0,072	0,090	0,108		

Stainless steel and difficult-to-machine alloys

Ratio end mills RF 100 VA

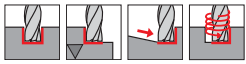

P • **GUHRING NAVIGATOR**
M • Cutting data page 328
K •
N ○
S ○
H • neck clearance
 • centre cutting

Stainless steel and difficult-to-machine alloys

Tool material	Solid carbide	
Surface	a	a
Type	NF	NF
Shank form	HA	HB
	NEW	NEW

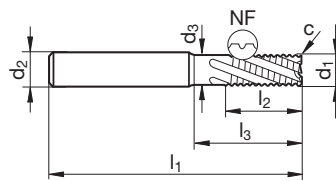

Article no. **6877** **6878**

d1 h10	d2 h6	d3	l1	l2	l3	c	Z	Code no.
mm	mm	mm	mm	mm	mm	mm x 45°		
5.00	6.00	4.80	57	13.0	18.0	0.10	4	5.000
6.00	6.00	5.70	57	13.0	20.0	0.12	4	6.000
7.00	8.00	6.70	63	16.0	24.9	0.14	4	7.000
8.00	8.00	7.70	63	19.0	26.0	0.16	4	8.000
9.00	10.00	8.70	72	19.0	29.9	0.18	4	9.000
10.00	10.00	9.50	72	22.0	30.0	0.20	4	10.000
12.00	12.00	11.50	83	26.0	36.0	0.24	4	12.000
14.00	14.00	13.50	83	26.0	36.0	0.28	4	14.000
16.00	16.00	15.50	92	32.0	42.0	0.32	4	16.000
18.00	18.00	17.50	92	32.0	42.0	0.36	4	18.000
20.00	20.00	19.50	104	38.0	52.0	0.40	4	20.000
25.00	25.00	24.00	121	45.0	63.0	0.50	4	25.000

ISO	Hardness	vc	fz (mm/z) / Ø							vc	fz (mm/z) / Ø							
			3	6	8	10	12	16	20		3	6	8	10	12	16	20	
P	≤ 850 N/mm ²	135	0,009	0,018	0,024	0,032	0,038	0,051	0,064		160	0,010	0,021	0,028	0,037	0,044	0,059	0,074
	≥ 850 N/mm ²	100	0,008	0,017	0,022	0,030	0,036	0,048	0,060			120	0,010	0,019	0,026	0,035	0,041	0,055
M	≤ 750 N/mm ²	90	0,008	0,017	0,022	0,030	0,036	0,048	0,060		110	0,010	0,019	0,026	0,035	0,041	0,055	0,069
	≥ 750 N/mm ²	55	0,007	0,013	0,018	0,025	0,030	0,040	0,050			70	0,008	0,016	0,021	0,030	0,036	0,048
S	Ni-based	25	0,006	0,012	0,016	0,022	0,026	0,035	0,044		40	0,007	0,014	0,019	0,026	0,032	0,042	0,053
	Ti-based	50	0,007	0,013	0,018	0,025	0,030	0,040	0,050			70	0,008	0,016	0,021	0,030	0,036	0,048
K	≤ 240 HB	120	0,009	0,018	0,024	0,032	0,038	0,051	0,064		140	0,010	0,021	0,028	0,037	0,044	0,059	0,074
	≥ 240 HB	105	0,008	0,017	0,022	0,030	0,036	0,048	0,060			130	0,010	0,019	0,026	0,035	0,041	0,055



Ratio end mills RF 100 VA

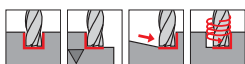

GUHRING NAVIGATOR
Cutting data page 328

- P** •
- M** •
- K** •
- N** ○
- S** ○
- H** □

- neck clearance
- centre cutting

Tool material	Solid carbide	
Surface	a	a
Type	NF	NF
Shank form	HA	HB
	NEW	NEW

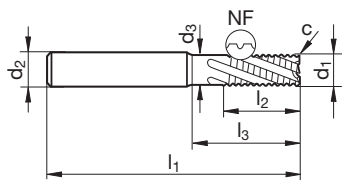

Stainless steel and difficult-to-machine alloys

Article no. **6879** **6880**

d1 h10	d2 h6	d3	l1	l2	l3	c	Z	Code no.
mm	mm	mm	mm	mm	mm	mm x 45°		
6.00	6.00	5.70	65	10.0	28.0	0.12	4	6.000
8.00	8.00	7.70	75	12.0	38.0	0.16	4	8.000
10.00	10.00	9.50	80	14.0	38.0	0.20	4	10.000
12.00	12.00	11.50	93	16.0	46.0	0.24	4	12.000
16.00	16.00	15.50	108	22.0	58.0	0.32	4	16.000
20.00	20.00	19.50	126	26.0	74.0	0.40	4	20.000

ISO	Hardness	vc	fz (mm/z) / Ø							vc	fz (mm/z) / Ø						
			3	6	8	10	12	16	20		3	6	8	10	12	16	20
			ap = 1,0 x D								ap = 1,0 x D			ae max = 0,75 x D			
P	≤ 850 N/mm ²	80	0,005	0,011	0,014	0,019	0,023	0,031	0,038	110	0,007	0,014	0,019	0,026	0,031	0,041	0,052
	≥ 850 N/mm ²	60	0,005	0,010	0,013	0,018	0,022	0,029	0,036	85	0,007	0,014	0,018	0,024	0,029	0,039	0,048
M	≤ 750 N/mm ²	55	0,005	0,010	0,013	0,018	0,022	0,029	0,036	75	0,007	0,014	0,018	0,024	0,029	0,039	0,048
	≥ 750 N/mm ²	35	0,004	0,008	0,011	0,015	0,018	0,024	0,030	50	0,006	0,011	0,015	0,021	0,025	0,034	0,042
S	Ni-based	15	0,004	0,007	0,010	0,013	0,016	0,021	0,026	30	0,005	0,010	0,013	0,018	0,022	0,030	0,037
	Ti-based	30	0,004	0,008	0,011	0,015	0,018	0,024	0,030	50	0,006	0,011	0,015	0,021	0,025	0,034	0,042
K	≤ 240 HB	70	0,005	0,011	0,014	0,019	0,023	0,031	0,038	100	0,007	0,014	0,019	0,026	0,031	0,041	0,052
	≥ 240 HB	65	0,005	0,010	0,013	0,018	0,022	0,029	0,036	90	0,007	0,014	0,018	0,024	0,029	0,039	0,048

RF 100 P – Pilot cutter

Piloting, drilling, finishing - with only one tool

Ratio[®]



very good guide characteristics
thanks to special support chamfer



unequal cutting edge distribution
for optimal smooth running

Summary of advantages:

- ▶ Piloting, drilling and finishing with only one tool
- ▶ Piloting and finishing particularly on inclined surfaces
- ▶ For widening holes
- ▶ Ramping up to a 45° plunging angle
- ▶ Drilling on curved surfaces and off-centre

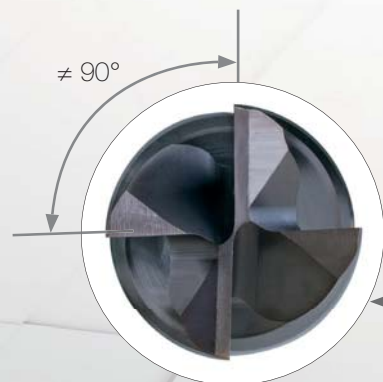

Detailed pilot geometry
with reinforced flutes and greater
chip space for drilling and ramping
operations



Pilot end mills RF 100 P

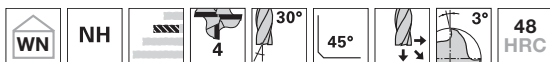

P • **GUHRING NAVIGATOR**
M ○ Cutting data page 335
K •
N •
S ○ • for piloting, drilling, finishing
H ○ • special pilot geometry
 • centre cutting

Tool material	Solid carbide
Surface	A
Type	NH
Shank form	HA

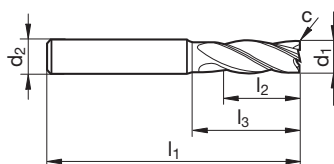

Article no. **6716**

d1 m8	d2 h6	l1	l2	l3	c	Z	Code no.
mm	mm	mm	mm	mm	mm x 45°		
1.40	3.00	38	3.0	5.9	0.01	4	1.400
1.50	3.00	38	4.0	6.9	0.02	4	1.500
1.80	3.00	38	6.0	8.9	0.02	4	1.800
2.00	3.00	38	6.5	9.4	0.02	4	2.000
2.10	3.00	38	6.5	9.9	0.02	4	2.100
2.30	3.00	38	6.5	9.9	0.02	4	2.300
2.50	3.00	38	6.5	9.9	0.03	4	2.500
2.80	3.00	38	6.5	10.0	0.03	4	2.800
3.00	6.00	57	8.0	12.4	0.03	4	3.000
3.50	6.00	57	10.0	14.9	0.04	4	3.500
4.00	6.00	57	11.0	15.9	0.04	4	4.000
4.50	6.00	57	11.0	17.4	0.05	4	4.500
5.00	6.00	57	13.0	19.4	0.05	4	5.000
5.50	6.00	57	13.0	20.4	0.06	4	5.500
6.00	8.00	63	13.0	20.4	0.06	4	6.000
6.50	8.00	63	13.0	20.9	0.07	4	6.500
7.00	8.00	63	16.0	23.9	0.07	4	7.000
7.50	8.00	63	16.0	23.9	0.08	4	7.500
8.00	10.00	72	19.0	26.9	0.08	4	8.000
8.50	10.00	72	19.0	28.4	0.09	4	8.500
9.00	10.00	72	19.0	28.4	0.09	4	9.000
10.00	12.00	83	22.0	31.4	0.10	4	10.000
11.00	12.00	83	26.0	36.4	0.11	4	11.000
12.00	14.00	83	26.0	37.4	0.12	4	12.000

ISO	Hardness	vc	fz (mm/z) / Ø							vc	fz (mm/z) / Ø						
			Drilling			ap = 1 x D ae = 1 x D					Grooving			ap = l2 ae = 1 x D			
			3	6	8	10	12	16	20		3	6	8	10	12	16	20
P	≤ 850 N/mm ²	135	0,008	0,016	0,021	0,030	0,036	0,048	0,060	180	0,016	0,031	0,042	0,060	0,07	0,10	0,12
	≥ 850 N/mm ²	100	0,007	0,014	0,018	0,025	0,030	0,040	0,050	135	0,014	0,027	0,036	0,050	0,06	0,08	0,10
M	≤ 750 N/mm ²	90	0,007	0,014	0,018	0,025	0,030	0,040	0,050	120	0,014	0,027	0,036	0,050	0,06	0,08	0,10
	≥ 750 N/mm ²	45	0,005	0,011	0,014	0,020	0,024	0,032	0,040	60	0,011	0,021	0,028	0,040	0,05	0,06	0,08
S	Ni-based	25	0,004	0,008	0,011	0,016	0,019	0,026	0,032	30	0,008	0,017	0,022	0,032	0,04	0,05	0,06
	Ti-based	45	0,006	0,012	0,016	0,023	0,027	0,036	0,045	60	0,012	0,024	0,032	0,045	0,05	0,07	0,09
K	≤ 240 HB	120	0,008	0,017	0,022	0,033	0,039	0,052	0,065	160	0,017	0,033	0,044	0,065	0,08	0,10	0,13
	≥ 240 HB	105	0,008	0,015	0,020	0,028	0,033	0,044	0,055	140	0,015	0,030	0,040	0,055	0,07	0,09	0,11
N	≤ 7 % Si	375	0,010	0,020	0,026	0,040	0,048	0,064	0,080	500	0,020	0,039	0,052	0,080	0,10	0,13	0,16
	≥ 7 % Si	175	0,008	0,017	0,022	0,030	0,036	0,048	0,060	230	0,017	0,033	0,044	0,060	0,07	0,10	0,12

Stainless steel and difficult-to-machine alloys

Ratio end mills RF 100 DIVER (3-fluted)

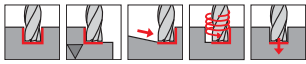

P • **GUHRING NAVIGATOR**

M • Cutting data page 326

K •

N •

S •

H •

- neck clearance
- centre cutting
- with special drill face

Tool material

Solid carbide

Surface

Y

Y

Type

NH

NH

Shank form

HA

HB



Stainless steel and difficult-to-machine alloys

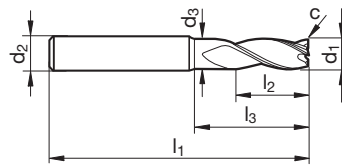

Article no.

6797

6798

d1 h10	d2 h6	d3	l1	l2	l3	c	Z	Code no.
mm	mm	mm	mm	mm	mm	mm x 45°		
3.00	6.00	2.80	57	8.0	15.0	0.05	3	3.000
3.50	6.00	3.30	57	10.0	15.0	0.05	3	3.500
3.70	6.00	3.50	57	11.0	15.0	0.06	3	3.700
4.00	6.00	3.80	57	11.0	18.0	0.06	3	4.000
4.50	6.00	4.30	57	11.0	18.0	0.07	3	4.500
4.70	6.00	4.50	57	13.0	18.0	0.07	3	4.700
5.00	6.00	4.80	57	13.0	18.0	0.08	3	5.000
5.50	6.00	5.30	57	13.0	19.4	0.08	3	5.500
5.70	6.00	5.50	57	13.0	19.6	0.09	3	5.700
6.00	6.00	5.70	57	13.0	20.0	0.09	3	6.000
6.50	8.00	6.20	63	16.0	24.4	0.10	3	6.500
7.00	8.00	6.70	63	16.0	24.9	0.11	3	7.000
7.50	8.00	7.20	63	19.0	25.3	0.11	3	7.500
8.00	8.00	7.70	63	19.0	26.0	0.12	3	8.000
8.50	10.00	8.20	72	19.0	29.4	0.13	3	8.500
9.00	10.00	8.70	72	19.0	29.9	0.14	3	9.000
9.50	10.00	9.20	72	22.0	30.3	0.14	3	9.500
10.00	10.00	9.50	72	22.0	30.0	0.15	3	10.000
12.00	12.00	11.50	83	26.0	36.0	0.18	3	12.000
16.00	16.00	15.50	92	32.0	42.0	0.19	3	16.000
20.00	20.00	19.50	104	38.0	52.0	0.24	3	20.000

ISO	Hardness	vc	fz (mm/z) / Ø							vc	fz (mm/z) / Ø						
			3	6	8	10	12	16	20		3	6	8	10	12	16	20
P	≤ 850 N/mm ²	270	0,017	0,025	0,034	0,050	0,060	0,080	0,100	350	0,021	0,032	0,042	0,063	0,075	0,100	0,125
	≥ 850 N/mm ²	180	0,014	0,021	0,028	0,045	0,054	0,072	0,090	260	0,018	0,027	0,036	0,059	0,070	0,094	0,117
M	≤ 750 N/mm ²	120	0,014	0,021	0,028	0,045	0,054	0,072	0,090	160	0,018	0,027	0,036	0,059	0,070	0,094	0,117
	≥ 750 N/mm ²	80	0,013	0,019	0,026	0,040	0,048	0,064	0,080	120	0,019	0,029	0,038	0,060	0,072	0,096	0,120
S	Ti-based	60	0,013	0,019	0,026	0,040	0,048	0,064	0,080	110	0,017	0,025	0,033	0,052	0,062	0,083	0,104
K	≤ 240 HB	150	0,017	0,025	0,034	0,050	0,060	0,080	0,100	190	0,021	0,032	0,042	0,063	0,075	0,100	0,125
N	≥ 7% Si	340	0,018	0,027	0,036	0,055	0,066	0,088	0,110	440	0,023	0,034	0,045	0,069	0,083	0,110	0,138



Ratio end mills RF 100 DIVER (3-fluted)

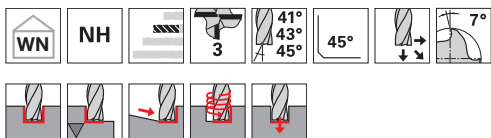

- P** •
- M** •
- K** •
- N** •
- S** •
- H** •

GUHRING NAVIGATOR

Cutting data page 326

- with internal cooling: Radial and axial exits
- neck clearance
- centre cutting
- with special drill face

Tool material	Solid carbide	
Surface	Y	Y
Type	NH	NH
Shank form	HA	HB

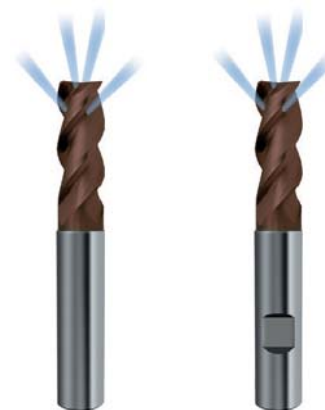
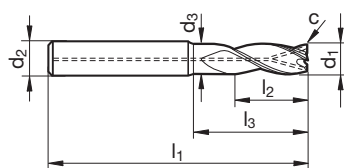

Stainless steel and difficult-to-machine alloys

Article no. **6799** **6800**

d1 h10	d2 h6	d3	l1	l2	l3	c	Z	Code no.
mm	mm	mm	mm	mm	mm	mm x 45°		
6.00	6.00	5.70	57	13.0	20.0	0.09	3	6.000
8.00	8.00	7.70	63	19.0	26.0	0.12	3	8.000
10.00	10.00	9.50	72	22.0	30.0	0.15	3	10.000
12.00	12.00	11.50	83	26.0	36.0	0.18	3	12.000
16.00	16.00	15.50	92	32.0	42.0	0.19	3	16.000

ISO	Hardness	vc	fz (mm/z) / Ø							vc	fz (mm/z) / Ø						
			4	6	8	10	12	16	20		4	6	8	10	12	16	20
P	≤ 850 N/mm ²	270	0,017	0,025	0,034	0,050	0,060	0,080	0,100	270	0,014	0,021	0,028	0,040	0,048	0,064	0,080
	≥ 850 N/mm ²	180	0,014	0,021	0,028	0,045	0,054	0,072	0,090	180	0,008	0,012	0,016	0,025	0,030	0,040	0,050
M	≤ 750 N/mm ²	120	0,014	0,021	0,028	0,045	0,054	0,072	0,090	90	0,007	0,011	0,014	0,023	0,027	0,036	0,045
	≥ 750 N/mm ²	80	0,013	0,019	0,026	0,040	0,048	0,064	0,080	60	0,006	0,010	0,013	0,020	0,024	0,032	0,040
S	Ti-based	60	0,013	0,019	0,026	0,040	0,048	0,064	0,080	50	0,006	0,010	0,013	0,020	0,024	0,032	0,040
K	≤ 240 HB	150	0,017	0,025	0,034	0,050	0,060	0,080	0,100	150	0,014	0,021	0,028	0,040	0,048	0,064	0,080
N	≥ 7% Si	340	0,018	0,027	0,036	0,055	0,066	0,088	0,110	340	0,014	0,021	0,028	0,040	0,048	0,064	0,080

Ratio end mills RF 100 DIVER

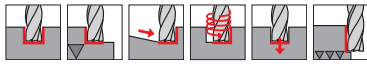

P • **GUHRING NAVIGATOR**

M • Cutting data page 326

K •

N •

S •

H ○ • neck clearance
• centre cutting

Tool material	Solid carbide	
Surface	Y	Y
Type	N	N
Shank form	HA	HB



Stainless steel and difficult-to-machine alloys

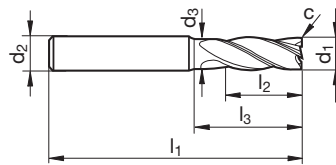

Article no. **6803** **6804**

d1 h10	d2 h6	d3	l1	l2	l3	c	Z	Code no.
mm	mm	mm	mm	mm	mm	mm x 45°		
3.00	6.00	2.80	50	5.0	12.0	0.03	4	3.000
3.70	6.00	3.50	54	8.0	12.0	0.04	4	3.700
4.00	6.00	3.80	54	8.0	15.0	0.04	4	4.000
4.70	6.00	4.50	54	9.0	15.0	0.05	4	4.700
5.00	6.00	4.80	54	9.0	15.0	0.05	4	5.000
5.70	6.00	5.50	54	10.0	16.6	0.06	4	5.700
6.00	6.00	5.70	54	10.0	17.0	0.06	4	6.000
7.00	8.00	6.70	58	11.0	19.9	0.07	4	7.000
7.70	8.00	7.40	58	12.0	20.5	0.08	4	7.700
8.00	8.00	7.70	58	12.0	21.0	0.08	4	8.000
9.00	10.00	8.70	66	13.0	23.9	0.09	4	9.000
9.70	10.00	9.40	66	14.0	24.5	0.10	4	9.700
10.00	10.00	9.50	66	14.0	24.0	0.10	4	10.000
11.70	12.00	11.20	73	16.0	25.3	0.12	4	11.700
12.00	12.00	11.50	73	16.0	26.0	0.12	4	12.000
15.60	16.00	15.10	82	22.0	31.2	0.16	4	15.600
16.00	16.00	15.50	82	22.0	32.0	0.16	4	16.000
19.00	20.00	18.50	92	26.0	38.7	0.19	4	19.000
20.00	20.00	19.50	92	26.0	40.0	0.20	4	20.000

ISO	Hardness	vc	fz (mm/z) / Ø						vc	fz (mm/z) / Ø							
			3	6	8	10	12	16		20	3	6	8	10	12	16	20
P	≤ 850 N/mm ²	270	0,017	0,025	0,034	0,050	0,060	0,080	0,100	450	0,027	0,040	0,054	0,080	0,10	0,13	0,16
	≥ 850 N/mm ²	180	0,014	0,021	0,028	0,045	0,054	0,072	0,090	300	0,022	0,034	0,045	0,072	0,09	0,12	0,14
M	≤ 750 N/mm ²	120	0,014	0,021	0,028	0,045	0,054	0,072	0,090	200	0,022	0,034	0,045	0,072	0,09	0,12	0,14
	≥ 750 N/mm ²	80	0,013	0,019	0,026	0,040	0,048	0,064	0,080	140	0,020	0,031	0,041	0,064	0,08	0,10	0,13
S	Ti-based	60	0,013	0,019	0,026	0,040	0,048	0,064	0,080	110	0,020	0,031	0,041	0,064	0,08	0,10	0,13
K	≤ 240 HB	150	0,017	0,025	0,034	0,050	0,060	0,080	0,100	250	0,027	0,040	0,054	0,080	0,10	0,13	0,16
N	≥ 7% Si	340	0,018	0,027	0,036	0,055	0,066	0,088	0,110	570	0,029	0,043	0,058	0,088	0,11	0,14	0,18



Ratio end mills RF 100 DIVER

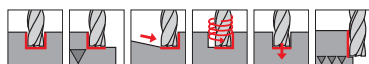

- P** • **GUHRING NAVIGATOR**
- M** • Cutting data page 326
- K** •
- N** •
- S** •
- H** ○
 - neck clearance
 - centre cutting

Tool material	Solid carbide	
Surface	Y	Y
Type	NH	NH
Shank form	HA	HB

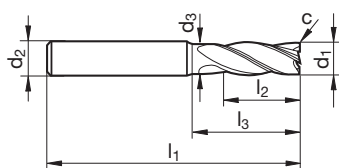

Article no. **6737** **6736**

d1 h10	d2 h6	d3	l1	l2	l3	c	Z	Code no.
mm	mm	mm	mm	mm	mm	mm x 45°		
4.00	6.00	3.80	57	11.0	18.0	0.04	4	4.000
5.00	6.00	4.80	57	13.0	18.0	0.05	4	5.000
5.70	6.00	5.50	57	13.0	19.6	0.06	4	5.700
6.00	6.00	5.70	57	13.0	20.0	0.06	4	6.000
7.70	8.00	7.40	63	19.0	25.5	0.08	4	7.700
8.00	8.00	7.70	63	19.0	26.0	0.08	4	8.000
9.70	10.00	9.40	72	22.0	30.5	0.10	4	9.700
10.00	10.00	9.50	72	22.0	30.0	0.10	4	10.000
11.70	12.00	11.20	83	26.0	35.3	0.12	4	11.700
12.00	12.00	11.50	83	26.0	36.0	0.12	4	12.000
13.70	14.00	13.20	83	26.0	35.3	0.14	4	13.700
14.00	14.00	13.50	83	26.0	36.0	0.14	4	14.000
15.60	16.00	15.10	92	32.0	41.2	0.16	4	15.600
16.00	16.00	15.50	92	32.0	42.0	0.16	4	16.000
19.50	20.00	19.00	104	38.0	51.1	0.20	4	19.500
20.00	20.00	19.50	104	38.0	52.0	0.20	4	20.000

ISO	Hardness	vc	fz (mm/z) / Ø							vc	fz (mm/z) / Ø											
			3	6	8	10	12	16	20		3	6	8	10	12	16	20					
P	≤ 850 N/mm ²	270	0,017	0,025	0,034	0,050	0,060	0,080	0,100	HPC	ap = l2	ap = 1,0 x D	ae = 1,0 x D	ae max = 0,20 x D	450	0,027	0,040	0,054	0,080	0,10	0,13	0,16
	≥ 850 N/mm ²	180	0,014	0,021	0,028	0,045	0,054	0,072	0,090						300	0,022	0,034	0,045	0,072	0,09	0,12	0,14
M	≤ 750 N/mm ²	120	0,014	0,021	0,028	0,045	0,054	0,072	0,090	HPC	ap = l2	ap = 1,0 x D	ae = 1,0 x D	ae max = 0,20 x D	200	0,022	0,034	0,045	0,072	0,09	0,12	0,14
	≥ 750 N/mm ²	80	0,013	0,019	0,026	0,040	0,048	0,064	0,080						140	0,020	0,031	0,041	0,064	0,08	0,10	0,13
S	Ti-based	60	0,013	0,019	0,026	0,040	0,048	0,064	0,080	HPC	ap = l2	ap = 1,0 x D	ae = 1,0 x D	ae max = 0,20 x D	110	0,020	0,031	0,041	0,064	0,08	0,10	0,13
K	≤ 240 HB	150	0,017	0,025	0,034	0,050	0,060	0,080	0,100	HPC	ap = l2	ap = 1,0 x D	ae = 1,0 x D	ae max = 0,20 x D	250	0,027	0,040	0,054	0,080	0,10	0,13	0,16
N	≥ 7% Si	340	0,018	0,027	0,036	0,055	0,066	0,088	0,110	HPC	ap = l2	ap = 1,0 x D	ae = 1,0 x D	ae max = 0,20 x D	570	0,029	0,043	0,058	0,088	0,11	0,14	0,18

Stainless steel and difficult-to-machine alloys

Ratio end mills RF 100 DIVER

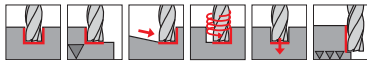

P • **GUHRING NAVIGATOR**

M • Cutting data page 326

- K** •
- N** •
- S** •
- H** ○

- with internal cooling: Radial and axial exits
- neck clearance
- centre cutting

Tool material	Solid carbide	
Surface	Y	Y
Type	N	N
Shank form	HA	HB



Stainless steel and difficult-to-machine alloys

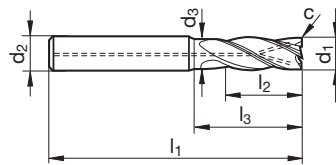

Article no. **6801** **6802**

d1 h10	d2 h6	d3	l1	l2	l3	c	Z	Code no.
mm	mm	mm	mm	mm	mm	mm x 45°		
6.00	6.00	5.70	57	13.0	20.0	0.06	4	6.000
8.00	8.00	7.70	63	19.0	26.0	0.08	4	8.000
10.00	10.00	9.50	72	22.0	30.0	0.10	4	10.000
12.00	12.00	11.50	83	26.0	36.0	0.12	4	12.000
16.00	16.00	15.50	92	32.0	42.0	0.16	4	16.000
20.00	20.00	19.50	104	38.0	52.0	0.20	4	20.000
25.00	25.00	24.00	121	45.0	63.0	0.25	4	25.000

ISO	Hardness	vc	fz (mm/z) / Ø							vc	fz (mm/z) / Ø						
			3	6	8	10	12	16	20		3	6	8	10	12	16	20
P	≤ 850 N/mm ²	270	0,017	0,025	0,034	0,050	0,060	0,080	0,100	450	0,027	0,040	0,054	0,080	0,10	0,13	0,16
	≥ 850 N/mm ²	180	0,014	0,021	0,028	0,045	0,054	0,072	0,090	300	0,022	0,034	0,045	0,072	0,09	0,12	0,14
M	≤ 750 N/mm ²	120	0,014	0,021	0,028	0,045	0,054	0,072	0,090	200	0,022	0,034	0,045	0,072	0,09	0,12	0,14
	≥ 750 N/mm ²	80	0,013	0,019	0,026	0,040	0,048	0,064	0,080	140	0,020	0,031	0,041	0,064	0,08	0,10	0,13
S	Ti-based	60	0,013	0,019	0,026	0,040	0,048	0,064	0,080	110	0,020	0,031	0,041	0,064	0,08	0,10	0,13
K	≤ 240 HB	150	0,017	0,025	0,034	0,050	0,060	0,080	0,100	250	0,027	0,040	0,054	0,080	0,10	0,13	0,16
N	≥ 7% Si	340	0,018	0,027	0,036	0,055	0,066	0,088	0,110	570	0,029	0,043	0,058	0,088	0,11	0,14	0,18



Ratio end mills RF 100 F

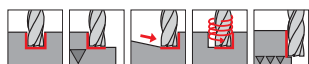

GUHRING NAVIGATOR
Cutting data page 328

P	•
M	•
K	
N	○
S	•
H	

- neck clearance
- centre cutting

Tool material	Solid carbide	
Surface	F	F
Type	NH	NH
Shank form	HA	HB

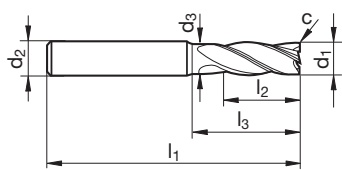

Stainless steel and difficult-to-machine alloys

								Article no.	3629	3630
d1 h10	d2 h6	d3	l1	l2	l3	c	Z	Code no.		
mm	mm	mm	mm	mm	mm	mm x 45°				
4.00	6.00	3.80	57	11.0	18.0	0.10	4	4.000		
5.00	6.00	4.80	57	13.0	18.0	0.10	4	5.000		
6.00	6.00	5.70	57	13.0	20.0	0.15	4	6.000		
8.00	8.00	7.70	63	19.0	26.0	0.15	4	8.000		
10.00	10.00	9.50	72	22.0	30.0	0.20	4	10.000		
12.00	12.00	11.50	83	26.0	36.0	0.20	4	12.000		
16.00	16.00	15.50	92	32.0	42.0	0.35	4	16.000		
20.00	20.00	19.50	104	38.0	52.0	0.45	4	20.000		

ISO	Hardness	vc	fz (mm/z) / Ø								vc	fz (mm/z) / Ø							
			ap = 1,0 x D				ap = 1,0 x D					ap = l2				ap max = 0,2 x D			
			3	6	8	10	12	16	20	3		6	8	10	12	16	20		
P	≤ 850 N/mm ²	180	0,016	0,031	0,042	0,060	0,07	0,10	0,12	305	0,025	0,050	0,067	0,096	0,12	0,15	0,19		
	≥ 850 N/mm ²	135	0,014	0,027	0,036	0,050	0,06	0,08	0,10	230	0,022	0,043	0,058	0,080	0,10	0,13	0,16		
M	≤ 750 N/mm ²	120	0,014	0,027	0,036	0,050	0,06	0,08	0,10	205	0,022	0,043	0,058	0,080	0,10	0,13	0,16		
	≥ 750 N/mm ²	60	0,011	0,021	0,028	0,040	0,05	0,06	0,08	100	0,017	0,034	0,045	0,064	0,08	0,10	0,13		
S	Ni-based	30	0,008	0,017	0,022	0,032	0,04	0,05	0,06	50	0,013	0,027	0,036	0,051	0,06	0,08	0,10		
	Ti-based	60	0,012	0,024	0,032	0,045	0,05	0,07	0,09	100	0,019	0,038	0,051	0,072	0,09	0,12	0,14		

Ratio end mills RF 100 F

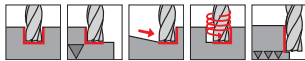

P • **GUHRING NAVIGATOR**

M • Cutting data page 328

K

N ○

S •

H

- with internal coolant supply
- neck clearance
- centre cutting

Tool material **Solid carbide**

Surface **F**

Type **NH**

Shank form **HB**



Stainless steel and difficult-to-machine alloys

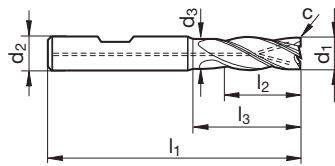

Article no. **3366**

d1 h10	d2 h6	d3	l1	l2	l3	c	Z	Code no.
mm	mm	mm	mm	mm	mm	mm x 45°		
6.00	6.00	5.70	57	13.0	20.0	0.15	4	6.000
8.00	8.00	7.70	63	19.0	26.0	0.15	4	8.000
10.00	10.00	9.50	72	22.0	30.0	0.20	4	10.000
12.00	12.00	11.50	83	26.0	36.0	0.20	4	12.000
16.00	16.00	15.50	92	32.0	42.0	0.35	4	16.000
20.00	20.00	19.50	104	38.0	52.0	0.45	4	20.000

ISO	Hardness	vc	fz (mm/z) / Ø							vc	fz (mm/z) / Ø						
			3	6	8	10	12	16	20		3	6	8	10	12	16	20
P	≤ 850 N/mm ²	180	0,016	0,031	0,042	0,060	0,07	0,10	0,12	305	0,025	0,050	0,067	0,096	0,12	0,15	0,19
	≥ 850 N/mm ²	135	0,014	0,027	0,036	0,050	0,06	0,08	0,10	230	0,022	0,043	0,058	0,080	0,10	0,13	0,16
M	≤ 750 N/mm ²	120	0,014	0,027	0,036	0,050	0,06	0,08	0,10	205	0,022	0,043	0,058	0,080	0,10	0,13	0,16
	≥ 750 N/mm ²	60	0,011	0,021	0,028	0,040	0,05	0,06	0,08	100	0,017	0,034	0,045	0,064	0,08	0,10	0,13
S	Ni-based	30	0,008	0,017	0,022	0,032	0,04	0,05	0,06	50	0,013	0,027	0,036	0,051	0,06	0,08	0,10
	Ti-based	60	0,012	0,024	0,032	0,045	0,05	0,07	0,09	100	0,019	0,038	0,051	0,072	0,09	0,12	0,14



Ratio end mills RF 100 F 90°

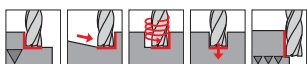

P • **GUHRING NAVIGATOR**
M • Cutting data page 328
K
N ○
S •
H
 • without corner protection chamfer
 • neck clearance
 • centre cutting

Tool material	Solid carbide
Surface	a
Type	NH
Shank form	HA

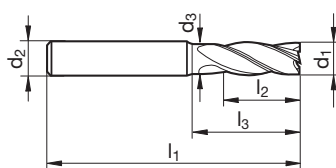

Article no. **6764**

d1 h10	d2 h6	d3	l1	l2	l3	Z	Code no.
mm	mm	mm	mm	mm	mm		
3.00	6.00	2.80	57	8.0	15.0	4	3.000
4.00	6.00	3.80	57	11.0	18.0	4	4.000
5.00	6.00	4.80	57	13.0	18.0	4	5.000
6.00	6.00	5.70	57	13.0	20.0	4	6.000
8.00	8.00	7.70	63	19.0	26.0	4	8.000
10.00	10.00	9.50	72	22.0	30.0	4	10.000
12.00	12.00	11.50	83	26.0	36.0	4	12.000
16.00	16.00	15.50	92	32.0	42.0	4	16.000
20.00	20.00	19.50	104	38.0	52.0	4	20.000

ISO	Hardness	vc	fz (mm/z) / Ø								vc	fz (mm/z) / Ø							
			3	6	8	10	12	16	20	3		6	8	10	12	16	20		
P	≤ 850 N/mm ²	340	0,036	0,072	0,096	0,138	0,17	0,22	0,28	360	0,017	0,034	0,046	0,066	0,08	0,11	0,13		
	≥ 850 N/mm ²	250	0,031	0,062	0,083	0,115	0,14	0,18	0,23	270	0,015	0,030	0,040	0,055	0,07	0,09	0,11		
M	≤ 750 N/mm ²	220	0,031	0,062	0,083	0,115	0,14	0,18	0,23	240	0,015	0,030	0,040	0,055	0,07	0,09	0,11		
	≥ 750 N/mm ²	110	0,024	0,048	0,064	0,092	0,11	0,15	0,18	120	0,011	0,021	0,028	0,040	0,05	0,06	0,08		
S	Ni-based	60	0,019	0,039	0,052	0,074	0,09	0,12	0,15	60	0,008	0,017	0,022	0,032	0,04	0,05	0,06		
	Ti-based	110	0,028	0,055	0,074	0,104	0,12	0,17	0,21	120	0,013	0,026	0,035	0,050	0,06	0,08	0,10		

Stainless steel and difficult-to-machine alloys

RF 100 Speed
HPC milling in steel and VA

RF 100
SPEED

Ratio®



stable cutting edge corner
thanks to corner protection
chamfer and face correction
= **Double Protection!**



optimised chip gullet
deepened flute on front cutting
edge area for improved chip
evacuation

48° helix angle with unequal
cutting edge partitioning for soft,
quiet cut

Chip breaker



**Face geometry with large chip
gullets and improved web thinning
for minimum vibration plunging,
ramping and orbital milling.**



Ratio end mills RF 100 Speed

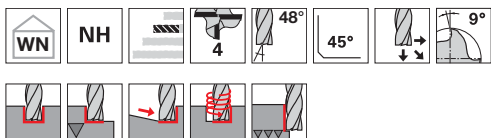

P	•
M	•
K	
N	
S	•
H	

GUHRING NAVIGATOR

Cutting data page 327

- roughing operations of up to max. 0.8xD depth
- re-inforced core from Ø 6 mm
- centre cutting

Tool material	Solid carbide	
Surface	A	A
Type	NH	NH
Shank form	HA	HB

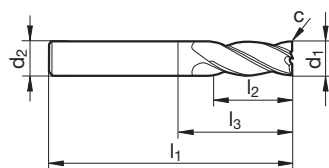

Article no. **6765** **6760**

d1 h10	d2 h6	l1	l2	l3	c	Z	Code no.
mm	mm	mm	mm	mm	mm x 45°		
3.00	6.00	57	8.0	11.4	0.04	4	3.000
4.00	6.00	57	11.0	14.9	0.06	4	4.000
5.00	6.00	57	13.0	16.9	0.07	4	5.000
6.00	6.00	57	15.0	21.0	0.09	4	6.000
8.00	8.00	63	20.0	27.0	0.12	4	8.000
10.00	10.00	72	24.0	32.0	0.15	4	10.000
12.00	12.00	83	28.0	38.0	0.18	4	12.000
16.00	16.00	92	36.0	44.0	0.24	4	16.000
20.00	20.00	104	45.0	54.0	0.30	4	20.000

ISO	Hardness	vc	fz (mm/z) / Ø								vc	fz (mm/z) / Ø							
			3	6	8	10	12	16	20	3		6	8	10	12	16	20		
P	≤ 850 N/mm ²	340	0,036	0,072	0,096	0,138	0,17	0,22	0,28	360	0,017	0,034	0,046	0,066	0,08	0,11	0,13		
	≥ 850 N/mm ²	250	0,031	0,062	0,083	0,115	0,14	0,18	0,23	270	0,015	0,030	0,040	0,055	0,07	0,09	0,11		
M	≤ 750 N/mm ²	220	0,031	0,062	0,083	0,115	0,14	0,18	0,23	240	0,015	0,030	0,040	0,055	0,07	0,09	0,11		
	≥ 750 N/mm ²	110	0,024	0,048	0,064	0,092	0,11	0,15	0,18	120	0,011	0,021	0,028	0,040	0,05	0,06	0,08		
S	Ni-based	60	0,019	0,039	0,052	0,074	0,09	0,12	0,15	60	0,008	0,017	0,022	0,032	0,04	0,05	0,06		
	Ti-based	110	0,028	0,055	0,074	0,104	0,12	0,17	0,21	120	0,013	0,026	0,035	0,050	0,06	0,08	0,10		

Stainless steel and difficult-to-machine alloys

Ratio end mills RF 100 Speed

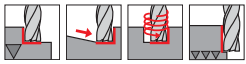

P • **GUHRING NAVIGATOR**

M • Cutting data page 327

K	
N	
S	•
H	

- with chip breaker
- re-inforced core from Ø 6 mm
- centre cutting

Tool material	Solid carbide	
Surface	A	A
Type	NH	NH
Shank form	HA	HB



Stainless steel and difficult-to-machine alloys

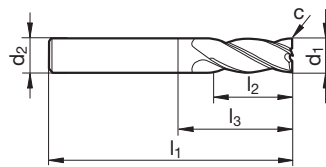

Article no. **6766** **6761**

d1 h10	d2 h6	l1	l2	l3	c	Z	Code no.
mm	mm	mm	mm	mm	mm x 45°		
3.00	6.00	57	12.0	14.9	0.04	4	3.000
4.00	6.00	65	16.0	18.9	0.06	4	4.000
5.00	6.00	65	20.0	22.9	0.07	4	5.000
6.00	6.00	65	24.0	29.0	0.09	4	6.000
8.00	8.00	75	32.0	39.0	0.12	4	8.000
10.00	10.00	90	40.0	50.0	0.15	4	10.000
12.00	12.00	100	46.0	55.0	0.18	4	12.000
16.00	16.00	108	55.0	60.0	0.24	4	16.000
20.00	20.00	126	65.0	76.0	0.30	4	20.000

ISO	Hardness	vc	fz (mm/z) / Ø								vc	fz (mm/z) / Ø																																									
			3		6		8		10			12		16		20		3		6		8		10		12		16		20																							
			ap = l2		HPC		HSC		ae max. = 0,10 x D			ap = l2		ae max. = 0,02 x D		ap = l2		ae max. = 0,02 x D		ap = l2		ae max. = 0,02 x D		ap = l2		ae max. = 0,02 x D		ap = l2		ae max. = 0,02 x D																							
P	≤ 850 N/mm ²	340	0,036	0,072	0,096	0,138	0,17	0,22	0,28	360	0,017	0,034	0,046	0,066	0,08	0,11	0,13	M	≤ 750 N/mm ²	240	0,015	0,030	0,040	0,055	0,07	0,09	0,11	S	Ni-based	60	0,019	0,039	0,052	0,074	0,09	0,12	0,15	60	0,008	0,017	0,022	0,032	0,04	0,05	0,06	120	0,013	0,026	0,035	0,050	0,06	0,08	0,10
	≥ 850 N/mm ²	250	0,031	0,062	0,083	0,115	0,14	0,18	0,23	270	0,015	0,030	0,040	0,055	0,07	0,09	0,11		≥ 750 N/mm ²	110	0,024	0,048	0,064	0,092	0,11	0,15	0,18		Ti-based	110	0,028	0,055	0,074	0,104	0,12	0,17	0,21	120	0,013	0,026	0,035	0,050	0,06	0,08	0,10								

RF 100 Ti - High-performance end mills for special and titanium alloys

Ratio®



optimised corner radius
with NAS contour for long tool life



deeper chip chamber
for good chip evacuation

38°

35°



optimised transition angle
for improved stability



optionally with ZENIT-coating
for even better glide characteristics and
reduced adhesion



**Large face chip pockets and
improved web thinning allow
reliable plunging and orbital
drilling**

RF 100 Ti
AIRCRAFT

Ratio end mills RF 100 Ti

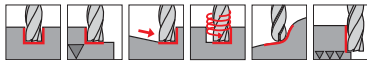

P • **GUHRING NAVIGATOR**

M • Cutting data page 328

- K**
- N**
- S** •
- H** ○

- re-inforced core
- neck clearance
- centre cutting

Tool material	Solid carbide	
Surface	A	A
Type	N	N
Shank form	HA	HB



Stainless steel and difficult-to-machine alloys

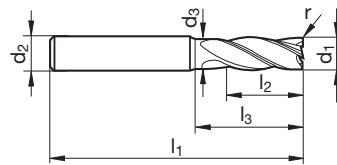



Article no. **3498** **3499**

d1 h10	d2 h6	d3	l1	l2	l3	r	Z	Code no.
mm	mm	mm	mm	mm	mm	mm		
6.00	6.00	5.70	57	13.0	20.0	1.0	4	6.010
6.00	6.00	5.70	57	13.0	20.0	1.5	4	6.015
6.00	6.00	5.70	57	13.0	20.0	0.8	4	6.008
6.00	6.00	5.70	57	13.0	20.0	2.0	4	6.020
6.00	6.00	5.70	57	13.0	20.0	0.5	4	6.005
8.00	8.00	7.70	63	19.0	26.0	0.5	4	8.005
8.00	8.00	7.70	63	19.0	26.0	1.5	4	8.015
8.00	8.00	7.70	63	19.0	26.0	1.0	4	8.010
8.00	8.00	7.70	63	19.0	26.0	2.0	4	8.020
8.00	8.00	7.70	63	19.0	26.0	0.8	4	8.008
10.00	10.00	9.50	72	22.0	30.0	1.0	4	10.010
10.00	10.00	9.50	72	22.0	30.0	1.5	4	10.015
10.00	10.00	9.50	72	22.0	30.0	0.8	4	10.008
10.00	10.00	9.50	72	22.0	30.0	2.0	4	10.020
10.00	10.00	9.50	72	22.0	30.0	0.5	4	10.005
12.00	12.00	11.50	83	26.0	36.0	1.0	4	12.010
12.00	12.00	11.50	83	26.0	36.0	2.5	4	12.025
12.00	12.00	11.50	83	26.0	36.0	2.0	4	12.020
12.00	12.00	11.50	83	26.0	36.0	3.0	4	12.030
12.00	12.00	11.50	83	26.0	36.0	1.5	4	12.015
12.00	12.00	11.50	83	26.0	36.0	3.1	4	12.031
12.00	12.00	11.50	83	26.0	36.0	0.8	4	12.008
12.00	12.00	11.50	83	26.0	36.0	4.0	4	12.040
12.00	12.00	11.50	83	26.0	36.0	0.5	4	12.005
16.00	16.00	15.50	92	32.0	42.0	0.5	4	16.005
16.00	16.00	15.50	92	32.0	42.0	2.5	4	16.025
16.00	16.00	15.50	92	32.0	42.0	2.0	4	16.020
16.00	16.00	15.50	92	32.0	42.0	3.0	4	16.030
16.00	16.00	15.50	92	32.0	42.0	1.5	4	16.015
16.00	16.00	15.50	92	32.0	42.0	3.1	4	16.031
16.00	16.00	15.50	92	32.0	42.0	1.0	4	16.010
16.00	16.00	15.50	92	32.0	42.0	4.0	4	16.040
16.00	16.00	15.50	92	32.0	42.0	0.8	4	16.008
20.00	20.00	19.50	104	38.0	52.0	2.0	4	20.020
20.00	20.00	19.50	104	38.0	52.0	2.5	4	20.025
20.00	20.00	19.50	104	38.0	52.0	3.0	4	20.030



Article no.								3498	3499
d1 h10	d2 h6	d3	l1	l2	l3	r	Z	Code no.	
mm	mm	mm	mm	mm	mm	mm			
20.00	20.00	19.50	104	38.0	52.0	1.5	4	20.015	
20.00	20.00	19.50	104	38.0	52.0	3.1	4	20.031	
20.00	20.00	19.50	104	38.0	52.0	1.0	4	20.010	
20.00	20.00	19.50	104	38.0	52.0	4.0	4	20.040	
20.00	20.00	19.50	104	38.0	52.0	0.5	4	20.005	
25.00	25.00	24.00	121	45.0	63.0	1.5	4	25.015	
25.00	25.00	24.00	121	45.0	63.0	3.1	4	25.031	
25.00	25.00	24.00	121	45.0	63.0	3.0	4	25.030	
25.00	25.00	24.00	121	45.0	63.0	4.0	4	25.040	
25.00	25.00	24.00	121	45.0	63.0	2.5	4	25.025	
25.00	25.00	24.00	121	45.0	63.0	5.0	4	25.050	
25.00	25.00	24.00	121	45.0	63.0	2.0	4	25.020	

Stainless steel and difficult-to-machine alloys

ISO	Hardness	vc	fz (mm/z) / Ø							vc	fz (mm/z) / Ø						
			3	6	8	10	12	16	20		3	6	8	10	12	16	20
			ap = 1,0 x D				ae = 1,0 x D				ap = l2				ae max = 0,2 x D		
P	≤ 850 N/mm ²	180	0,016	0,031	0,042	0,060	0,07	0,10	0,12	305	0,025	0,050	0,067	0,096	0,12	0,15	0,19
	≥ 850 N/mm ²	135	0,014	0,027	0,036	0,050	0,06	0,08	0,10	230	0,022	0,043	0,058	0,080	0,10	0,13	0,16
M	≤ 750 N/mm ²	120	0,014	0,027	0,036	0,050	0,06	0,08	0,10	205	0,022	0,043	0,058	0,080	0,10	0,13	0,16
	≥ 750 N/mm ²	60	0,011	0,021	0,028	0,040	0,05	0,06	0,08	100	0,017	0,034	0,045	0,064	0,08	0,10	0,13
S	Ni-based	30	0,008	0,017	0,022	0,032	0,04	0,05	0,06	50	0,013	0,027	0,036	0,051	0,06	0,08	0,10
	Ti-based	60	0,012	0,024	0,032	0,045	0,05	0,07	0,09	100	0,019	0,038	0,051	0,072	0,09	0,12	0,14

Standard Ratio end mills RF 100 U

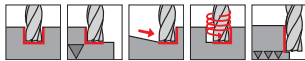
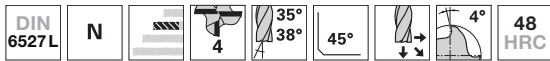

Tool material	Solid carbide
Surface	R
Type	N
Shank form	HB



P • **GUHRING NAVIGATOR**

M ○ Cutting data page 328

K	
N	
S	•
H	○

- Raptor® coating
- neck clearance
- centre cutting

Stainless steel and difficult-to-machine alloys

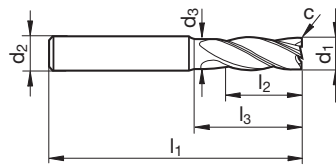

Article no. **6726**

d1 h10	d2 h6	d3	l1	l2	l3	c	Z	Code no.
mm	mm	mm	mm	mm	mm	mm x 45°		
6.00	6.00	5.70	57	13.0	20.0	0.15	4	6.000
8.00	8.00	7.70	63	19.0	26.0	0.15	4	8.000
10.00	10.00	9.50	72	22.0	30.0	0.20	4	10.000
12.00	12.00	11.50	83	26.0	36.0	0.20	4	12.000
16.00	16.00	15.50	92	32.0	42.0	0.35	4	16.000
20.00	20.00	19.50	104	38.0	52.0	0.45	4	20.000

ISO	Hardness	vc	fz (mm/z) / Ø							vc	fz (mm/z) / Ø						
			3	6	8	10	12	16	20		3	6	8	10	12	16	20
P	≤ 850 N/mm ²	340	0,036	0,072	0,096	0,138	0,17	0,22	0,28	360	0,017	0,034	0,046	0,066	0,08	0,11	0,13
	≥ 850 N/mm ²	250	0,031	0,062	0,083	0,115	0,14	0,18	0,23	270	0,015	0,030	0,040	0,055	0,07	0,09	0,11
M	≤ 750 N/mm ²	220	0,031	0,062	0,083	0,115	0,14	0,18	0,23	240	0,015	0,030	0,040	0,055	0,07	0,09	0,11
	≥ 750 N/mm ²	110	0,024	0,048	0,064	0,092	0,11	0,15	0,18	120	0,011	0,021	0,028	0,040	0,05	0,06	0,08
S	Ni-based	60	0,019	0,039	0,052	0,074	0,09	0,12	0,15	60	0,008	0,017	0,022	0,032	0,04	0,05	0,06
	Ti-based	110	0,028	0,055	0,074	0,104	0,12	0,17	0,21	120	0,013	0,026	0,035	0,050	0,06	0,08	0,10



High-performance roughing end mills RS 100 U

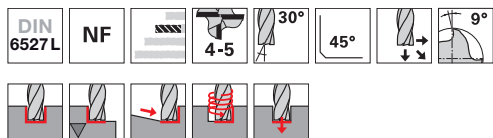

P	•
M	•
K	•
N	○
S	•
H	

GUHRING NAVIGATOR

Cutting data page 329

- neck clearance
- centre cutting

Tool material	Solid carbide	
Surface	F	F
Type	NF	NF
Shank form	HA	HB
	NEW	NEW

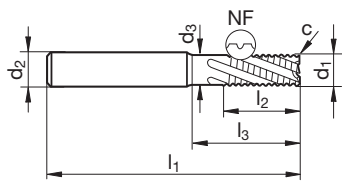

Article no. **6887** **6888**

d1 h10	d2 h6	d3	l1	l2	l3	c	Z	Code no.
mm	mm	mm	mm	mm	mm	mm x 45°		
6.00	6.00	5.70	57	13.0	20.0	0.12	4	6.000
8.00	8.00	7.70	63	19.0	26.0	0.16	4	8.000
10.00	10.00	9.50	72	22.0	30.0	0.20	4	10.000
12.00	12.00	11.50	83	26.0	36.0	0.24	4	12.000
14.00	14.00	13.50	83	26.0	36.0	0.28	4	14.000
16.00	16.00	15.50	92	32.0	42.0	0.32	4	16.000
18.00	18.00	17.50	92	32.0	42.0	0.36	4	18.000
20.00	20.00	19.50	104	38.0	52.0	0.40	4	20.000
25.00	25.00	24.00	121	45.0	63.0	0.60	5	25.000

ISO	Hardness	vc	fz (mm/z) / Ø							vc	fz (mm/z) / Ø						
			3	6	8	10	12	16	20		3	6	8	10	12	16	20
P	≤ 850 N/mm ²	135	0,009	0,018	0,024	0,032	0,038	0,051	0,064	160	0,010	0,021	0,028	0,037	0,044	0,059	0,074
	≥ 850 N/mm ²	100	0,008	0,017	0,022	0,030	0,036	0,048	0,060		120	0,010	0,019	0,026	0,035	0,041	0,055
M	≤ 750 N/mm ²	90	0,008	0,017	0,022	0,030	0,036	0,048	0,060	110	0,010	0,019	0,026	0,035	0,041	0,055	0,069
	≥ 750 N/mm ²	55	0,007	0,013	0,018	0,025	0,030	0,040	0,050		70	0,008	0,016	0,021	0,030	0,036	0,048
S	Ni-based	25	0,006	0,012	0,016	0,022	0,026	0,035	0,044	40	0,007	0,014	0,019	0,026	0,032	0,042	0,053
	Ti-based	50	0,007	0,013	0,018	0,025	0,030	0,040	0,050		70	0,008	0,016	0,021	0,030	0,036	0,048
K	≤ 240 HB	120	0,009	0,018	0,024	0,032	0,038	0,051	0,064	140	0,010	0,021	0,028	0,037	0,044	0,059	0,074
	≥ 240 HB	105	0,008	0,017	0,022	0,030	0,036	0,048	0,060		130	0,010	0,019	0,026	0,035	0,041	0,055

Stainless steel and difficult-to-machine alloys

Roughing end mills GS 100 U (fine teeth)

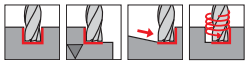

GUHRING NAVIGATOR
Cutting data page 331

- P** •
- M** •
- K** •
- N** ○
- S** ○
- H** ○

• centre cutting

Tool material	Solid carbide	
Surface	○	Ⓡ
Type	NRf	NRf
Shank form	HB	HB

Stainless steel and difficult-to-machine alloys

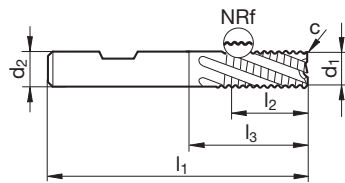

Article no. **3204** **3723**

d1 h10	d2 h6	l1	l2	l3	c	Z	Code no.
mm	mm	mm	mm	mm	mm x 45°		
6.00	6.00	57	13.0	21.0	0.30	4	6.000
8.00	8.00	63	19.0	27.0	0.30	4	8.000
10.00	10.00	72	22.0	32.0	0.30	4	10.000
12.00	12.00	83	26.0	38.0	0.50	4	12.000
14.00	14.00	83	26.0	38.0	0.50	4	14.000
14.00	16.00	92	32.0	42.0	0.50	4	14.001
16.00	16.00	92	32.0	44.0	0.50	4	16.000
18.00	18.00	92	32.0	44.0	0.50	4	18.000
18.00	20.00	104	38.0	53.0	0.50	4	18.001
18.00	20.00	104	38.0	50.0	0.50	4	18.001
20.00	20.00	104	38.0	54.0	0.50	4	20.000
25.00	25.00	121	45.0	65.0	0.60	5	25.000

ISO	Hardness	vc	fz (mm/z) / Ø								vc	fz (mm/z) / Ø							
			ap = 1,0 x D				ap = 1,0 x D					ap = 1,5 x D				ap max = 0,75 x D			
			3	6	8	10	12	16	20	3		6	8	10	12	16	20		
P	≤ 850 N/mm ²	120	0,008	0,017	0,022	0,030	0,036	0,048	0,060	140	0,010	0,019	0,026	0,035	0,041	0,055	0,069		
	≥ 850 N/mm ²	90	0,008	0,015	0,020	0,028	0,034	0,045	0,056	110	0,009	0,017	0,023	0,032	0,039	0,052	0,064		
M	≤ 750 N/mm ²	80	0,008	0,015	0,020	0,028	0,034	0,045	0,056	100	0,009	0,017	0,023	0,032	0,039	0,052	0,064		
	≥ 750 N/mm ²	50	0,006	0,012	0,016	0,022	0,026	0,035	0,044	70	0,007	0,014	0,019	0,026	0,032	0,042	0,053		
S	Ni-based	20	0,005	0,011	0,014	0,020	0,024	0,032	0,040	30	0,006	0,013	0,017	0,024	0,029	0,038	0,048		
	Ti-based	45	0,006	0,012	0,016	0,022	0,026	0,035	0,044	60	0,007	0,014	0,019	0,026	0,032	0,042	0,053		
K	≤ 240 HB	100	0,008	0,017	0,022	0,030	0,036	0,048	0,060	120	0,010	0,019	0,026	0,035	0,041	0,055	0,069		
	≥ 240 HB	90	0,008	0,015	0,020	0,028	0,034	0,045	0,056	110	0,009	0,017	0,023	0,032	0,039	0,052	0,064		

Please reduce cutting values for bright finish tools: vc -50% and fz -25%



Roughing end mills GS 100 U (fine teeth)

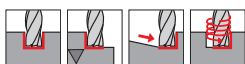

P • **GUHRING NAVIGATOR**
M • Cutting data page 331
K •
N ○
S ○
H □

- with internal coolant supply
- centre cutting

Tool material	Solid carbide
Surface	F
Type	NRf
Shank form	HB

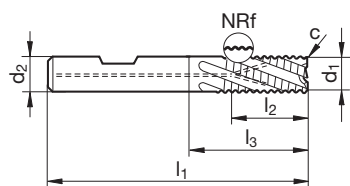

Stainless steel and difficult-to-machine alloys

Article no. **3365**

d1 h10	d2 h6	l1	l2	l3	c	Z	Code no.
mm	mm	mm	mm	mm	mm x 45°		
6.00	6.00	57	13.0	21.0	0.30	4	6.000
8.00	8.00	63	19.0	27.0	0.30	4	8.000
10.00	10.00	72	22.0	32.0	0.30	4	10.000
12.00	12.00	83	26.0	38.0	0.50	4	12.000
16.00	16.00	92	32.0	44.0	0.50	4	16.000
20.00	20.00	104	38.0	54.0	0.50	4	20.000

ISO	Hardness	vc	fz (mm/z) / Ø							vc	fz (mm/z) / Ø						
			3	6	8	10	12	16	20		3	6	8	10	12	16	20
			ap = 1,0 x D								ap = 1,5 x D			ae max = 0,75 x D			
P	≤ 850 N/mm ²	120	0,008	0,017	0,022	0,030	0,036	0,048	0,060	140	0,010	0,019	0,026	0,035	0,041	0,055	0,069
	≥ 850 N/mm ²	90	0,008	0,015	0,020	0,028	0,034	0,045	0,056	110	0,009	0,017	0,023	0,032	0,039	0,052	0,064
M	≤ 750 N/mm ²	80	0,008	0,015	0,020	0,028	0,034	0,045	0,056	100	0,009	0,017	0,023	0,032	0,039	0,052	0,064
	≥ 750 N/mm ²	50	0,006	0,012	0,016	0,022	0,026	0,035	0,044	70	0,007	0,014	0,019	0,026	0,032	0,042	0,053
S	Ni-based	20	0,005	0,011	0,014	0,020	0,024	0,032	0,040	30	0,006	0,013	0,017	0,024	0,029	0,038	0,048
	Ti-based	45	0,006	0,012	0,016	0,022	0,026	0,035	0,044	60	0,007	0,014	0,019	0,026	0,032	0,042	0,053
K	≤ 240 HB	100	0,008	0,017	0,022	0,030	0,036	0,048	0,060	120	0,010	0,019	0,026	0,035	0,041	0,055	0,069
	≥ 240 HB	90	0,008	0,015	0,020	0,028	0,034	0,045	0,056	110	0,009	0,017	0,023	0,032	0,039	0,052	0,064

RF 100 SF – High-performance semi-roughing end mills for materials up to 1600 N/mm² (48 HRC)

Ratio®



optimal smooth running
thanks to Ratio effect with different
helix angles:
44°/45°/46° for fine finishing
and HPC roughing

*i*machining®

highest surface finish quality
thanks to stable radial geometry

perfect stability
with neck clearance
and optimised transition angles

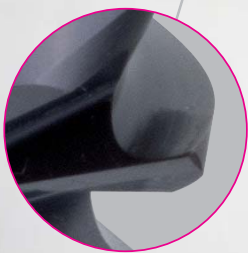

With micro-corner
protection for longer
tool life



Stable face cutting geometry
with reinforced cutting edges and
increased chip spaces for drilling and
ramping operations



Ratio end mills Superfinish RF 100 SF



P • **GUHRING NAVIGATOR**

M • Cutting data page 328

K

N •

S • Raptor® coating

H • neck clearance

• centre cutting

Tool material **Solid carbide**

Surface **R**

Type **NH**

Shank form **HB**

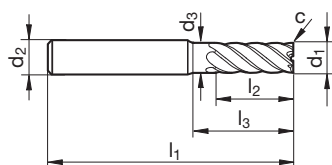

Stainless steel and difficult-to-machine alloys

Article no. **6727**

d1 h10	d2 h6	d3	l1	l2	l3	c	Z	Code no.
mm	mm	mm	mm	mm	mm	mm x 45°		
8.00	8.00	7.70	63	19.0	26.0	0.10	6	8.000
10.00	10.00	9.50	72	22.0	30.0	0.10	6	10.000
12.00	12.00	11.50	83	26.0	36.0	0.10	6	12.000
16.00	16.00	15.50	92	32.0	42.0	0.15	6	16.000
20.00	20.00	19.50	104	38.0	52.0	0.15	6	20.000

ISO	Hardness	vc	fz (mm/z) / Ø							vc	fz (mm/z) / Ø						
			3	6	8	10	12	16	20		3	6	8	10	12	16	20
			ap = l2		HPC	HSC		ae max. = 0,10 x D			ap = l2			ae max. = 0,02 x D			
P	≤ 850 N/mm ²	340	0,036	0,072	0,096	0,138	0,17	0,22	0,28	360	0,017	0,034	0,046	0,066	0,08	0,11	0,13
	≥ 850 N/mm ²	250	0,031	0,062	0,083	0,115	0,14	0,18	0,23	270	0,015	0,030	0,040	0,055	0,07	0,09	0,11
M	≤ 750 N/mm ²	220	0,031	0,062	0,083	0,115	0,14	0,18	0,23	240	0,015	0,030	0,040	0,055	0,07	0,09	0,11
	≥ 750 N/mm ²	110	0,024	0,048	0,064	0,092	0,11	0,15	0,18	120	0,011	0,021	0,028	0,040	0,05	0,06	0,08
S	Ni-based	60	0,019	0,039	0,052	0,074	0,09	0,12	0,15	60	0,008	0,017	0,022	0,032	0,04	0,05	0,06
	Ti-based	110	0,028	0,055	0,074	0,104	0,12	0,17	0,21	120	0,013	0,026	0,035	0,050	0,06	0,08	0,10
N	≤ 7 % Si	900	0,045	0,090	0,120	0,184	0,22	0,29	0,37	1000	0,021	0,043	0,057	0,088	0,11	0,14	0,18
	≥ 7 % Si	430	0,038	0,076	0,101	0,138	0,17	0,22	0,28	460	0,018	0,036	0,048	0,066	0,08	0,11	0,13

Ratio end mills Superfinish RF 100 SF

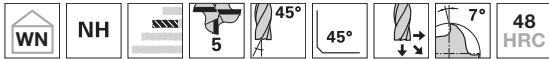

P • **GUHRING NAVIGATOR**

M • Cutting data page 328

- K** •
- N** •
- S** •
- H** ○ • neck clearance
- centre cutting

Tool material	Solid carbide	
Surface	F	F
Type	NH	NH
Shank form	HA	HB



Stainless steel and difficult-to-machine alloys

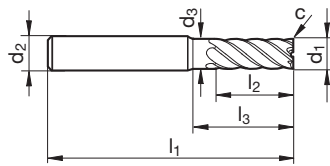

Article no. **6709** **6710**

d1 h10	d2 h6	d3	l1	l2	l3	c	Z	Code no.
mm	mm	mm	mm	mm	mm	mm x 45°		
4.00	6.00	3.80	57	11.0	18.0	0.05	5	4.000
5.00	6.00	4.80	57	13.0	18.0	0.05	5	5.000
6.00	6.00	5.70	57	13.0	20.0	0.05	5	6.000
8.00	8.00	7.70	63	19.0	26.0	0.10	5	8.000
10.00	10.00	9.50	72	22.0	30.0	0.10	5	10.000
12.00	12.00	11.50	83	26.0	36.0	0.10	5	12.000
16.00	16.00	15.50	92	32.0	42.0	0.15	5	16.000
20.00	20.00	19.50	104	38.0	52.0	0.15	5	20.000
25.00	25.00	24.00	121	45.0	63.0	0.20	5	25.000

ISO	Hardness	vc	fz (mm/z) / Ø								vc	fz (mm/z) / Ø							
			3	6	8	10	12	16	20	3		6	8	10	12	16	20		
P	≤ 850 N/mm ²	340	0,036	0,072	0,096	0,138	0,17	0,22	0,28	360	0,017	0,034	0,046	0,066	0,08	0,11	0,13		
	≥ 850 N/mm ²	250	0,031	0,062	0,083	0,115	0,14	0,18	0,23	270	0,015	0,030	0,040	0,055	0,07	0,09	0,11		
M	≤ 750 N/mm ²	220	0,031	0,062	0,083	0,115	0,14	0,18	0,23	240	0,015	0,030	0,040	0,055	0,07	0,09	0,11		
	≥ 750 N/mm ²	110	0,024	0,048	0,064	0,092	0,11	0,15	0,18	120	0,011	0,021	0,028	0,040	0,05	0,06	0,08		
S	Ni-based	60	0,019	0,039	0,052	0,074	0,09	0,12	0,15	60	0,008	0,017	0,022	0,032	0,04	0,05	0,06		
	Ti-based	110	0,028	0,055	0,074	0,104	0,12	0,17	0,21	120	0,013	0,026	0,035	0,050	0,06	0,08	0,10		
K	≤ 240 HB	300	0,038	0,076	0,101	0,150	0,18	0,24	0,30	320	0,018	0,036	0,048	0,072	0,09	0,11	0,14		
	≥ 240 HB	260	0,035	0,069	0,092	0,127	0,15	0,20	0,25	280	0,017	0,033	0,044	0,061	0,07	0,10	0,12		
N	≤ 7 % Si	900	0,045	0,090	0,120	0,184	0,22	0,29	0,37	1000	0,021	0,043	0,057	0,088	0,11	0,14	0,18		
	≥ 7 % Si	430	0,038	0,076	0,101	0,138	0,17	0,22	0,28	460	0,018	0,036	0,048	0,066	0,08	0,11	0,13		



Ratio end mills Superfinish RF 100 SF



P • **GUHRING NAVIGATOR**
M • Cutting data page 328
K •
N •
S •
H ○ • neck clearance
 • centre cutting

Tool material	Solid carbide	
Surface	F	F
Type	NH	NH
Shank form	HA	HB

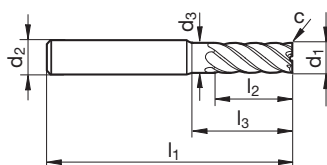

Article no. **3631** **3632**

d1 h10	d2 h6	d3	l1	l2	l3	c	Z	Code no.
mm	mm	mm	mm	mm	mm	mm x 45°		
8.00	8.00	7.70	63	19.0	26.0	0.10	6	8.000
10.00	10.00	9.50	72	22.0	30.0	0.10	6	10.000
12.00	12.00	11.50	83	26.0	36.0	0.10	6	12.000
16.00	16.00	15.50	92	32.0	42.0	0.15	6	16.000
20.00	20.00	19.50	104	38.0	52.0	0.15	6	20.000
25.00	25.00	24.00	121	45.0	63.0	0.20	6	25.000

ISO	Hardness	vc	fz (mm/z) / Ø							vc	fz (mm/z) / Ø						
			3	6	8	10	12	16	20		3	6	8	10	12	16	20
P	≤ 850 N/mm ²	340	0,036	0,072	0,096	0,138	0,17	0,22	0,28	360	0,017	0,034	0,046	0,066	0,08	0,11	0,13
	≥ 850 N/mm ²	250	0,031	0,062	0,083	0,115	0,14	0,18	0,23	270	0,015	0,030	0,040	0,055	0,07	0,09	0,11
M	≤ 750 N/mm ²	220	0,031	0,062	0,083	0,115	0,14	0,18	0,23	240	0,015	0,030	0,040	0,055	0,07	0,09	0,11
	≥ 750 N/mm ²	110	0,024	0,048	0,064	0,092	0,11	0,15	0,18	120	0,011	0,021	0,028	0,040	0,05	0,06	0,08
S	Ni-based	60	0,019	0,039	0,052	0,074	0,09	0,12	0,15	60	0,008	0,017	0,022	0,032	0,04	0,05	0,06
	Ti-based	110	0,028	0,055	0,074	0,104	0,12	0,17	0,21	120	0,013	0,026	0,035	0,050	0,06	0,08	0,10
K	≤ 240 HB	300	0,038	0,076	0,101	0,150	0,18	0,24	0,30	320	0,018	0,036	0,048	0,072	0,09	0,11	0,14
	≥ 240 HB	260	0,035	0,069	0,092	0,127	0,15	0,20	0,25	280	0,017	0,033	0,044	0,061	0,07	0,10	0,12
N	≤ 7 % Si	900	0,045	0,090	0,120	0,184	0,22	0,29	0,37	1000	0,021	0,043	0,057	0,088	0,11	0,14	0,18
	≥ 7 % Si	430	0,038	0,076	0,101	0,138	0,17	0,22	0,28	460	0,018	0,036	0,048	0,066	0,08	0,11	0,13

Stainless steel and difficult-to-machine alloys

Ratio end mills Superfinish RF 100 SF



P • **GUHRING NAVIGATOR**

M • Cutting data page 328

K •

N •

S •

H ○ • neck clearance
• centre cutting

Tool material	Solid carbide	
Surface	F	F
Type	NH	NH
Shank form	HA	HB



Stainless steel and difficult-to-machine alloys

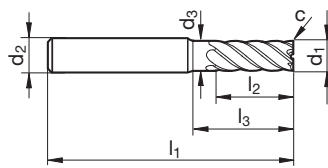

Article no. **3897** **3898**

d1 h10	d2 h6	d3	l1	l2	l3	c	Z	Code no.
mm	mm	mm	mm	mm	mm	mm x 45°		
4.00	6.00	3.80	65	12.0	26.0	0.05	5	4.000
5.00	6.00	4.80	65	15.0	26.0	0.05	5	5.000
6.00	6.00	5.70	65	18.0	28.0	0.05	5	6.000
8.00	8.00	7.70	75	24.0	38.0	0.10	5	8.000
10.00	10.00	9.50	80	30.0	38.0	0.10	5	10.000
12.00	12.00	11.50	93	36.0	46.0	0.10	5	12.000
16.00	16.00	15.50	108	48.0	58.0	0.15	5	16.000
20.00	20.00	19.50	126	60.0	74.0	0.15	5	20.000

ISO	Hardness	vc	fz (mm/z) / Ø								vc	fz (mm/z) / Ø							
			3	6	8	10	12	16	20	3		6	8	10	12	16	20		
P	≤ 850 N/mm ²	340	0,036	0,072	0,096	0,138	0,17	0,22	0,28	360	0,017	0,034	0,046	0,066	0,08	0,11	0,13		
	≥ 850 N/mm ²	250	0,031	0,062	0,083	0,115	0,14	0,18	0,23		270	0,015	0,030	0,040	0,055	0,07	0,09	0,11	
M	≤ 750 N/mm ²	220	0,031	0,062	0,083	0,115	0,14	0,18	0,23	240	0,015	0,030	0,040	0,055	0,07	0,09	0,11		
	≥ 750 N/mm ²	110	0,024	0,048	0,064	0,092	0,11	0,15	0,18		120	0,011	0,021	0,028	0,040	0,05	0,06	0,08	
S	Ni-based	60	0,019	0,039	0,052	0,074	0,09	0,12	0,15	60	0,008	0,017	0,022	0,032	0,04	0,05	0,06		
	Ti-based	110	0,028	0,055	0,074	0,104	0,12	0,17	0,21		120	0,013	0,026	0,035	0,050	0,06	0,08	0,10	
K	≤ 240 HB	300	0,038	0,076	0,101	0,150	0,18	0,24	0,30	320	0,018	0,036	0,048	0,072	0,09	0,11	0,14		
	≥ 240 HB	260	0,035	0,069	0,092	0,127	0,15	0,20	0,25		280	0,017	0,033	0,044	0,061	0,07	0,10	0,12	
N	≤ 7 % Si	900	0,045	0,090	0,120	0,184	0,22	0,29	0,37	1000	0,021	0,043	0,057	0,088	0,11	0,14	0,18		
	≥ 7 % Si	430	0,038	0,076	0,101	0,138	0,17	0,22	0,28		460	0,018	0,036	0,048	0,066	0,08	0,11	0,13	



Ratio end mills Superfinish RF 100 SF 90°



- GUHRING NAVIGATOR**
Cutting data page 328
- P** •
 - M** •
 - K** •
 - N** •
 - S** •
 - H** •
- without corner protection chamfer
 - neck clearance
 - centre cutting

Tool material	Solid carbide
Surface	a
Type	NH
Shank form	HA

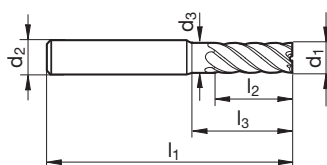

Article no. **6763**

d1 h10	d2 h6	d3	l1	l2	l3	Z	Code no.
mm	mm	mm	mm	mm	mm		
4.00	6.00	3.80	65	12.0	26.0	5	4.000
5.00	6.00	4.80	65	15.0	26.0	5	5.000
6.00	6.00	5.70	65	18.0	28.0	5	6.000
8.00	8.00	7.70	75	24.0	38.0	5	8.000
10.00	10.00	9.50	80	30.0	38.0	5	10.000
12.00	12.00	11.50	93	36.0	46.0	5	12.000
16.00	16.00	15.50	108	48.0	58.0	5	16.000
20.00	20.00	19.50	126	60.0	74.0	5	20.000

ISO	Hardness	vc	fz (mm/z) / Ø								vc	fz (mm/z) / Ø							
			3	6	8	10	12	16	20	3		6	8	10	12	16	20		
			ap = l2		HPC	HSC		ae max. = 0,10 x D				ap = l2			ae max. = 0,02 x D				
P	≤ 850 N/mm ²	340	0,036	0,072	0,096	0,138	0,17	0,22	0,28	360	0,017	0,034	0,046	0,066	0,08	0,11	0,13		
	≥ 850 N/mm ²	250	0,031	0,062	0,083	0,115	0,14	0,18	0,23	270	0,015	0,030	0,040	0,055	0,07	0,09	0,11		
M	≤ 750 N/mm ²	220	0,031	0,062	0,083	0,115	0,14	0,18	0,23	240	0,015	0,030	0,040	0,055	0,07	0,09	0,11		
	≥ 750 N/mm ²	110	0,024	0,048	0,064	0,092	0,11	0,15	0,18	120	0,011	0,021	0,028	0,040	0,05	0,06	0,08		
S	Ni-based	60	0,019	0,039	0,052	0,074	0,09	0,12	0,15	60	0,008	0,017	0,022	0,032	0,04	0,05	0,06		
	Ti-based	110	0,028	0,055	0,074	0,104	0,12	0,17	0,21	120	0,013	0,026	0,035	0,050	0,06	0,08	0,10		
K	≤ 240 HB	300	0,038	0,076	0,101	0,150	0,18	0,24	0,30	320	0,018	0,036	0,048	0,072	0,09	0,11	0,14		
	≥ 240 HB	260	0,035	0,069	0,092	0,127	0,15	0,20	0,25	280	0,017	0,033	0,044	0,061	0,07	0,10	0,12		
N	≤ 7 % Si	900	0,045	0,090	0,120	0,184	0,22	0,29	0,37	1000	0,021	0,043	0,057	0,088	0,11	0,14	0,18		
	≥ 7 % Si	430	0,038	0,076	0,101	0,138	0,17	0,22	0,28	460	0,018	0,036	0,048	0,066	0,08	0,11	0,13		

Stainless steel and difficult-to-machine alloys

Application example

RF 100 A, Ø 20.0 mm

Slot milling in AlMg4.5Mn

$a_e = 20 \text{ mm} / a_p = 11 \text{ mm}$

$v_c = 753 \text{ m/min}$

$f_z = 0.11 \text{ mm}$

$v_f = 7000 \text{ mm/min}$

Metal removal rate $Q = 1540 \text{ cm}^3/\text{min}$

RF 100 A, Ø 16.0 mm

Slot milling in AlMgSi1

$a_e = 7 \text{ mm} / a_p = 30 \text{ mm}$

$v_c = 666 \text{ m/min}$

$f_z = 0.23 \text{ mm}$

$v_f = 9140 \text{ mm/min}$

Metal removal rate $Q = 1919 \text{ cm}^3/\text{min}$

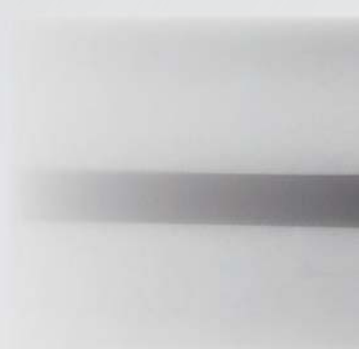

HLINÍK
ALUMINIO
ALUMINIUM
ALUMIN
ALUMINIUM
ALLUMINIO



ALUMINIUM

SOLID CARBIDE HPC HIGH-PERFORMANCE END MILLS

for Aluminium, non-ferrous metals and plastics



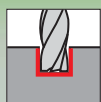

SLOTING

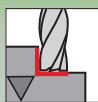

ROUGHING

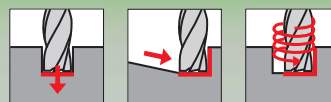

PLUNGING

Aluminium, non-ferrous metals, plastics

No. 1

HPC HSC

N

HPC

N

No. 1

HPC HSC

N

HPC HSC

N

HPC HSC

N

*i*machining a_e up to 0.15xD

HPC

N

a_e up to 0.3xD

No. 1

HPC

N

HPC

N

MTC

N

MTC

N

MTC

N

MTC

N

MTC

N

HPC

N

a_e up to 0.2xD



GÜHRING TROCHOIDAL CUTTING
Dynamic / trochoidal milling



HIGH-PERFORMANCE CUTTING
for max. metal removal rates / time;
rigid conditions, high performance,
good cooling, quick de-clamping



HIGH SPEED CUTTING
with high speeds / high feed rate
low performance, low feed rate



QUICK FINDER

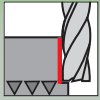

FINISHING

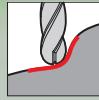

COPYING

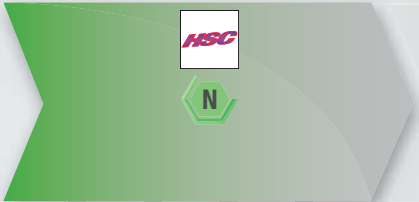

RF100 A Z=3



i.e.: no. 3472 from p. 117

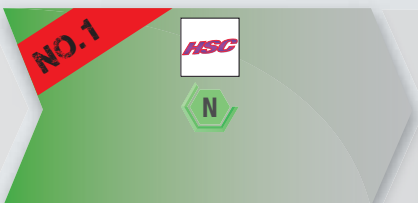
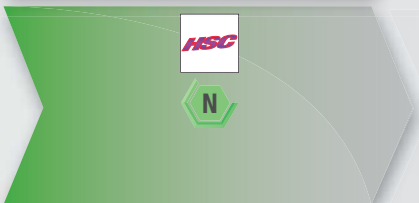

RF100 A Z=3 ER



i.e.: no. 3599 from p. 118

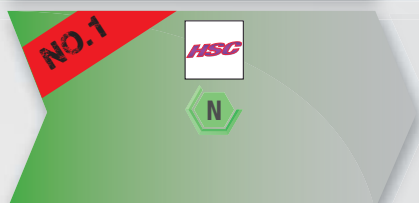

RF100 A Z=3 3xD 4xD 5xD



i.e.: no. 6730 from p. 120

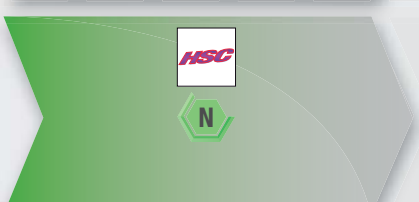

RF100 A Z=4



i.e.: no. 3202 from p. 123

More copying milling cutters from p. 171

RF100 A WF



i.e.: no. 6868 from p. 125

Alu slot drills Z=1 / Z=2



i.e.: no. 3310 from p. 128

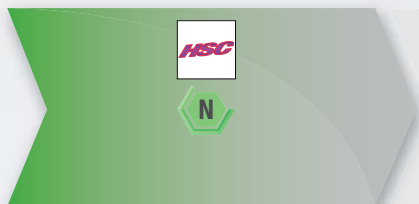

RF100 SF Z=5 / Z=6



i.e.: no. 3631 from p. 134

Aluminium, non-ferrous metals, plastics



MILL TURN CENTER driven tools
non-rigid conditions, low drive power
medium to long de-clamping, moderate cooling



ALUMINIUM, non-ferrous metals & plastics



IDEAL TOOL

EXPLANATIONS
for the Quickfinder see p. 6-7

RF 100 A – High-performance end mills for aluminium and aluminium alloys

Ratio®

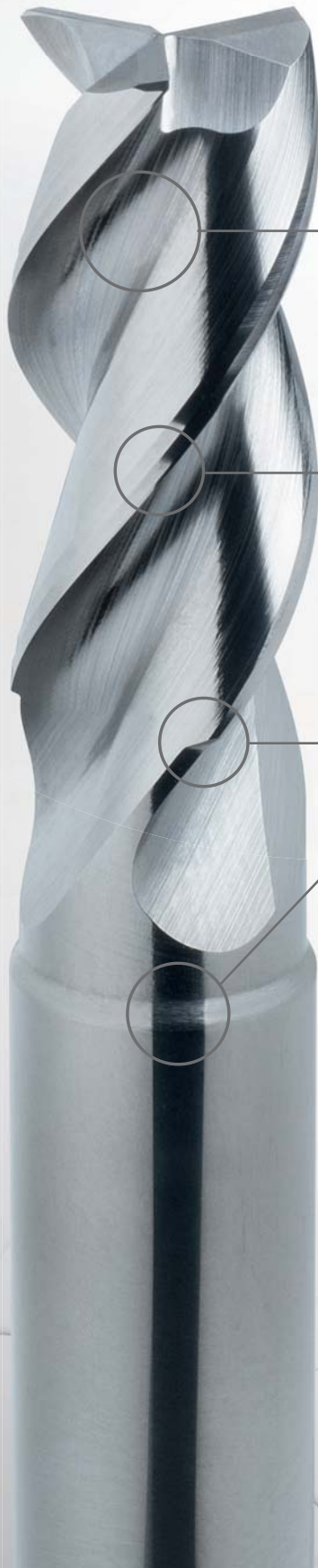

optimal chip evacuation

thanks to large, round chip chambers for slotting and roughing with highest feed rates

optimal surface finishes

low-vibration thanks to nano-polished cutting edges with micro guide chamfers

Maximum stability

thanks to neck clearance with optimised transitions

symmetrical face geometry

with large chip chambers for drilling and ramping operations

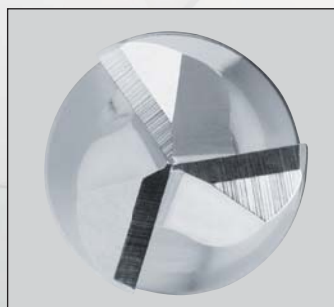



Ratio end mills Alu RF 100 A

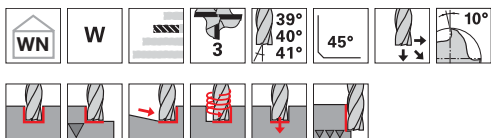

Tool material	Solid carbide	
Surface	○	○
Type	W	W
Shank form	HA	HB

P	
M	
K	
N	•
S	
H	

GUHRING NAVIGATOR

Cutting data page 328

- nano polished cutting edges
- neck clearance
- centre cutting

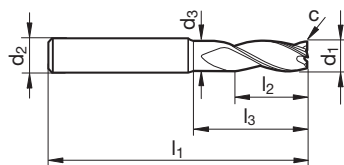

Aluminum, non-ferrous metals and plastics

Article no. **3472** **6702**

d1 h8	d2 h6	d3	l1	l2	l3	c	Z	Code no.
mm	mm	mm	mm	mm	mm	mm x 45°		
3.00	6.00	2.80	57	8.0	15.0	0.03	3	3.000
4.00	6.00	3.80	57	11.0	18.0	0.04	3	4.000
5.00	6.00	4.80	57	13.0	18.0	0.05	3	5.000
6.00	6.00	5.70	57	13.0	20.0	0.06	3	6.000
8.00	8.00	7.70	63	19.0	26.0	0.08	3	8.000
10.00	10.00	9.50	72	22.0	30.0	0.10	3	10.000
12.00	12.00	11.50	83	26.0	36.0	0.12	3	12.000
16.00	16.00	15.50	92	32.0	42.0	0.16	3	16.000
20.00	20.00	19.50	104	38.0	52.0	0.20	3	20.000

ISO	Hardness	vc	fz (mm/z) / Ø							vc	fz (mm/z) / Ø						
			3	6	8	10	12	16	20		3	6	8	10	12	16	20
N	≤ 5% Si	500	0,020	0,039	0,052	0,080	0,10	0,13	0,16	750	0,025	0,051	0,068	0,104	0,12	0,17	0,21
	≥ 5% Si	230	0,017	0,033	0,044	0,060	0,07	0,10	0,12	345	0,021	0,043	0,057	0,078	0,09	0,12	0,16
NE	≤ 850 N/mm ²	250	0,017	0,033	0,044	0,060	0,07	0,10	0,12	375	0,021	0,043	0,057	0,078	0,09	0,12	0,16

Our Carbo-coating is available as an option to improve chip flow and tool life

Ratio end mills Alu RF 100 A

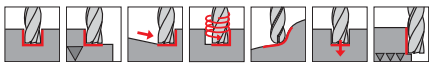

P **GUHRING NAVIGATOR**
 Cutting data page 328

M

K

N •

S

H

- nano polished cutting edges
- neck clearance
- centre cutting

Tool material	Solid carbide	
Surface	○	○
Type	W	W
Shank form	HA	HB

Aluminum, non-ferrous metals and plastics

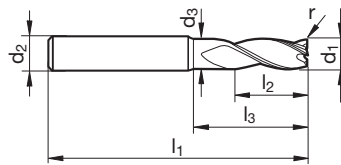

Article no. **3599** **6729**

d1 h8	d2 h6	d3	l1	l2	l3	r	Z	Code no.
mm	mm	mm	mm	mm	mm	mm		
6.00	6.00	5.70	57	13.0	20.0	0.5	3	6.005
6.00	6.00	5.70	57	13.0	20.0	1.0	3	6.010
8.00	8.00	7.70	63	19.0	26.0	0.5	3	8.005
8.00	8.00	7.70	63	19.0	26.0	1.0	3	8.010
10.00	10.00	9.50	72	22.0	30.0	0.5	3	10.005
10.00	10.00	9.50	72	22.0	30.0	1.0	3	10.010
10.00	10.00	9.50	72	22.0	30.0	1.5	3	10.015
12.00	12.00	11.50	83	26.0	36.0	0.5	3	12.005
12.00	12.00	11.50	83	26.0	36.0	1.0	3	12.010
12.00	12.00	11.50	83	26.0	36.0	1.5	3	12.015
12.00	12.00	11.50	83	26.0	36.0	2.0	3	12.020
12.00	12.00	11.50	83	26.0	36.0	2.5	3	12.025
12.00	12.00	11.50	83	26.0	36.0	3.0	3	12.030
12.00	12.00	11.50	83	26.0	36.0	4.0	3	12.040
16.00	16.00	15.50	92	32.0	42.0	1.0	3	16.010
16.00	16.00	15.50	92	32.0	42.0	2.0	3	16.020
16.00	16.00	15.50	92	32.0	42.0	2.5	3	16.025
16.00	16.00	15.50	92	32.0	42.0	3.0	3	16.030
16.00	16.00	15.50	92	32.0	42.0	4.0	3	16.040
20.00	20.00	19.50	104	38.0	52.0	1.0	3	20.010
20.00	20.00	19.50	104	38.0	52.0	2.0	3	20.020
20.00	20.00	19.50	104	38.0	52.0	2.5	3	20.025
20.00	20.00	19.50	104	38.0	52.0	3.0	3	20.030
20.00	20.00	19.50	104	38.0	52.0	4.0	3	20.040
25.00	25.00	24.00	121	45.0	63.0	2.0	3	25.020
25.00	25.00	24.00	121	45.0	63.0	3.0	3	25.030
25.00	25.00	24.00	121	45.0	63.0	4.0	3	25.040

ISO	Hardness	vc	fz (mm/z) / Ø							vc	fz (mm/z) / Ø							
			3	6	8	10	12	16	20		3	6	8	10	12	16	20	
N	≤ 5% Si	500	0,020	0,039	0,052	0,080	0,10	0,13	0,16		750	0,025	0,051	0,068	0,104	0,12	0,17	0,21
	≥ 5% Si	230	0,017	0,033	0,044	0,060	0,07	0,10	0,12			345	0,021	0,043	0,057	0,078	0,09	0,12
NE	≤ 850 N/mm²	250	0,017	0,033	0,044	0,060	0,07	0,10	0,12		375	0,021	0,043	0,057	0,078	0,09	0,12	0,16

Our Carbo-coating is available as an option to improve chip flow and tool life



Ratio end mills Alu RF 100 A

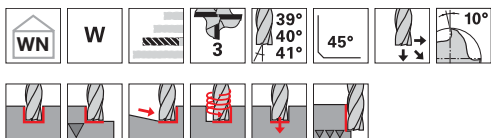

Tool material	Solid carbide	
Surface	○	○
Type	W	W
Shank form	HA	HB

P	
M	
K	
N	•
S	
H	

GUHRING NAVIGATOR

Cutting data page 328

- nano polished cutting edges
- neck clearance
- centre cutting

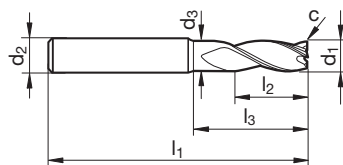

Aluminum, non-ferrous metals and plastics

Article no. **3473** **6703**

d1 h8	d2 h6	d3	l1	l2	l3	c	Z	Code no.
mm	mm	mm	mm	mm	mm	mm x 45°		
6.00	6.00	5.50	65	13.0	28.0	0.06	3	6.000
8.00	8.00	7.50	75	19.0	38.0	0.08	3	8.000
10.00	10.00	9.20	80	22.0	38.0	0.10	3	10.000
12.00	12.00	11.20	93	26.0	46.0	0.12	3	12.000
16.00	16.00	15.00	108	32.0	58.0	0.16	3	16.000
20.00	20.00	19.00	126	38.0	74.0	0.20	3	20.000

ISO	Hardness	vc	fz (mm/z) / Ø							vc	fz (mm/z) / Ø						
			3	6	8	10	12	16	20		3	6	8	10	12	16	20
N	≤ 5% Si	500	0,020	0,039	0,052	0,080	0,10	0,13	0,16	750	0,025	0,051	0,068	0,104	0,12	0,17	0,21
	≥ 5% Si	230	0,017	0,033	0,044	0,060	0,07	0,10	0,12	345	0,021	0,043	0,057	0,078	0,09	0,12	0,16
NE	≤ 850 N/mm ²	250	0,017	0,033	0,044	0,060	0,07	0,10	0,12	375	0,021	0,043	0,057	0,078	0,09	0,12	0,16

Our Carbo-coating is available as an option to improve chip flow and tool life

Ratio end mills Alu RF 100 A

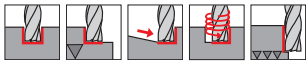

P **GUHRING NAVIGATOR**
M Cutting data page 328
K
N ●
S
H

- nano polished cutting edges
- re-inforced core
- neck clearance
- centre cutting

Tool material	Solid carbide	
Surface	○	○
Type	W	W
Shank form	HA	HB

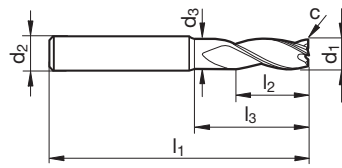

Article no. **6730** **6731**

d1 h8	d2 h6	d3	l1	l2	l3	c	Z	Code no.
mm	mm	mm	mm	mm	mm	mm x 45°		
5.00	6.00	4.80	57	15.0	19.4	0.05	3	5.000
6.00	6.00	5.70	65	18.0	28.0	0.06	3	6.000
8.00	8.00	7.70	75	24.0	38.0	0.08	3	8.000
10.00	10.00	9.50	80	30.0	38.0	0.10	3	10.000
12.00	12.00	11.50	93	36.0	46.0	0.12	3	12.000
16.00	16.00	15.50	108	48.0	58.0	0.16	3	16.000
20.00	20.00	19.50	126	60.0	74.0	0.20	3	20.000

ISO	Hardness	vc	fz (mm/z) / Ø							vc	fz (mm/z) / Ø						
			3	6	8	10	12	16	20		3	6	8	10	12	16	20
N	≤ 5% Si	400	0,016	0,031	0,042	0,064	0,08	0,10	0,13	450	0,010	0,020	0,026	0,040	0,048	0,064	0,080
	≥ 5% Si	200	0,013	0,027	0,035	0,048	0,06	0,08	0,10	210	0,008	0,017	0,022	0,030	0,036	0,048	0,060
NE	≤ 850 N/mm ²	190	0,013	0,027	0,035	0,048	0,06	0,08	0,10	220	0,008	0,017	0,022	0,030	0,036	0,048	0,060

Our Carbo-coating is available as an option to improve chip flow and tool life

Aluminum, non-ferrous metals and plastics



Ratio end mills Alu RF 100 A

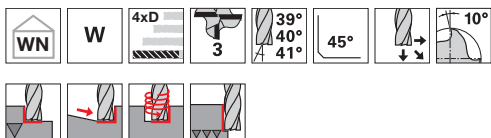

P	
M	
K	
N	•
S	
H	

GUHRING NAVIGATOR

Cutting data page 328

- nano polished cutting edges
- re-inforced core
- centre cutting

Tool material	Solid carbide	
Surface	○	○
Type	W	W
Shank form	HA	HB

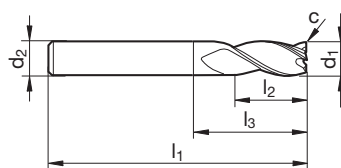

Article no.

6732

6733

d1 h8	d2 h6	l1	l2	l3	c	Z	Code no.
mm	mm	mm	mm	mm	mm x 45°		
6.00	6.00	65	24.0	29.0	0.06	3	6.000
8.00	8.00	75	32.0	39.0	0.08	3	8.000
10.00	10.00	100	40.0	60.0	0.10	3	10.000
12.00	12.00	100	48.0	55.0	0.12	3	12.000
16.00	16.00	125	64.0	77.0	0.16	3	16.000
20.00	20.00	150	80.0	100.0	0.20	3	20.000

ISO	Hardness	vc	fz (mm/z) / Ø							vc	fz (mm/z) / Ø						
			3	6	8	10	12	16	20		3	6	8	10	12	16	20
N	≤ 5% Si	400	0,016	0,031	0,042	0,064	0,08	0,10	0,13	450	0,010	0,020	0,026	0,040	0,048	0,064	0,080
	≥ 5% Si	200	0,013	0,027	0,035	0,048	0,06	0,08	0,10		210	0,008	0,017	0,022	0,030	0,036	0,048
NE	≤ 850 N/mm ²	190	0,013	0,027	0,035	0,048	0,06	0,08	0,10	220	0,008	0,017	0,022	0,030	0,036	0,048	0,060

Our Carbo-coating is available as an option to improve chip flow and tool life

Aluminum, non-ferrous metals and plastics

Ratio end mills Alu RF 100 A

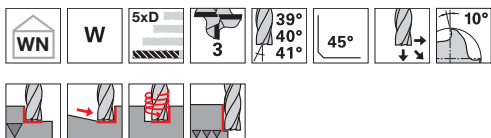

P	
M	
K	
N	•
S	
H	

GUHRING NAVIGATOR

Cutting data page 328

- nano polished cutting edges
- re-inforced core
- centre cutting

Tool material	Solid carbide	
Surface	○	○
Type	W	W
Shank form	HA	HB

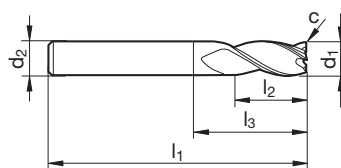

Article no. **6734** **6735**

d1 h8	d2 h6	l1	l2	l3	c	Z	Code no.
mm	mm	mm	mm	mm	mm x 45°		
6.00	6.00	75	30.0	39.0	0.06	3	6.000
8.00	8.00	86	40.0	50.0	0.08	3	8.000
10.00	10.00	100	50.0	60.0	0.10	3	10.000
12.00	12.00	120	60.0	75.0	0.12	3	12.000
16.00	16.00	150	80.0	102.0	0.16	3	16.000
20.00	20.00	175	100.0	125.0	0.20	3	20.000

ISO	Hardness	vc	fz (mm/z) / Ø							vc	fz (mm/z) / Ø						
			3	6	8	10	12	16	20		3	6	8	10	12	16	20
N	≤ 5% Si	400	0,016	0,031	0,042	0,064	0,08	0,10	0,13	450	0,010	0,020	0,026	0,040	0,048	0,064	0,080
	≥ 5% Si	200	0,013	0,027	0,035	0,048	0,06	0,08	0,10		210	0,008	0,017	0,022	0,030	0,036	0,048
NE	≤ 850 N/mm ²	190	0,013	0,027	0,035	0,048	0,06	0,08	0,10	220		0,008	0,017	0,022	0,030	0,036	0,048

Our Carbo-coating is available as an option to improve chip flow and tool life



Ratio end mills Alu RF 100 A

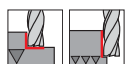

P **GUHRING NAVIGATOR**
M ○ Cutting data page 328
K
N ●
S ○
H
 • neck clearance
 • centre cutting

Tool material	Solid carbide	
Surface	○	○
Type	W	W
Shank form	HA	HB

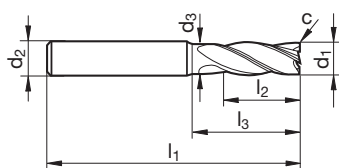

Aluminum, non-ferrous metals and plastics

Article no. **3202** **3319**

d1 h8	d2 h6	d3	l1	l2	l3	c	Z	Code no.
mm	mm	mm	mm	mm	mm	mm x 45°		
4.00	6.00	3.80	57	11.0	18.0	0.10	4	4.000
5.00	6.00	4.80	57	13.0	18.0	0.10	4	5.000
6.00	6.00	5.70	57	13.0	20.0	0.15	4	6.000
8.00	8.00	7.70	63	19.0	26.0	0.15	4	8.000
10.00	10.00	9.50	72	22.0	30.0	0.20	4	10.000
12.00	12.00	11.50	83	26.0	36.0	0.20	4	12.000
16.00	16.00	15.50	92	32.0	42.0	0.35	4	16.000
20.00	20.00	19.50	104	38.0	52.0	0.45	4	20.000

ISO	Hardness	vc	fz (mm/z) / Ø							vc	fz (mm/z) / Ø						
			3	6	8	10	12	16	20		3	6	8	10	12	16	20
N	≤ 5% Si	400	0,016	0,031	0,042	0,064	0,08	0,10	0,13	450	0,010	0,020	0,026	0,040	0,048	0,064	0,080
	≥ 5% Si	200	0,013	0,027	0,035	0,048	0,06	0,08	0,10	210	0,008	0,017	0,022	0,030	0,036	0,048	0,060
NE	≤ 850 N/mm ²	190	0,013	0,027	0,035	0,048	0,06	0,08	0,10	220	0,008	0,017	0,022	0,030	0,036	0,048	0,060

Our Carbo-coating is available as an option to improve chip flow and tool life

Ratio end mills Alu RF 100 A 90°

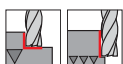

P	
M	
K	
N	•
S	
H	

GUHRING NAVIGATOR

Cutting data page 328

- without corner protection chamfer
- neck clearance
- centre cutting

Tool material	Solid carbide
Surface	○
Type	W
Shank form	HA

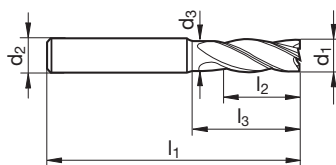

Article no. **6762**

d1 h8	d2 h6	d3	l1	l2	l3	Z	Code no.
mm	mm	mm	mm	mm	mm		
3.00	6.00	2.80	57	8.0	15.0	4	3.000
4.00	6.00	3.80	57	11.0	18.0	4	4.000
5.00	6.00	4.80	57	13.0	18.0	4	5.000
6.00	6.00	5.70	57	13.0	20.0	4	6.000
8.00	8.00	7.70	63	19.0	26.0	4	8.000
10.00	10.00	9.50	72	22.0	30.0	4	10.000
12.00	12.00	11.50	83	26.0	36.0	4	12.000
16.00	16.00	15.50	92	32.0	42.0	4	16.000
20.00	20.00	19.50	104	38.0	52.0	4	20.000

ISO	Hardness	vc	fz (mm/z) / Ø							vc	fz (mm/z) / Ø						
			3	6	8	10	12	16	20		3	6	8	10	12	16	20
N	≤ 5% Si	400	0,016	0,031	0,042	0,064	0,08	0,10	0,13	450	0,010	0,020	0,026	0,040	0,048	0,064	0,080
	≥ 5% Si	200	0,013	0,027	0,035	0,048	0,06	0,08	0,10	210	0,008	0,017	0,022	0,030	0,036	0,048	0,060
NE	≤ 850 N/mm ²	190	0,013	0,027	0,035	0,048	0,06	0,08	0,10	220	0,008	0,017	0,022	0,030	0,036	0,048	0,060

Aluminum, non-ferrous metals and plastics



Ratio end mills Alu RF 100 A

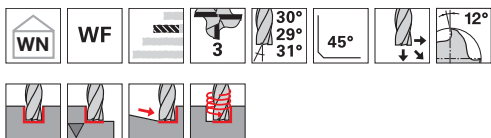

P	
M	
K	
N	•
S	
H	

GUHRING NAVIGATOR

Cutting data page 328

- neck clearance
- centre cutting

Tool material	Solid carbide	
Surface	○	○
Type	WF	WF
Shank form	HA	HB

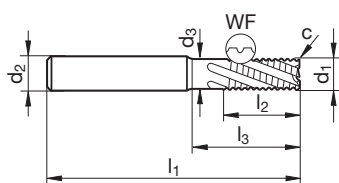

Aluminum, non-ferrous metals and plastics

Article no. **6868** **6869**

d1 h8	d2 h6	d3	l1	l2	l3	c	Z	Code no.
mm	mm	mm	mm	mm	mm	mm x 45°		
6.00	6.00	5.70	57	13.0	20.0	0.06	3	6.000
8.00	8.00	7.70	63	19.0	26.0	0.08	3	8.000
10.00	10.00	9.50	72	22.0	30.0	0.10	3	10.000
12.00	12.00	11.50	83	26.0	36.0	0.12	3	12.000
16.00	16.00	15.50	92	32.0	42.0	0.16	3	16.000
20.00	20.00	19.50	104	38.0	52.0	0.20	3	20.000
25.00	25.00	24.00	121	45.0	63.0	0.25	3	25.000

ISO	Hardness	vc	fz (mm/z) / Ø							vc	fz (mm/z) / Ø						
			3	6	8	10	12	16	20		3	6	8	10	12	16	20
N	≤ 5% Si	375	0,011	0,021	0,028	0,037	0,044	0,059	0,074	440	0,012	0,024	0,032	0,043	0,051	0,068	0,085
	≥ 5% Si																
NE	≤ 850 N/mm ²	200	0,010	0,019	0,026	0,035	0,042	0,056	0,070	230	0,011	0,022	0,029	0,040	0,048	0,064	0,081

Our Carbo-coating is available as an option to improve chip flow and tool life

Ratio end mills Alu RF 100 A

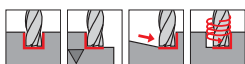

P **GUHRING NAVIGATOR**
Cutting data page 328

M

K

N •

S

H

- neck clearance
- centre cutting

Tool material	Solid carbide	
Surface	○	○
Type	WF	WF
Shank form	HA	HB

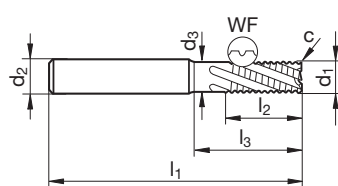

Article no. **6870** **6871**

d1 h8	d2 h6	d3	l1	l2	l3	c	Z	Code no.
mm	mm	mm	mm	mm	mm	mm x 45°		
6.00	6.00	5.70	65	13.0	28.0	0.06	3	6.000
8.00	8.00	7.70	75	19.0	38.0	0.08	3	8.000
10.00	10.00	9.50	80	22.0	38.0	0.10	3	10.000
12.00	12.00	11.50	93	26.0	46.0	0.12	3	12.000
16.00	16.00	15.50	108	32.0	58.0	0.16	3	16.000
20.00	20.00	19.50	126	38.0	74.0	0.20	3	20.000

ISO	Hardness	vc	fz (mm/z) / Ø							vc	fz (mm/z) / Ø						
			3	6	8	10	12	16	20		3	6	8	10	12	16	20
N	≤ 5% Si	375	ap = 1,0 x D								ap = 1,5 x D						
	≥ 5% Si		180	0,011	0,021	0,028	0,037	0,044	0,059		0,074	440	0,012	0,024	0,032	0,043	0,051
NE	≤ 850 N/mm ²	200	ap = 1,0 x D								ap max = 0,75 x D						
			0,010	0,019	0,026	0,035	0,042	0,056	0,070		210	0,011	0,022	0,029	0,040	0,048	0,064
			ap = 1,0 x D								ap max = 0,75 x D						
			0,010	0,019	0,026	0,035	0,042	0,056	0,070		230	0,011	0,022	0,029	0,040	0,048	0,064

Our Carbo-coating is available as an option to improve chip flow and tool life

Aluminum, non-ferrous metals and plastics



Slot drills GA 200 A (3-fluted)

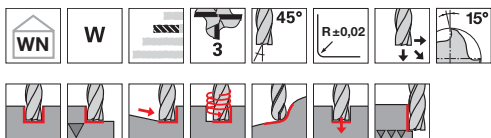

Tool material	Solid carbide
Surface	○
Type	W
Shank form	HA

P **GUHRING NAVIGATOR**
M Cutting data page 330
K
N ●
S
H

- with internal coolant supply
- neck clearance
- centre cutting

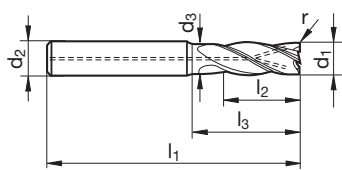

Aluminum, non-ferrous metals and plastics

Article no. **3367**

d1 h10	d2 h6	d3	l1	l2	l3	r	Z	Code no.
mm	mm	mm	mm	mm	mm	mm		
6.00	6.00	5.70	57	10.0	20.0	1.0	3	6.000
8.00	8.00	7.70	63	16.0	26.0	1.0	3	8.000
10.00	10.00	9.50	72	19.0	30.0	1.5	3	10.000
12.00	12.00	11.50	83	22.0	36.0	1.5	3	12.000
12.00	12.00	11.50	83	22.0	36.0	2.0	3	12.020
12.00	12.00	11.50	83	22.0	36.0	2.5	3	12.025
12.00	12.00	11.50	83	22.0	36.0	4.0	3	12.040
16.00	16.00	15.50	92	26.0	42.0	2.0	3	16.000
16.00	16.00	15.50	92	26.0	42.0	2.5	3	16.025
16.00	16.00	15.50	92	26.0	42.0	3.0	3	16.030
16.00	16.00	15.50	92	26.0	42.0	4.0	3	16.040
20.00	20.00	19.50	104	32.0	52.0	2.5	3	20.000
20.00	20.00	19.50	104	32.0	52.0	2.0	3	20.020
20.00	20.00	19.50	104	32.0	52.0	3.0	3	20.030
20.00	20.00	19.50	104	32.0	52.0	4.0	3	20.040
25.00	25.00	24.50	121	38.0	63.0	2.0	3	25.020
25.00	25.00	24.50	121	38.0	63.0	3.0	3	25.030
25.00	25.00	24.50	121	38.0	63.0	4.0	3	25.040

ISO	Hardness	vc	fz (mm/z) / Ø							vc	fz (mm/z) / Ø						
			3	6	8	10	12	16	20		3	6	8	10	12	16	20
N	≤ 5% Si	300	0,015	0,030	0,040	0,055	0,066	0,088	0,110	400	0,017	0,035	0,046	0,063	0,076	0,101	0,127
	≥ 5% Si	180	0,014	0,027	0,036	0,050	0,060	0,080	0,100		300	0,016	0,031	0,041	0,058	0,069	0,092
NE	Mg-alloys nonfer. met.	150	0,013	0,025	0,034	0,045	0,054	0,072	0,090	180	0,014	0,024	0,029	0,039	0,052	0,062	0,083
		200	0,014	0,027	0,036	0,050	0,060	0,080	0,100		230	0,016	0,031	0,041	0,058	0,069	0,092

Our Carbo-coating is available as an option to improve chip flow and tool life

End mills (single-fluted)

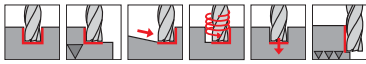

P **GUHRING NAVIGATOR**
M Cutting data page 329
K
N •
S
H • polished flutes
 • centre cutting

Tool material	Solid carbide
Surface	○
Type	W
Shank form	HA



Aluminum, non-ferrous metals and plastics

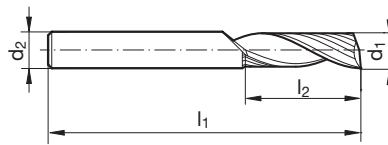

Article no. **6793**

d1 h10	d2 h6	l1	l2	Z	Code no.
mm	mm	mm	mm		
2.00	2.00	38	10.0	1	2.000
3.00	3.00	39	12.0	1	3.000
4.00	4.00	40	15.0	1	4.000
5.00	5.00	50	16.0	1	5.000
6.00	6.00	57	20.0	1	6.000
8.00	8.00	63	22.0	1	8.000
10.00	10.00	73	25.0	1	10.000
12.00	12.00	83	30.0	1	12.000
16.00	16.00	92	35.0	1	16.000

ISO	Hardness	vc	fz (mm/z) / Ø							vc	fz (mm/z) / Ø						
			3	6	8	10	12	16	20		3	6	8	10	12	16	20
N	≤ 7% Si	300	0,019	0,037	0,050	0,065	0,08	0,10	0,13	350	0,021	0,043	0,057	0,075	0,09	0,12	0,15
	≥ 7% Si	160	0,013	0,025	0,034	0,046	0,06	0,07	0,09		190	0,018	0,036	0,048	0,064	0,08	0,10
NE	≤ 850 N/mm ²	175	0,013	0,025	0,034	0,046	0,06	0,07	0,09	290	0,014	0,029	0,039	0,053	0,06	0,08	0,11

Our Carbo-coating is available as an option to improve chip flow and tool life



Al slot drills (2-fluted)

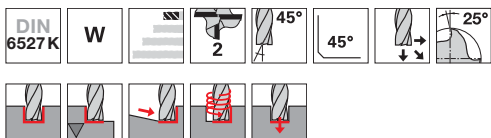

Tool material	Solid carbide	
Surface	○	○
Type	W	W
Shank form	HA	HB

P	
M	
K	
N	•
S	
H	

GUHRING NAVIGATOR

Cutting data page 335

• centre cutting

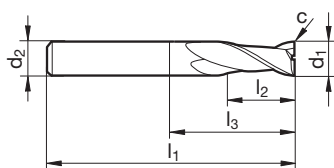

Aluminum, non-ferrous metals and plastics

Article no. **3310** **3126**

d1 h8	d2 h6	l1	l2	l3	c	Z	Code no.
mm	mm	mm	mm	mm	mm x 45°		
3.00	6.00	50	4.0	7.9	0.03	2	3.000
4.00	6.00	54	5.0	8.9	0.03	2	4.000
5.00	6.00	54	6.0	11.4	0.03	2	5.000
6.00	6.00	54	7.0	18.0	0.03	2	6.000
8.00	8.00	58	9.0	22.0	0.05	2	8.000
10.00	10.00	66	11.0	26.0	0.05	2	10.000
12.00	12.00	73	12.0	28.0	0.10	2	12.000
14.00	14.00	75	14.0	30.0	0.10	2	14.000
16.00	16.00	82	16.0	34.0	0.10	2	16.000
18.00	18.00	84	18.0	36.0	0.10	2	18.000
20.00	20.00	92	20.0	42.0	0.10	2	20.000

ISO	Hardness	vc	fz (mm/z) / Ø							vc	fz (mm/z) / Ø						
			3	6	8	10	12	16	20		3	6	8	10	12	16	20
N	≤ 7% Si	300	0,019	0,037	0,050	0,065	0,08	0,10	0,13	350	0,021	0,043	0,057	0,075	0,09	0,12	0,15
	≥ 7% Si	160	0,013	0,025	0,034	0,046	0,06	0,07	0,09	190	0,018	0,036	0,048	0,064	0,08	0,10	0,13
NE	≤ 850 N/mm ²	175	0,013	0,025	0,034	0,046	0,06	0,07	0,09	290	0,014	0,029	0,039	0,053	0,06	0,08	0,11

Al slot drills (2-fluted)

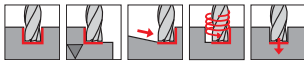

P	
M	
K	
N	•
S	
H	

GUHRING NAVIGATOR

Cutting data page 335

• centre cutting

Tool material	Solid carbide	
Surface	○	○
Type	W	W
Shank form	HA	HB

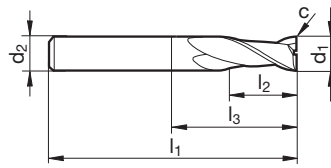

Article no. **3309** **3059**

d1 h8	d2 h6	l1	l2	l3	c	Z	Code no.
mm	mm	mm	mm	mm	mm x 45°		
3.00	6.00	57	7.0	10.9	0.03	2	3.000
4.00	6.00	57	8.0	11.9	0.03	2	4.000
5.00	6.00	57	10.0	15.4	0.03	2	5.000
6.00	6.00	57	10.0	21.0	0.03	2	6.000
8.00	8.00	63	16.0	27.0	0.05	2	8.000
10.00	10.00	72	19.0	32.0	0.05	2	10.000
12.00	12.00	83	22.0	38.0	0.10	2	12.000
14.00	14.00	83	22.0	38.0	0.10	2	14.000
14.00	16.00	92	26.0	37.4	0.10	2	14.001
16.00	16.00	92	26.0	44.0	0.10	2	16.000
18.00	18.00	92	26.0	44.0	0.10	2	18.000
18.00	20.00	104	32.0	46.0	0.10	2	18.001
20.00	20.00	104	32.0	54.0	0.10	2	20.000

ISO	Hardness	vc	fz (mm/z) / Ø							vc	fz (mm/z) / Ø						
			3	6	8	10	12	16	20		3	6	8	10	12	16	20
N	≤ 7% Si	300	0,019	0,037	0,050	0,065	0,08	0,10	0,13	350	0,021	0,043	0,057	0,075	0,09	0,12	0,15
	≥ 7% Si	160	0,013	0,025	0,034	0,046	0,06	0,07	0,09		190	0,018	0,036	0,048	0,064	0,08	0,10
NE	≤ 850 N/mm ²	175	0,013	0,025	0,034	0,046	0,06	0,07	0,09	290	0,014	0,029	0,039	0,053	0,06	0,08	0,11

Aluminum, non-ferrous metals and plastics



XL Al slot drills (2-fluted)

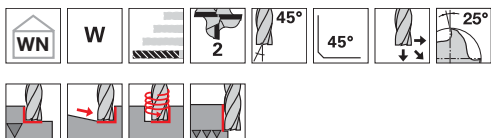

P	
M	
K	
N	•
S	
H	

GUHRING NAVIGATOR

Cutting data page 335

• centre cutting

Tool material	Solid carbide
Surface	○
Type	W
Shank form	HA

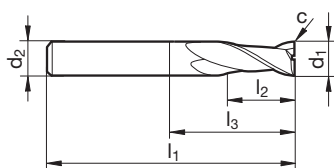

Article no. **3358**

d1 h10	d2 h6	l1	l2	l3	c	Z	Code no.
mm	mm	mm	mm	mm	mm x 45°		
5.00	5.00	75	30.0	47.0	0.03	2	5.000
6.00	6.00	75	30.0	39.0	0.03	2	6.000
8.00	8.00	100	40.0	64.0	0.05	2	8.000
10.00	10.00	100	40.0	60.0	0.05	2	10.000
12.00	12.00	150	45.0	105.0	0.10	2	12.000
16.00	16.00	150	65.0	102.0	0.10	2	16.000

ISO	Hardness	vc	fz (mm/z) / Ø							vc	fz (mm/z) / Ø						
			3	6	8	10	12	16	20		3	6	8	10	12	16	20
N	≤ 7% Si	220	0,015	0,030	0,040	0,052	0,06	0,08	0,10	270	0,009	0,019	0,025	0,033	0,039	0,052	0,065
	≥ 7% Si	130	0,013	0,025	0,033	0,045	0,05	0,07	0,09		140	0,008	0,016	0,021	0,028	0,034	0,045
NE	≤ 850 N/mm ²	70	0,010	0,020	0,027	0,037	0,04	0,06	0,07	220	0,006	0,013	0,017	0,023	0,028	0,037	0,046

Aluminum, non-ferrous metals and plastics

Roughing end mills GS 100 A (coarse teeth)

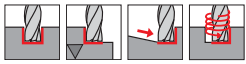

P	
M	
K	
N	•
S	
H	

GUHRING NAVIGATOR

Cutting data page 331

- with internal coolant supply
- centre cutting

Tool material	Solid carbide	
Surface	○	○
Type	WR	WR
Shank form	HB	HB

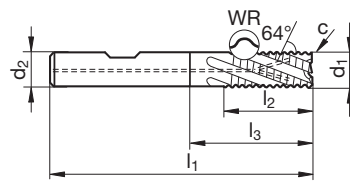

Article no. **3364** **3127**

d1 h10	d2 h6	l1	l2	l3	c	Z	Code no.
mm	mm	mm	mm	mm	mm x 45°		
6.00	6.00	57	10.0	21.0	0.30	3	6.000
8.00	8.00	63	16.0	27.0	0.30	3	8.000
10.00	10.00	72	19.0	32.0	0.30	3	10.000
12.00	12.00	83	22.0	38.0	0.50	3	12.000
14.00	14.00	83	22.0	38.0	0.50	3	14.000
16.00	16.00	92	26.0	44.0	0.50	3	16.000
18.00	18.00	92	26.0	44.0	0.50	3	18.000
20.00	20.00	104	32.0	54.0	0.50	3	20.000
25.00	25.00	121	45.0	65.0	0.60	3	25.000

ISO	Hardness	vc	fz (mm/z) / Ø							vc	fz (mm/z) / Ø						
			3	6	8	10	12	16	20		3	6	8	10	12	16	20
N	≤ 7% Si	350	0,010	0,019	0,026	0,035	0,042	0,056	0,070	410	0,011	0,022	0,029	0,040	0,048	0,064	0,081
	≥ 7% Si	180	0,009	0,018	0,024	0,032	0,038	0,051	0,064	210	0,010	0,021	0,028	0,037	0,044	0,059	0,074
NE	≤ 850 N/mm ²	180	0,009	0,018	0,024	0,032	0,038	0,051	0,064	210	0,010	0,021	0,028	0,037	0,044	0,059	0,074

Aluminum, non-ferrous metals and plastics



Ratio end mills Superfinish RF 100 SF



P • **GUHRING NAVIGATOR**
M • Cutting data page 328
K •
N •
S •
H ○ • neck clearance
 • centre cutting

Tool material	Solid carbide	
Surface	F	F
Type	NH	NH
Shank form	HA	HB

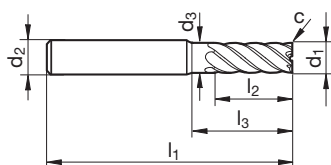

Aluminum, non-ferrous metals and plastics

Article no. **6709** **6710**

d1 h10	d2 h6	d3	l1	l2	l3	c	Z	Code no.
mm	mm	mm	mm	mm	mm	mm x 45°		
4.00	6.00	3.80	57	11.0	18.0	0.05	5	4.000
5.00	6.00	4.80	57	13.0	18.0	0.05	5	5.000
6.00	6.00	5.70	57	13.0	20.0	0.05	5	6.000
8.00	8.00	7.70	63	19.0	26.0	0.10	5	8.000
10.00	10.00	9.50	72	22.0	30.0	0.10	5	10.000
12.00	12.00	11.50	83	26.0	36.0	0.10	5	12.000
16.00	16.00	15.50	92	32.0	42.0	0.15	5	16.000
20.00	20.00	19.50	104	38.0	52.0	0.15	5	20.000
25.00	25.00	24.00	121	45.0	63.0	0.20	5	25.000

ISO	Hardness	vc	fz (mm/z) / Ø								vc	fz (mm/z) / Ø							
			3	6	8	10	12	16	20	3		6	8	10	12	16	20		
P	≤ 850 N/mm ²	340	0,036	0,072	0,096	0,138	0,17	0,22	0,28	360	0,017	0,034	0,046	0,066	0,08	0,11	0,13		
	≥ 850 N/mm ²	250	0,031	0,062	0,083	0,115	0,14	0,18	0,23	270	0,015	0,030	0,040	0,055	0,07	0,09	0,11		
M	≤ 750 N/mm ²	220	0,031	0,062	0,083	0,115	0,14	0,18	0,23	240	0,015	0,030	0,040	0,055	0,07	0,09	0,11		
	≥ 750 N/mm ²	110	0,024	0,048	0,064	0,092	0,11	0,15	0,18	120	0,011	0,021	0,028	0,040	0,05	0,06	0,08		
S	Ni-based	60	0,019	0,039	0,052	0,074	0,09	0,12	0,15	60	0,008	0,017	0,022	0,032	0,04	0,05	0,06		
	Ti-based	110	0,028	0,055	0,074	0,104	0,12	0,17	0,21	120	0,013	0,026	0,035	0,050	0,06	0,08	0,10		
K	≤ 240 HB	300	0,038	0,076	0,101	0,150	0,18	0,24	0,30	320	0,018	0,036	0,048	0,072	0,09	0,11	0,14		
	≥ 240 HB	260	0,035	0,069	0,092	0,127	0,15	0,20	0,25	280	0,017	0,033	0,044	0,061	0,07	0,10	0,12		
N	≤ 7 % Si	900	0,045	0,090	0,120	0,184	0,22	0,29	0,37	1000	0,021	0,043	0,057	0,088	0,11	0,14	0,18		
	≥ 7 % Si	430	0,038	0,076	0,101	0,138	0,17	0,22	0,28	460	0,018	0,036	0,048	0,066	0,08	0,11	0,13		

Ratio end mills Superfinish RF 100 SF

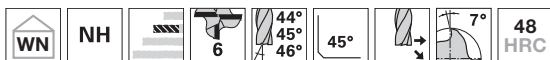

P • **GUHRING NAVIGATOR**

M • Cutting data page 328

K •

N •

S •

H ○ • neck clearance
• centre cutting

Tool material	Solid carbide	
Surface	F	F
Type	NH	NH
Shank form	HA	HB

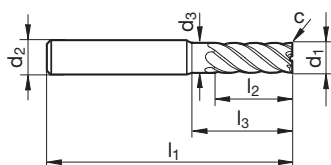

Article no. **3631** **3632**

d1 h10	d2 h6	d3	l1	l2	l3	c	Z	Code no.
mm	mm	mm	mm	mm	mm	mm x 45°		
8.00	8.00	7.70	63	19.0	26.0	0.10	6	8.000
10.00	10.00	9.50	72	22.0	30.0	0.10	6	10.000
12.00	12.00	11.50	83	26.0	36.0	0.10	6	12.000
16.00	16.00	15.50	92	32.0	42.0	0.15	6	16.000
20.00	20.00	19.50	104	38.0	52.0	0.15	6	20.000
25.00	25.00	24.00	121	45.0	63.0	0.20	6	25.000

ISO	Hardness	vc	fz (mm/z) / Ø						vc	fz (mm/z) / Ø							
			3	6	8	10	12	16		20	3	6	8	10	12	16	20
P	≤ 850 N/mm ²	340	0,036	0,072	0,096	0,138	0,17	0,22	0,28	360	0,017	0,034	0,046	0,066	0,08	0,11	0,13
	≥ 850 N/mm ²	250	0,031	0,062	0,083	0,115	0,14	0,18	0,23	270	0,015	0,030	0,040	0,055	0,07	0,09	0,11
M	≤ 750 N/mm ²	220	0,031	0,062	0,083	0,115	0,14	0,18	0,23	240	0,015	0,030	0,040	0,055	0,07	0,09	0,11
	≥ 750 N/mm ²	110	0,024	0,048	0,064	0,092	0,11	0,15	0,18	120	0,011	0,021	0,028	0,040	0,05	0,06	0,08
S	Ni-based	60	0,019	0,039	0,052	0,074	0,09	0,12	0,15	60	0,008	0,017	0,022	0,032	0,04	0,05	0,06
	Ti-based	110	0,028	0,055	0,074	0,104	0,12	0,17	0,21	120	0,013	0,026	0,035	0,050	0,06	0,08	0,10
K	≤ 240 HB	300	0,038	0,076	0,101	0,150	0,18	0,24	0,30	320	0,018	0,036	0,048	0,072	0,09	0,11	0,14
	≥ 240 HB	260	0,035	0,069	0,092	0,127	0,15	0,20	0,25	280	0,017	0,033	0,044	0,061	0,07	0,10	0,12
N	≤ 7 % Si	900	0,045	0,090	0,120	0,184	0,22	0,29	0,37	1000	0,021	0,043	0,057	0,088	0,11	0,14	0,18
	≥ 7 % Si	430	0,038	0,076	0,101	0,138	0,17	0,22	0,28	460	0,018	0,036	0,048	0,066	0,08	0,11	0,13

Aluminum, non-ferrous metals and plastics



Ratio end mills Superfinish RF 100 SF



- P** •
- M** •
- K** •
- N** •
- S** •
- H** ○

GUHRING NAVIGATOR

Cutting data page 328

- neck clearance
- centre cutting

Tool material	Solid carbide	
Surface	F	F
Type	NH	NH
Shank form	HA	HB

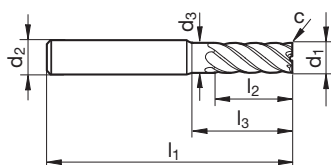

Article no. **3897** **3898**

d1 h10	d2 h6	d3	l1	l2	l3	c	Z	Code no.
mm	mm	mm	mm	mm	mm	mm x 45°		
4.00	6.00	3.80	65	12.0	26.0	0.05	5	4.000
5.00	6.00	4.80	65	15.0	26.0	0.05	5	5.000
6.00	6.00	5.70	65	18.0	28.0	0.05	5	6.000
8.00	8.00	7.70	75	24.0	38.0	0.10	5	8.000
10.00	10.00	9.50	80	30.0	38.0	0.10	5	10.000
12.00	12.00	11.50	93	36.0	46.0	0.10	5	12.000
16.00	16.00	15.50	108	48.0	58.0	0.15	5	16.000
20.00	20.00	19.50	126	60.0	74.0	0.15	5	20.000

Aluminum, non-ferrous metals and plastics

ISO	Hardness	vc	fz (mm/z) / Ø								vc	fz (mm/z) / Ø							
			3	6	8	10	12	16	20	3		6	8	10	12	16	20		
			ap = l2		HPC	HSC		ae max. = 0,10 x D		ap = l2			ae max. = 0,02 x D						
P	≤ 850 N/mm ²	340	0,036	0,072	0,096	0,138	0,17	0,22	0,28	360	0,017	0,034	0,046	0,066	0,08	0,11	0,13		
	≥ 850 N/mm ²	250	0,031	0,062	0,083	0,115	0,14	0,18	0,23	270	0,015	0,030	0,040	0,055	0,07	0,09	0,11		
M	≤ 750 N/mm ²	220	0,031	0,062	0,083	0,115	0,14	0,18	0,23	240	0,015	0,030	0,040	0,055	0,07	0,09	0,11		
	≥ 750 N/mm ²	110	0,024	0,048	0,064	0,092	0,11	0,15	0,18	120	0,011	0,021	0,028	0,040	0,05	0,06	0,08		
S	Ni-based	60	0,019	0,039	0,052	0,074	0,09	0,12	0,15	60	0,008	0,017	0,022	0,032	0,04	0,05	0,06		
	Ti-based	110	0,028	0,055	0,074	0,104	0,12	0,17	0,21	120	0,013	0,026	0,035	0,050	0,06	0,08	0,10		
K	≤ 240 HB	300	0,038	0,076	0,101	0,150	0,18	0,24	0,30	320	0,018	0,036	0,048	0,072	0,09	0,11	0,14		
	≥ 240 HB	260	0,035	0,069	0,092	0,127	0,15	0,20	0,25	280	0,017	0,033	0,044	0,061	0,07	0,10	0,12		
N	≤ 7 % Si	900	0,045	0,090	0,120	0,184	0,22	0,29	0,37	1000	0,021	0,043	0,057	0,088	0,11	0,14	0,18		
	≥ 7 % Si	430	0,038	0,076	0,101	0,138	0,17	0,22	0,28	460	0,018	0,036	0,048	0,066	0,08	0,11	0,13		

Ratio end mills Superfinish RF 100 SF 90°



P • **GUHRING NAVIGATOR**

M • Cutting data page 328

K •

N •

S •

H •

- without corner protection chamfer
- neck clearance
- centre cutting

Tool material **Solid carbide**

Surface **a**

Type **NH**

Shank form **HA**

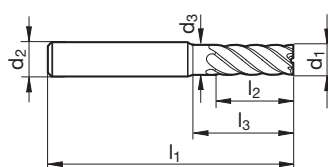

Article no. **6763**

d1 h10	d2 h6	d3	l1	l2	l3	Z	Code no.
mm	mm	mm	mm	mm	mm		
4.00	6.00	3.80	65	12.0	26.0	5	4.000
5.00	6.00	4.80	65	15.0	26.0	5	5.000
6.00	6.00	5.70	65	18.0	28.0	5	6.000
8.00	8.00	7.70	75	24.0	38.0	5	8.000
10.00	10.00	9.50	80	30.0	38.0	5	10.000
12.00	12.00	11.50	93	36.0	46.0	5	12.000
16.00	16.00	15.50	108	48.0	58.0	5	16.000
20.00	20.00	19.50	126	60.0	74.0	5	20.000

ISO	Hardness	vc	fz (mm/z) / Ø								vc	fz (mm/z) / Ø							
			3	6	8	10	12	16	20	3		6	8	10	12	16	20		
			ap = l2		HPC	HSC		ae max. = 0,10 x D				ap = l2			ae max. = 0,02 x D				
P	≤ 850 N/mm ²	340	0,036	0,072	0,096	0,138	0,17	0,22	0,28	360	0,017	0,034	0,046	0,066	0,08	0,11	0,13		
	≥ 850 N/mm ²	250	0,031	0,062	0,083	0,115	0,14	0,18	0,23	270	0,015	0,030	0,040	0,055	0,07	0,09	0,11		
M	≤ 750 N/mm ²	220	0,031	0,062	0,083	0,115	0,14	0,18	0,23	240	0,015	0,030	0,040	0,055	0,07	0,09	0,11		
	≥ 750 N/mm ²	110	0,024	0,048	0,064	0,092	0,11	0,15	0,18	120	0,011	0,021	0,028	0,040	0,05	0,06	0,08		
S	Ni-based	60	0,019	0,039	0,052	0,074	0,09	0,12	0,15	60	0,008	0,017	0,022	0,032	0,04	0,05	0,06		
	Ti-based	110	0,028	0,055	0,074	0,104	0,12	0,17	0,21	120	0,013	0,026	0,035	0,050	0,06	0,08	0,10		
K	≤ 240 HB	300	0,038	0,076	0,101	0,150	0,18	0,24	0,30	320	0,018	0,036	0,048	0,072	0,09	0,11	0,14		
	≥ 240 HB	260	0,035	0,069	0,092	0,127	0,15	0,20	0,25	280	0,017	0,033	0,044	0,061	0,07	0,10	0,12		
N	≤ 7 % Si	900	0,045	0,090	0,120	0,184	0,22	0,29	0,37	1000	0,021	0,043	0,057	0,088	0,11	0,14	0,18		
	≥ 7 % Si	430	0,038	0,076	0,101	0,138	0,17	0,22	0,28	460	0,018	0,036	0,048	0,066	0,08	0,11	0,13		

GSS 2000

Put an end to complex tool clamping and adjustment.
With GSS 2000 you can clamp your tools easily, quickly and securely.



Benefit from the advantages of GSS 2000:

- ⇒ high-performance spindle, hence quick change time
- ⇒ overheating protection for holder
- ⇒ automatic mode possible (equipment automatically selects the correct heating program)
- ⇒ error detection choosing wrong chuck/program
- ⇒ heating programs for standard/reinforced and very small holder/shrink fit extensions
- ⇒ maximum rigidity
- ⇒ highest cutting rates

GM 3000

Tool holders with peripheral cooling

- ⇒ optimal chip evacuation
- ⇒ high process reliability
- ⇒ improved cooling lubrication



GÜHROJET

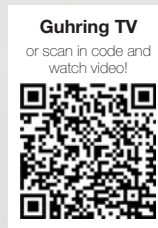
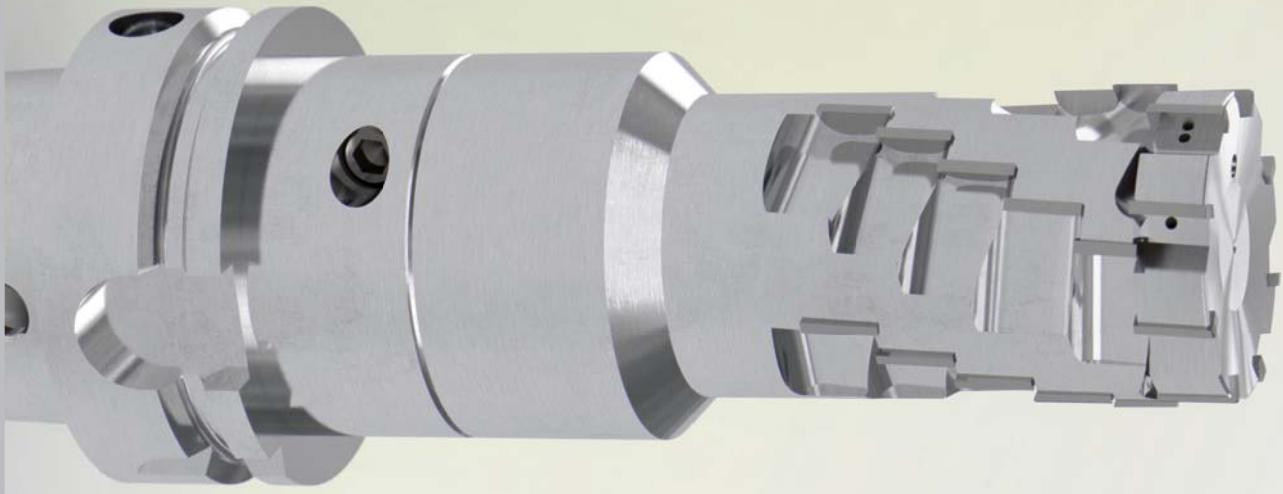

Advantages at a glance

- ▶ modular design with cutting ring and ingenious clamping chuck
- ▶ axially and radially adjustable for accurate concentricity
- ▶ PCD cutting edges can be re-ground 10 times
- ▶ chip guide elements and radial coolant exit

DIAMOND / PCD MILLING CUTTERS

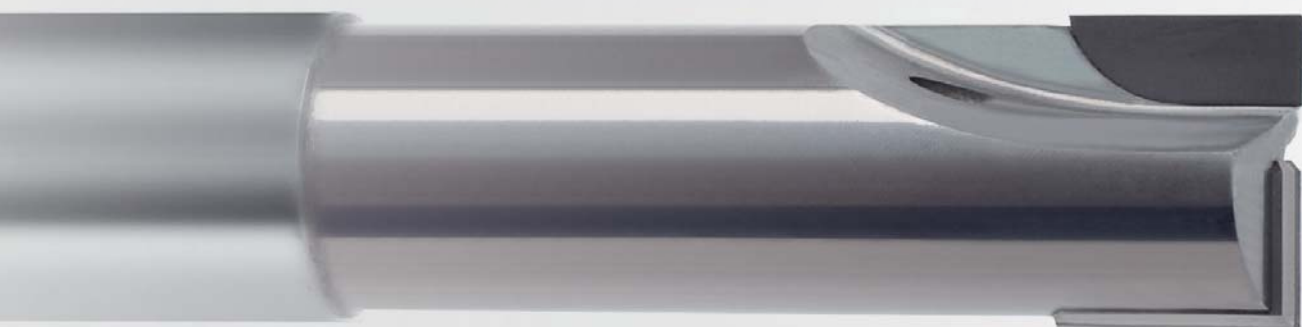

PKD
PCD

P	M	K	N	S	H	Tool illustration	Z	Hardness	Shank form	Length	Helix angle °	Tool material	Surface	d1/mm	Article no.	Page
Slot drills XL (3-fluted)							3	HA	HA	30°	VHM	⊖	3.000 - 16.000	6721	143	
Slot drills with corner radius (2-fluted)							2	HA	HA	30°	VHM	⊖	6.000 - 12.000	6722	144	
End mills with corner radius (4-fluted)							4	HA	HA	30°	VHM	⊖	6.000 - 12.000	6723	145	
Ball nose slot drills (2-fluted)							2	HA	HA	30°	VHM	⊖	3.000 - 12.000	6724	146	
Ball nose end mills (4-fluted)							4	HA	HA	30°	VHM	⊖	3.000 - 12.000	6725	147	
Kevlar end mills FR 100							4-8	-HA	-HA	0°	VHM	⊖	4.000 - 12.700	6769	149	
Kevlar end mills CR 100							4-8	-HA	-HA	0°	VHM	⊖	4.000 - 12.700	6770	150	
Kevlar end mills CR 100							6+	HA	HA	0°	VHM	⊖	4.000 - 16.000	6720	152	
Kevlar end mills CR 100							6+	HA	HA	0°	VHM	⊖	4.000 - 16.000	6717	153	
Kevlar end mills CR 100							6+	HA	HA	0°	VHM	⊖	4.000 - 16.000	6719	154	
Kevlar end mills with internal cooling CR 100 Air							6+	HA	HA	0°	VHM	⊖	6.000 - 16.000	6718	155	
PCD slot drills (2-fluted)							2	HA	HA	2-4°	PKD	○	4.000 - 20.000	5492	157	
PCD slot drills (2-fluted)							2	HA	HA	2-4°	PKD	○	4.000 - 20.000	5493	158	
PCD slot drills (3-fluted)							3	HA	HA	4°	PKD	○	14.000 - 20.000	5495	159	
PCD slot drills (3-fluted)							3	Cyl	Cyl	4°	PKD	○	14.000 - 20.000	5496	160	

Diamond/PCD milling cutters



P	M	K	N	S	H	Tool illustration	Z	Hardness	Shank form	Length	Helix angle °	Tool material	Surface	d1/mm	Article no.	Page
---	---	---	---	---	---	-------------------	---	----------	------------	--------	---------------	---------------	---------	-------	-------------	------

HSC face milling cutters

												PKD		32.000 - 125.000	3016	162
--	--	--	--	--	--	--	--	--	--	--	--	------------	--	------------------	-------------	-----

HSC face milling cutters

														63.000 - 250.000	4201	164
--	--	--	--	--	--	--	--	--	--	--	--	--	--	------------------	-------------	-----

PCD cartridges HSC

												PKD		30.000 - 30.300	4204	165
--	--	--	--	--	--	--	--	--	--	--	--	------------	--	-----------------	-------------	-----

Coolant distributor

															4203	166
--	--	--	--	--	--	--	--	--	--	--	--	--	--	--	-------------	-----

Diamond/PCD milling cutters

Cristall - diamond coating

for the machining of graphite, CFK, AlSi-alloys and ceramic



Extreme wear resistance
for highly productive machining

Large chip chambers
for good chip evacuation

Sharp cutting edges and good coating surface
ensures a very long tool life

Like its naturally occurring relative, this diamond-coating possesses an outstanding hardness in excess of 8000 HV. Thanks to the so-called sp³-structure in which the carbon atoms with both materials are spatially arranged, Cristall is qualified for highly abrasive applications such as for example the machining of GFRP and CFRP, aluminium-alloys, ceramics and graphite. Thanks to different coating thicknesses it is adapted to the specific application task. Due to the high coating temperature it is only possible to deposit it on carbide. Thanks to Guhring's in-house carbide production this is not a problem. Process related re-grinding and re-coating is not possible.

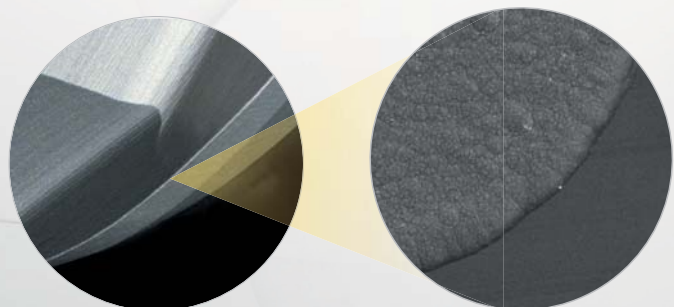



Slot drills XL (3-fluted)

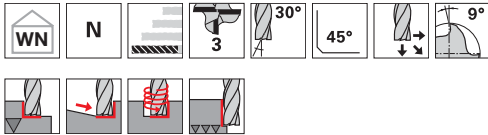

P	
M	
K	
N	•
S	
H	

GUHRING NAVIGATOR

Cutting data page 335

- for fibre composite plastics
- for graphite
- centre cutting

Tool material **Solid carbide**

Surface **Ⓚ**

Type **N**

Shank form **HA**

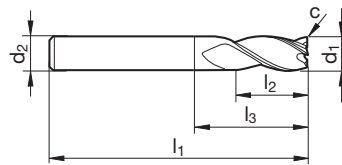

Article no. **6721**

d1 h10	d2 h6	l1	l2	l3	c	Z	Code no.
mm	mm	mm	mm	mm	mm x 45°		
3.00	3.00	75	20.0	47.0	0.05	3	3.000
4.00	4.00	75	25.0	47.0	0.05	3	4.000
5.00	5.00	75	30.0	47.0	0.05	3	5.000
6.00	6.00	75	30.0	39.0	0.05	3	6.000
8.00	8.00	100	40.0	64.0	0.10	3	8.000
10.00	10.00	100	40.0	60.0	0.10	3	10.000
12.00	12.00	150	45.0	105.0	0.10	3	12.000
16.00	16.00	150	65.0	102.0	0.15	3	16.000

Diamond/PCD milling cutters

ISO	Hardness	vc	fz (mm/z) / Ø							vc	fz (mm/z) / Ø						
			3	6	8	10	12	16	20		3	6	8	10	12	16	20
N	≥ 7% Si	420	0,020	0,045	0,060	0,075	0,09	0,12	0,15	500	0,018	0,036	0,048	0,060	0,07	0,10	0,12
	≥ 14% Si																
Graphit	≤ 8 µm	320	0,025	0,060	0,080	0,100	0,12	0,15	0,18	370	0,020	0,054	0,072	0,090	0,10	0,12	0,15
CFK GFK Aramid	–	200	0,015	0,030	0,040	0,050	0,06	0,08	0,10	250	0,012	0,024	0,032	0,040	0,05	0,07	0,09

Slot drills with corner radius (2-fluted)

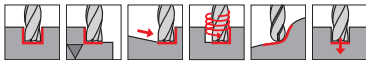

P **GUHRING NAVIGATOR**

M Cutting data page 335

- K**
- N** •
- S**
- H**

- for fibre composite plastics
- for graphite
- centre cutting

Tool material **Solid carbide**

Surface **Ⓟ**

Type **N**

Shank form **HA**

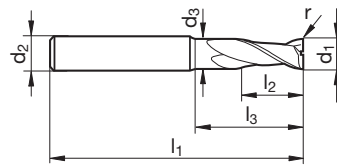

Article no. **6722**

d1 h10	d2 h6	d3	l1	l2	l3	r	Z	Code no.
mm	mm	mm	mm	mm	mm	mm		
6.00	6.00	5.70	57	10.0	20.0	0.5	2	6.005
6.00	6.00	5.70	57	10.0	20.0	1.0	2	6.010
8.00	8.00	7.70	63	16.0	26.0	0.5	2	8.005
8.00	8.00	7.70	63	16.0	26.0	1.0	2	8.010
10.00	10.00	9.50	72	19.0	30.0	0.5	2	10.005
10.00	10.00	9.50	72	19.0	30.0	1.0	2	10.010
12.00	12.00	11.50	83	22.0	36.0	0.5	2	12.005
12.00	12.00	11.50	83	22.0	36.0	1.0	2	12.010

Diamond/PCD milling cutters

ISO	Hardness	vc	fz (mm/z) / Ø							vc	fz (mm/z) / Ø						
			3	6	8	10	12	16	20		3	6	8	10	12	16	20
N	≥ 7% Si	420	0,020	0,045	0,060	0,075	0,09	0,12	0,15	500	0,018	0,036	0,048	0,060	0,07	0,10	0,12
	≥ 14% Si		220	0,015	0,030	0,040	0,050	0,06	0,08		0,10	270	0,012	0,024	0,032	0,040	0,05
Graphit	≤ 8 µm	320	0,025	0,060	0,080	0,100	0,12	0,15	0,18	370	0,020	0,054	0,072	0,090	0,10	0,12	0,15
CFK GFK Aramid	-	200	0,015	0,030	0,040	0,050	0,06	0,08	0,10	250	0,012	0,024	0,032	0,040	0,05	0,07	0,09



End mills with corner radius (4-fluted)

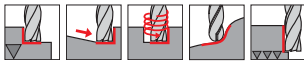

P **GUHRING NAVIGATOR**

M Cutting data page 335

K	
N	•
S	
H	

- for fibre composite plastics
- for graphite
- neck clearance
- centre cutting

Tool material **Solid carbide**

Surface **ⓓ**

Type **N**

Shank form **HA**

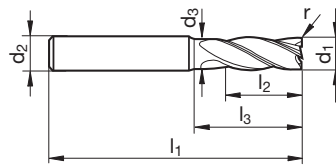

Article no. **6723**

d1 h10	d2 h6	d3	l1	l2	l3	r	Z	Code no.
mm	mm	mm	mm	mm	mm	mm		
6.00	6.00	5.70	57	13.0	20.0	1.0	4	6.010
6.00	6.00	5.70	57	13.0	20.0	0.5	4	6.005
8.00	8.00	7.70	63	19.0	26.0	0.5	4	8.005
8.00	8.00	7.70	63	19.0	26.0	1.0	4	8.010
10.00	10.00	9.50	72	22.0	30.0	0.5	4	10.005
10.00	10.00	9.50	72	22.0	30.0	1.0	4	10.010
12.00	12.00	11.50	83	26.0	36.0	0.5	4	12.005
12.00	12.00	11.50	83	26.0	36.0	1.0	4	12.010

Diamond/PCD milling cutters

ISO	Hardness	vc	fz (mm/z) / Ø							vc	fz (mm/z) / Ø						
			3	6	8	10	12	16	20		3	6	8	10	12	16	20
N	≥ 7% Si ≥ 14% Si	420	0,020	0,045	0,060	0,075	0,09	0,12	0,15	500	0,018	0,036	0,048	0,060	0,07	0,10	0,12
			220	0,015	0,030	0,040	0,050	0,06	0,08		0,10	270	0,012	0,024	0,032	0,040	0,05
Graphit	≤ 8 µm	320	0,025	0,060	0,080	0,100	0,12	0,15	0,18	370	0,020	0,054	0,072	0,090	0,10	0,12	0,15
CFK GFK Aramid	–	200	0,015	0,030	0,040	0,050	0,06	0,08	0,10	250	0,012	0,024	0,032	0,040	0,05	0,07	0,09

Ball nose slot drills (2-fluted)

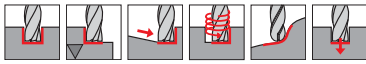

P **GUHRING NAVIGATOR**

M Cutting data page 336

K	
N	•
S	
H	

- for fibre composite plastics
- for graphite
- centre cutting

Tool material	Solid carbide
Surface	ⓓ
Type	N
Shank form	HA

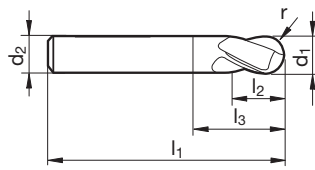

Article no. **6724**

d1 h10	d2 h6	l1	l2	l3	r	Z	Code no.
mm	mm	mm	mm	mm	mm		
3.00	6.00	57	7.0	11.9	1.5	2	3.000
4.00	6.00	57	8.0	13.4	2.0	2	4.000
5.00	6.00	57	10.0	16.9	2.5	2	5.000
6.00	6.00	57	10.0	21.0	3.0	2	6.000
8.00	8.00	63	16.0	27.0	4.0	2	8.000
10.00	10.00	72	19.0	32.0	5.0	2	10.000
12.00	12.00	83	22.0	38.0	6.0	2	12.000

Diamond/PCD milling cutters

ISO	Hardness	vc	fz (mm/z) / Ø														
			3	6	8	10	12	16	20								
N	≥ 7% Si ≥ 14% Si	ap = 0,2 x D	30°		9°		ap = 0,2 x D		ap = 0,03 x D								
			420	0,020	0,045	0,060	0,075	0,09	0,12	0,15	500	0,018	0,036	0,048	0,060	0,07	0,10
Graphit	≤ 8 µm	320	0,025	0,060	0,080	0,100	0,12	0,15	0,18	370	0,020	0,054	0,072	0,090	0,10	0,12	0,15
CFK GFK Aramid	-	200	0,015	0,030	0,040	0,050	0,06	0,08	0,10	250	0,012	0,024	0,032	0,040	0,05	0,07	0,09



Ball nose end mills (4-fluted)

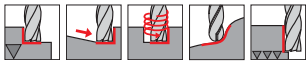

P **GUHRING NAVIGATOR**
M Cutting data page 336
K
N ●
S ● for fibre composite plastics
H ● for graphite
 ● centre cutting

Tool material	Solid carbide
Surface	ⓓ
Type	N
Shank form	HA

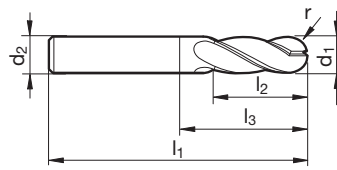

Article no. **6725**

d1 h10	d2 h6	l1	l2	l3	r	Z	Code no.
mm	mm	mm	mm	mm	mm		
3.00	3.00	75	20.0	47.0	1.5	4	3.000
4.00	4.00	75	25.0	47.0	2.0	4	4.000
5.00	5.00	75	30.0	47.0	2.5	4	5.000
6.00	6.00	75	30.0	39.0	3.0	4	6.000
8.00	8.00	100	40.0	64.0	4.0	4	8.000
10.00	10.00	100	40.0	60.0	5.0	4	10.000
12.00	12.00	150	45.0	105.0	6.0	4	12.000

Diamond/PCD milling cutters

ISO	Hardness	vc	fz (mm/z) / Ø							
			3	6	8	10	12	16	20	
N	≥ 7% Si ≥ 14% Si	ap = 0,2 x D	ae = 0,2 x D							
			0,020	0,045	0,060	0,075	0,09	0,12	0,15	
Graphit	≤ 8 µm	ap = 0,05 x D	ae = 0,03 x D							
CFK GFK	–		0,018	0,036	0,048	0,060	0,07	0,10	0,12	
Aramid	–	ap = 0,05 x D	ae = 0,03 x D							
			0,012	0,024	0,032	0,040	0,05	0,07	0,09	
		ap = 0,05 x D	ae = 0,03 x D							
			0,020	0,054	0,072	0,090	0,10	0,12	0,15	
		ap = 0,05 x D	ae = 0,03 x D							
			0,012	0,024	0,032	0,040	0,05	0,07	0,09	

FR 100 - High-performance milling cutter for the machining of automotive CFRP and GFRP components

FR 100



Economical machining of modern fibre reinforced plastic composites (FRPC) such as carbon fibre and glass fibre reinforced plastics (CFRP/GFRP) requires high-tech tool especially for series production. With this type of application the aim is foremost to prevent delamination or fibre projections as well as thermal damage. The adapted macro and micro geometry of the FR 100 milling cutter enables a reliable cutting of all fibres, auxiliary fibres and matrix parts without projections even with complex multi-layer 3D fibre structure – regardless of fibre orientation.

+ optimal MACHINING QUALITY

+ MINIMISATION of manual re-working

+ high PROCESS PARAMETERS

+ long TOOL LIFE



Compression cut

The new geometry of the FR 100 enables a process reliable fibre cutting in 3D fibre structures.

The shearing cutting action prevents delamination, fibre fraying and thermal damage.



Surface finish quality

Bearbeitungsergebnisse in Machining results in CFRP, GFRP and aramid show maximum edge quality. This reduces the manual reworking and simplifies the finish machining of FRC components in series production.

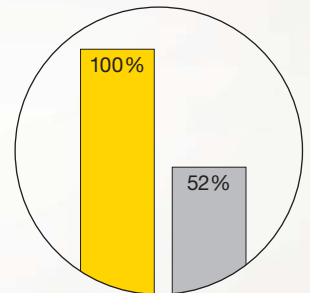

Economic efficiency

In direct comparison to competitor tools FR 100 achieves up to double the tool life with considerably better component quality.



Kevlar end mills FR 100



P
M
K
N
S
H

GUHRING NAVIGATOR

Cutting data page 335

- for fibre composite plastics
- with face milling geometry

Tool material	Solid carbide
Surface	ⓓ
Type	FR 100
Shank form	HA

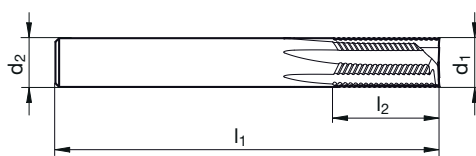

Article no. **6769**

d1 e10	d2 h6	l1	l2	Z	Code no.
mm	mm	mm	mm		
4.00	6.00	66	15.0	4	4.000
4.76	4.76	63	15.0	4	4.762
6.00	6.00	70	20.0	4	6.000
6.35	6.35	63	15.0	4	6.350
8.00	8.00	75	25.0	6	8.000
9.52	9.52	76	18.0	6	9.525
12.70	12.70	88	25.4	8	12.700

Diamond/PCD milling cutters

ISO	Hardness	vc	fz (mm/z) / Ø		vc	fz (mm/z) / Ø	
			D4 - D8	D9 - D16		D4 - D8	D9 - D16
CFK GFK Aramid	-	180	0,03 - 0,06	0,065 - 0,12	450	0,03 - 0,06	0,065 - 0,12

Kevlar end mills FR 100



P **GUHRING NAVIGATOR**
M Cutting data page 335
K
N
S
H

- for fibre composite plastics
- with drilling geometry

Tool material	Solid carbide
Surface	ⓓ
Type	FR 100
Shank form	HA

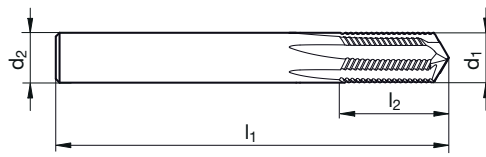

Article no. **6770**

d1 e10	d2 h6	l1	l2	Z	Code no.
mm	mm	mm	mm		
4.00	6.00	66	15.0	4	4.000
4.76	4.76	63	15.0	4	4.762
6.00	6.00	70	20.0	4	6.000
6.35	6.35	63	15.0	4	6.350
8.00	8.00	75	25.0	6	8.000
9.52	9.52	76	18.0	6	9.525
12.70	12.70	88	25.4	8	12.700

ISO	Hardness	vc	fz (mm/z) / Ø		vc	fz (mm/z) / Ø	
			D4 - D8	D9 - D16		D4 - D8	D9 - D16
CFK GFK Aramid	-	180	0,03 - 0,06	0,065 - 0,12	450	0,03 - 0,06	0,065 - 0,12

Diamond/PCD milling cutters

CR 100 – Kevlar end mills

for CFC and similar compounds

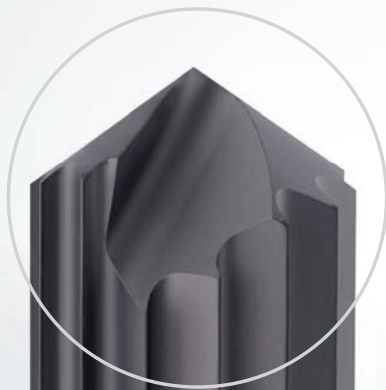

Art. no.: 6720

With drill point for plunging and subsequent milling operation

Art. no.: 6719

With milling face for oblique plunging, slotting and milling operations

Art. no.: 6717

Without face cutting edges for external slotting and trimming



High number of straight-fluted cutting edges
for delamination-free cutting of CFRP / GFRP



Cristall-coating

extreme wear resistance
for highly productive machining



Milled CFC workpiece edge
without delamination machined with
a Guhring CR 100 end mill



Typical delamination on a milled CFC
workpiece edge

Kevlar end mills CR 100

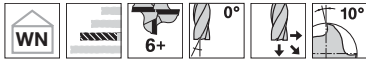

P **GUHRING NAVIGATOR**
M Cutting data page 335
K
N
S
H

- for fibre composite plastics
- with drilling geometry

Tool material	Solid carbide
Surface	ⓓ
Type	CR 100
Shank form	HA

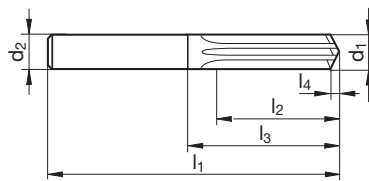

Article no. **6720**

d1 e10	d2 h6	l1	l2	l3	l4	Z	Code no.
mm	mm	mm	mm	mm	mm		
4.00	4.00	55	12.0	27.0	1.3	6	4.000
6.00	6.00	65	18.0	29.0	1.9	8	6.000
8.00	8.00	75	24.0	39.0	2.5	10	8.000
10.00	10.00	80	30.0	40.0	3.1	12	10.000
12.00	12.00	93	36.0	48.0	3.7	14	12.000
16.00	16.00	108	42.0	60.0	4.9	14	16.000

ISO	Hardness	vc	fz (mm/z) / Ø		vc	fz (mm/z) / Ø	
			D4 - D8	D9 - D16		D4 - D8	D9 - D16
CFK GFK Aramid	–	250	0,03 - 0,06	0,065 - 0,12	500	0,03 - 0,06	0,065 - 0,12

Diamond/PCD milling cutters



Kevlar end mills CR 100

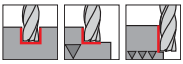
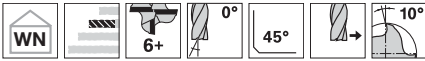

P **GUHRING** NAVIGATOR

M Cutting data page 335

- K**
- N**
- S**
- H**

- for fibre composite plastics
- without centre cutting

Tool material **Solid carbide**

Surface **ⓓ**

Type **CR 100**

Shank form **HA**

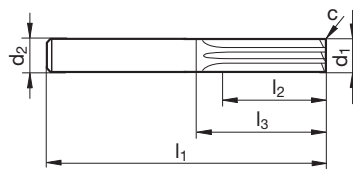

Article no. **6717**

d1 e10	d2 h6	l1	l2	l3	c	Z	Code no.
mm	mm	mm	mm	mm	mm x 45°		
4.00	6.00	57	10.0	19.4	0.10	6	4.000
6.00	6.00	65	15.0	29.0	0.15	8	6.000
8.00	8.00	75	20.0	39.0	0.15	10	8.000
10.00	10.00	80	25.0	40.0	0.15	12	10.000
12.00	12.00	93	32.0	48.0	0.15	14	12.000
16.00	16.00	108	34.0	60.0	0.15	14	16.000

ISO	Hardness	vc	fz (mm/z) / Ø		vc	fz (mm/z) / Ø	
			D4 - D8	D9 - D16		D4 - D8	D9 - D16
CFK GFK Aramid	–	250	0,03 - 0,06	0,065 - 0,12	500	0,03 - 0,06	0,065 - 0,12

Diamond/PCD milling cutters

Kevlar end mills CR 100

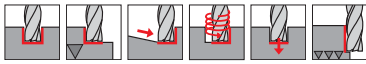
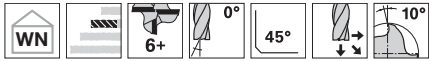

- P**
- M**
- K**
- N**
- S**
- H**

GUHRING NAVIGATOR

Cutting data page 335

- for fibre composite plastics
- with face milling geometry

Tool material	Solid carbide
Surface	ⓓ
Type	CR 100
Shank form	HA

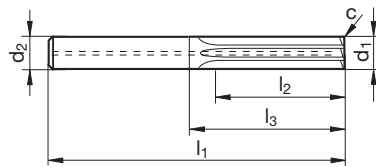

Article no. **6719**

d1 e10	d2 h6	l1	l2	l3	c	Z	Code no.
mm	mm	mm	mm	mm	mm x 45°		
4.00	6.00	57	10.0	19.4	0.32	6	4.000
6.00	6.00	65	15.0	29.0	0.48	8	6.000
8.00	8.00	75	20.0	39.0	0.64	10	8.000
10.00	10.00	80	25.0	40.0	0.80	12	10.000
12.00	12.00	93	32.0	48.0	0.96	14	12.000
16.00	16.00	108	34.0	60.0	1.28	14	16.000

ISO	Hardness	vc	fz (mm/z) / Ø		vc	fz (mm/z) / Ø	
			D4 - D8	D9 - D16		D4 - D8	D9 - D16
CFK GFK Aramid	–	250	0,03 - 0,06	0,065 - 0,12	500	0,03 - 0,06	0,065 - 0,12

Diamond/PCD milling cutters



Kevlar end mills with internal cooling CR 100 Air

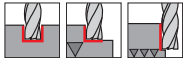
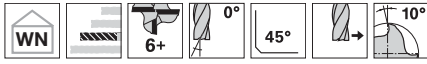

P **GUHRING**NAVIGATOR

M Cutting data page 335

- K**
- N**
- S**
- H**

- for fibre composite plastics
- with internal coolant supply
- without centre cutting

Tool material **Solid carbide**

Surface **Ⓚ**

Type **CR 100**

Shank form **HA**

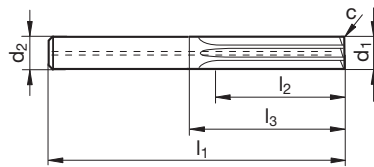

Article no. **6718**

d1 e10	d2 h6	l1	l2	l3	c	Z	Code no.
mm	mm	mm	mm	mm	mm x 45°		
6.00	6.00	70	24.0	34.0	0.15	8	6.000
8.00	8.00	80	32.0	44.0	0.15	10	8.000
10.00	10.00	90	40.0	50.0	0.15	12	10.000
12.00	12.00	110	48.0	65.0	0.15	14	12.000
16.00	16.00	130	64.0	82.0	0.15	14	16.000

ISO	Hardness	vc	fz (mm/z) / Ø		vc	fz (mm/z) / Ø	
			D4 - D8	D9 - D16		D4 - D8	D9 - D16
CFK GFK Aramid	–	250	0,03 - 0,06	0,065 - 0,12	500	0,03 - 0,06	0,065 - 0,12

Diamond/PCD milling cutters

PCD end mill

standard and special solutions for the machining of aluminium and FP





PCD slot drills (2-fluted)

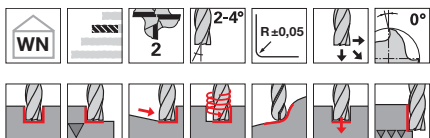

P	
M	
K	
N	•
S	
H	

GUHRING NAVIGATOR

Cutting data page 335

- for fibre composite plastics
- for graphite
- with internal coolant supply
- neck clearance
- centre cutting
- other corner radii on request

Tool material	PCD
Surface	○
Type	
Shank form	HA

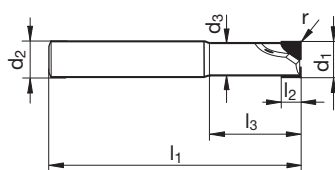

Article no. **5492**

d1	d1	d2 h6	d3	l1	l2	l3	r	Z	Code no.
mm		mm	mm	mm	mm	mm	mm		
4.00	± 0.02	6.00	3.70	51	6.0	6.4	0.1	2	4.000
5.00	± 0.02	6.00	4.70	51	8.0	8.4	0.1	2	5.000
6.00	± 0.02	6.00	5.70	57	8.0	20.0	0.1	2	6.000
8.00	± 0.02	8.00	7.40	63	8.0	26.0	0.1	2	8.000
8.00	± 0.02	8.00	7.40	63	12.0	26.0	0.1	2	8.001
10.00	± 0.02	10.00	9.40	72	8.0	30.0	0.1	2	10.000
10.00	± 0.02	10.00	9.40	72	16.0	30.0	0.1	2	10.001
12.00	± 0.02	12.00	11.20	83	8.0	36.0	0.1	2	12.000
12.00	± 0.02	12.00	11.20	83	16.0	36.0	0.1	2	12.001
14.00	± 0.02	14.00	13.00	83	8.0	36.0	0.1	2	14.000
14.00	± 0.02	14.00	13.00	83	16.0	36.0	0.1	2	14.001
16.00	± 0.02	16.00	15.00	100	12.0	50.0	0.1	2	16.000
16.00	± 0.02	16.00	15.00	100	20.0	50.0	0.1	2	16.001
18.00	± 0.02	18.00	17.00	100	12.0	50.0	0.1	2	18.000
18.00	± 0.02	18.00	17.00	100	20.0	50.0	0.1	2	18.001
20.00	± 0.02	20.00	19.00	100	12.0	48.0	0.1	2	20.000
20.00	± 0.02	20.00	19.00	100	20.0	48.0	0.1	2	20.001

Diamond/PCD milling cutters

ISO	Hardness	vc	fz (mm/z) / Ø							vc	fz (mm/z) / Ø							
			4	6	8	10	12	16	20		4	6	8	10	12	16	20	
N	≥ 7% Si	600	0,025	0,035	0,045	0,060	0,07	0,09	0,10		750	0,020	0,030	0,040	0,050	0,06	0,08	0,09
	≥ 14% Si	260	0,020	0,030	0,040	0,050	0,06	0,07	0,09		350	0,018	0,025	0,035	0,045	0,05	0,06	0,08
Graphit	≤ 8 µm	450	0,040	0,060	0,080	0,100	0,12	0,15	0,18	520	0,030	0,050	0,060	0,070	0,09	0,10	0,12	
CFK GFK Aramid	–	300	0,020	0,030	0,040	0,050	0,06	0,07	0,09	400	0,018	0,025	0,035	0,045	0,05	0,06	0,08	

PCD slot drills (2-fluted)

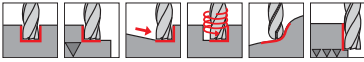
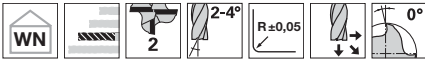

P **GUHRING NAVIGATOR**

M Cutting data page 335

- K** • for fibre composite plastics
- N** • for graphite
- S** • with internal coolant supply
- H** • neck clearance
- centre cutting
- other corner radii on request

Tool material	PCD
Surface	○
Type	
Shank form	HA

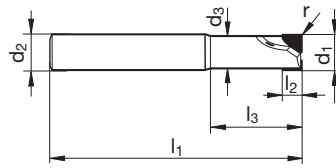

Article no. **5493**

d1	d1	d2 h6	d3	l1	l2	l3	r	Z	Code no.
mm		mm	mm	mm	mm	mm	mm		
4.00	± 0.02	6.00	3.70	70	6.0	6.4	0.1	2	4.000
5.00	± 0.02	6.00	4.70	70	8.0	8.4	0.1	2	5.000
6.00	± 0.02	6.00	5.70	75	8.0	38.0	0.1	2	6.000
8.00	± 0.02	8.00	7.40	100	8.0	63.0	0.1	2	8.000
8.00	± 0.02	8.00	7.40	100	12.0	63.0	0.1	2	8.001
10.00	± 0.02	10.00	9.40	100	8.0	58.0	0.1	2	10.000
10.00	± 0.02	10.00	9.40	100	16.0	58.0	0.1	2	10.001
12.00	± 0.02	12.00	11.20	100	8.0	53.0	0.1	2	12.000
12.00	± 0.02	12.00	11.20	100	16.0	53.0	0.1	2	12.001
14.00	± 0.02	14.00	13.00	100	8.0	53.0	0.1	2	14.000
14.00	± 0.02	14.00	13.00	100	16.0	53.0	0.1	2	14.001
16.00	± 0.02	16.00	15.00	150	12.0	100.0	0.1	2	16.000
16.00	± 0.02	16.00	15.00	150	20.0	100.0	0.1	2	16.001
18.00	± 0.02	18.00	17.00	125	12.0	75.0	0.1	2	18.000
18.00	± 0.02	18.00	17.00	125	20.0	75.0	0.1	2	18.001
18.00	± 0.02	18.00	17.00	150	12.0	100.0	0.1	2	18.002
18.00	± 0.02	18.00	17.00	150	20.0	100.0	0.1	2	18.003
20.00	± 0.02	20.00	19.00	150	12.0	98.0	0.1	2	20.000
20.00	± 0.02	20.00	19.00	150	20.0	98.0	0.1	2	20.001

Diamond/PCD milling cutters

ISO	Hardness	vc	fz (mm/z) / Ø							vc	fz (mm/z) / Ø							
			4	6	8	10	12	16	20		4	6	8	10	12	16	20	
N	≥ 7% Si	600	0,025	0,035	0,045	0,060	0,07	0,09	0,10		750	0,020	0,030	0,040	0,050	0,06	0,08	0,09
	≥ 14% Si	260	0,020	0,030	0,040	0,050	0,06	0,07	0,09		350	0,018	0,025	0,035	0,045	0,05	0,06	0,08
Graphit	≤ 8 µm	450	0,040	0,060	0,080	0,100	0,12	0,15	0,18	520	0,030	0,050	0,060	0,070	0,09	0,10	0,12	
CFK GFK Aramid	-	300	0,020	0,030	0,040	0,050	0,06	0,07	0,09	400	0,018	0,025	0,035	0,045	0,05	0,06	0,08	



PCD slot drills (3-fluted)

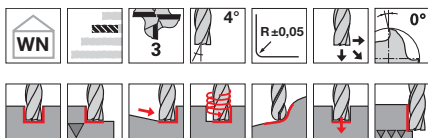

P	
M	
K	
N	•
S	
H	

GUHRING NAVIGATOR

Cutting data page 335

- for fibre composite plastics
- for graphite
- with internal coolant supply
- neck clearance
- centre cutting
- other corner radii on request

Tool material	PCD
Surface	○
Type	
Shank form	HA

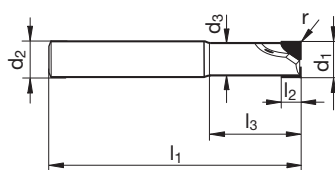

Article no. **5495**

d1	d1	d2 h6	d3	l1	l2	l3	r	Z	Code no.
mm		mm	mm	mm	mm	mm	mm		
14.00	± 0.02	14.00	13.00	83	8.0	38.0	0.1	3	14.000
14.00	± 0.02	14.00	13.00	83	16.0	38.0	0.1	3	14.001
16.00	± 0.02	16.00	15.00	100	12.0	52.0	0.1	3	16.000
16.00	± 0.02	16.00	15.00	100	20.0	52.0	0.1	3	16.001
18.00	± 0.02	18.00	17.00	100	12.0	52.0	0.1	3	18.000
18.00	± 0.02	18.00	17.00	100	20.0	52.0	0.1	3	18.001
20.00	± 0.02	20.00	19.00	100	12.0	50.0	0.1	3	20.000
20.00	± 0.02	20.00	19.00	100	20.0	50.0	0.1	3	20.001

Diamond/PCD milling cutters

ISO	Hardness	vc	fz (mm/z) / Ø							vc	fz (mm/z) / Ø							
			4	6	8	10	12	16	20		4	6	8	10	12	16	20	
N	≥ 7% Si	600	0,025	0,035	0,045	0,060	0,07	0,09	0,10		750	0,020	0,030	0,040	0,050	0,06	0,08	0,09
	≥ 14% Si	260	0,020	0,030	0,040	0,050	0,06	0,07	0,09		350	0,018	0,025	0,035	0,045	0,05	0,06	0,08
Graphit	≤ 8 µm	450	0,040	0,060	0,080	0,100	0,12	0,15	0,18	520	0,030	0,050	0,060	0,070	0,09	0,10	0,12	
CFK GFK Aramid	–	300	0,020	0,030	0,040	0,050	0,06	0,07	0,09	400	0,018	0,025	0,035	0,045	0,05	0,06	0,08	

PCD slot drills (3-fluted)

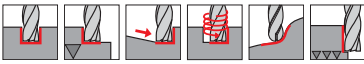
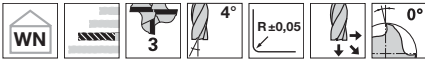

P **GUHRING NAVIGATOR**

M Cutting data page 335

- K** • for fibre composite plastics
- N** • for graphite
- S** • with internal coolant supply
- H** • neck clearance
- centre cutting
- other corner radii on request

Tool material	PCD
Surface	○
Type	
Shank form	cyl.

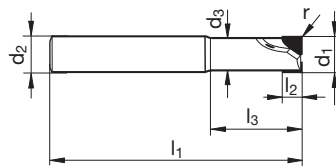

Article no. **5496**

d1	d1	d2 h6	d3	l1	l2	l3	r	Z	Code no.
mm		mm	mm	mm	mm	mm	mm		
14.00	± 0.02	14.00	13.00	100	8.0	38.0	0.1	3	14.000
14.00	± 0.02	14.00	13.00	100	16.0	38.0	0.1	3	14.001
16.00	± 0.02	16.00	15.00	150	12.0	52.0	0.1	3	16.000
16.00	± 0.02	16.00	15.00	150	20.0	52.0	0.1	3	16.001
18.00	± 0.02	18.00	17.00	150	12.0	52.0	0.1	3	18.000
18.00	± 0.02	18.00	17.00	150	20.0	52.0	0.1	3	18.001
20.00	± 0.02	20.00	19.00	150	12.0	50.0	0.1	3	20.000
20.00	± 0.02	20.00	19.00	150	20.0	50.0	0.1	3	20.001

Diamond/PCD milling cutters

ISO	Hardness	vc	fz (mm/z) / Ø							vc	fz (mm/z) / Ø						
			4	6	8	10	12	16	20		4	6	8	10	12	16	20
N	≥ 7% Si	600	0,025	0,035	0,045	0,060	0,07	0,09	0,10	750	0,020	0,030	0,040	0,050	0,06	0,08	0,09
	≥ 14% Si	260	0,020	0,030	0,040	0,050	0,06	0,07	0,09		350	0,018	0,025	0,035	0,045	0,05	0,06
Graphit	≤ 8 µm	450	0,040	0,060	0,080	0,100	0,12	0,15	0,18	520	0,030	0,050	0,060	0,070	0,09	0,10	0,12
CFK GFK Aramid	-	300	0,020	0,030	0,040	0,050	0,06	0,07	0,09	400	0,018	0,025	0,035	0,045	0,05	0,06	0,08

PCD HSC face milling heads PF 1000 G



Monolithic construction with HSK 63 A
other interfaces on request

With integrated balancing screws for maximum speed: i.e. \varnothing 100 mm $n = 26.875$ U/min

Brazed PCD inserts with 8 mm cutting edge length for the machining of shoulders and heels

Radial coolant exits
for effective internal cooling

High tooth number for maximum feed rates with optimal surface finish quality
i.e. $Z = 22$ with \varnothing 125 mm

HSC face milling cutters

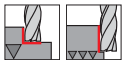
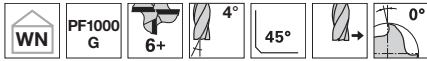

P	
M	
K	
N	•
S	
H	

GUHRING NAVIGATOR

Cutting data page 335

- for fibre composite plastics
- for graphite
- with internal coolant supply

Tool material	PCD
Surface	○
Type	PF 1000 G
Shank form	HSK-A

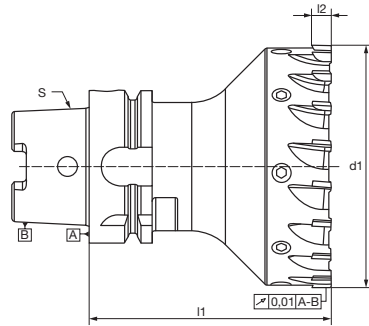

Article no. **3016**

d1 ±0,05	S	l1	l2	Z	Code no.
mm		mm	mm		
32.00	HSK-A 63	132	8.0	8	32.000
40.00	HSK-A 63	132	8.0	10	40.000
50.00	HSK-A 63	132	8.0	12	50.000
63.00	HSK-A 63	132	8.0	14	63.000
80.00	HSK-A 63	132	8.0	16	80.000
100.00	HSK-A 63	132	8.0	18	100.000
125.00	HSK-A 63	132	8.0	22	125.000

Diamond/PCD milling cutters

ISO	Hardness	vc	fz (mm/z) / Ø							vc	fz (mm/z) / Ø						
			32	40	50	63	80	100	125		32	40	50	63	80	100	125
N	≥ 7% Si	1600	0,11	0,12	0,15	0,15	0,15	0,15	1800	0,10	0,10	0,12	0,12	0,12	0,12	0,12	
	≥ 14% Si	500	0,08	0,09	0,10	0,10	0,10	0,10	600	0,06	0,07	0,08	0,08	0,08	0,08	0,08	
Graphit	≤ 8 µm	1000	0,20	0,20	0,20	0,20	0,20	0,20	1200	0,17	0,17	0,17	0,17	0,17	0,17	0,17	
CFK GFK Aramid	-	400	0,10	0,11	0,12	0,12	0,12	0,12	500	0,08	0,08	0,10	0,10	0,10	0,10	0,10	

PF 3000 – face milling cutter

For highest feed rates and optimal surface finishes
for the machining of aluminium

axially adjustable inserts

Standard tool \varnothing 63–250 mm available ex-stock

reduced spindle loading thanks to light aluminium body (i.e. 7.3 kg with D = 250 mm)

Surface finish qualities up to Rz achievable

compatible with **standard tool holders**

PCD inserts available with different geometries

with integrated balancing screws



HSC face milling cutters

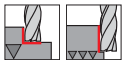

P	
M	
K	
N	•
S	
H	

- axially µm-accurate adjustable
- PCD inserts art. no. 4204 order separately
- defined roughness by selecting insert types
- order GM 300 cutter head holders art. no. 4362/4231 separately
- Coolant distribution screw art. no. 4203 (order separately for Ø 63-125)

Tool material	
Surface	
Type	PF 3000
Shank form	

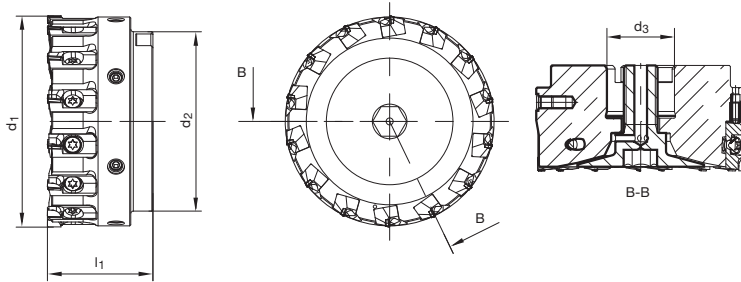

Article no. 4201

d1 ±0,05	d2	d3	l1	kg	Z	Code no.
mm	mm	mm	mm			
63.00	49.00	22.00	40.00	0.34	8	63.000
80.00	65.00	27.00	50.00	0.61	10	80.000
100.00	85.00	32.00	50.00	0.94	14	100.000
125.00	110.00	40.00	63.00	1.77	18	125.000
160.00	145.00	40.00	63.00	2.94	24	160.000
200.00	185.00	40.00	63.00	4.38	28	200.000
250.00	235.00	40.00	63.00	7.32	36	250.000

Diamond/PCD milling cutters

ISO	Hardness	vc max	fz (mm/z) / Ø							vc	fz (mm/z) / Ø														
			63	80	100	125	160	200	250		63	80	100	125	160	200	250								
N	≤ 7% Si	6000	ap max = 5 mm Rz 2 - 4							Art. 4204 30,000 Art. 4204 30,300	6000	ap max = 5 mm Rz 10 - 25							Art. 4204 30,200						
	≤ 14% Si	2000	0,05 - 0,20									2000	0,10 - 0,25												
N	Cu	2000	0,05 - 0,20							2000	0,10 - 0,25							2000	0,10 - 0,25						
	CuZn / CuSn	2000	0,05 - 0,20								2000	0,10 - 0,25													



PCD cartridges HSC

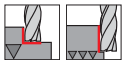

P	
M	
K	
N	•
S	
H	

- for PF 3000
- axial μm -accurate adjustable inserts
- defined roughness by selecting insert types

Tool material	PCD
Surface	○
Type	PF 3000
Shank form	

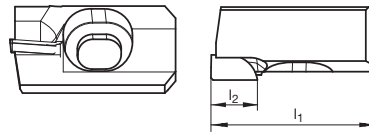

Article no. **4204**

Application	l1	l2	kg	Code no.
	mm	mm		
Rz 2 - 4	23	7.00	0.156	30.000
Rz 10 - 25	23	7.00	0.158	30.200
	23	7.00	0.159	30.300

Diamond/PCD milling cutters

ISO	Hardness	vc max	fz (mm/z) / Ø							vc	fz (mm/z) / Ø						
			63	80	100	125	160	200	250		63	80	100	125	160	200	250
			ap max = 5 mm Rz 2 - 4				Art. 4204 30,000 Art. 4204 30,300			ap max = 5 mm Rz 10 - 25				Art. 4204 30,200			
N	≤ 7% Si	6000	0,05 - 0,20							6000	0,10 - 0,25						
	≤ 14% Si	2000	0,05 - 0,20							2000	0,10 - 0,25						
N	Cu	2000	0,05 - 0,20							2000	0,10 - 0,25						
	CuZn / CuSn	2000	0,05 - 0,20							2000	0,10 - 0,25						

Spare parts

Article no.	Clamping screw	Torx	l1	G
6128			mm	
Code 5,000	M5 x 17	20	17	M5

Article no.	Washer	d1	d2	l1
4207		mm	mm	mm
Code 30,000		5,10	8	2

Coolant distributor



Tool material

Surface

Type

B

PF 3000

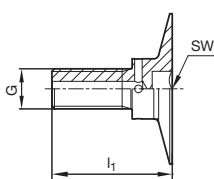

Article no.

4203

l1	G	SW	Code no.
mm		mm	
39	M10	8	63.000
47	M12	10	80.000
48	M16	14	100.000
58	M20	17	125.000
11			160.000
11			200.000
11			250.000

Diamond/PCD milling cutters

Basic milling cutter body in aluminium with refined surface finish:

The basic milling cutter body is manufactured in high-tensile aluminium for the reduction of mass. This reduces the forces on your machine spindle bearing.

PCD inserts:

The cutter heads are available from Ø 63 to 250 mm and carry up to 36 PCD inserts depending on diameter. The PCD inserts are available with different geometries and can be re-ground up to three times.

Coolant distribution disc:

The coolant distribution disc mounted on the basic milling cutter body (up to including Ø 125 mm with coolant distribution screw) ensures an optimal distribution of the delivered coolant to the inserts. It also guarantees the perfect seat of the basic milling cutter body – even at maximum speeds.

Insert axial run-out
 μm accurate adjustable

Balancing screws
for optimal smooth
running

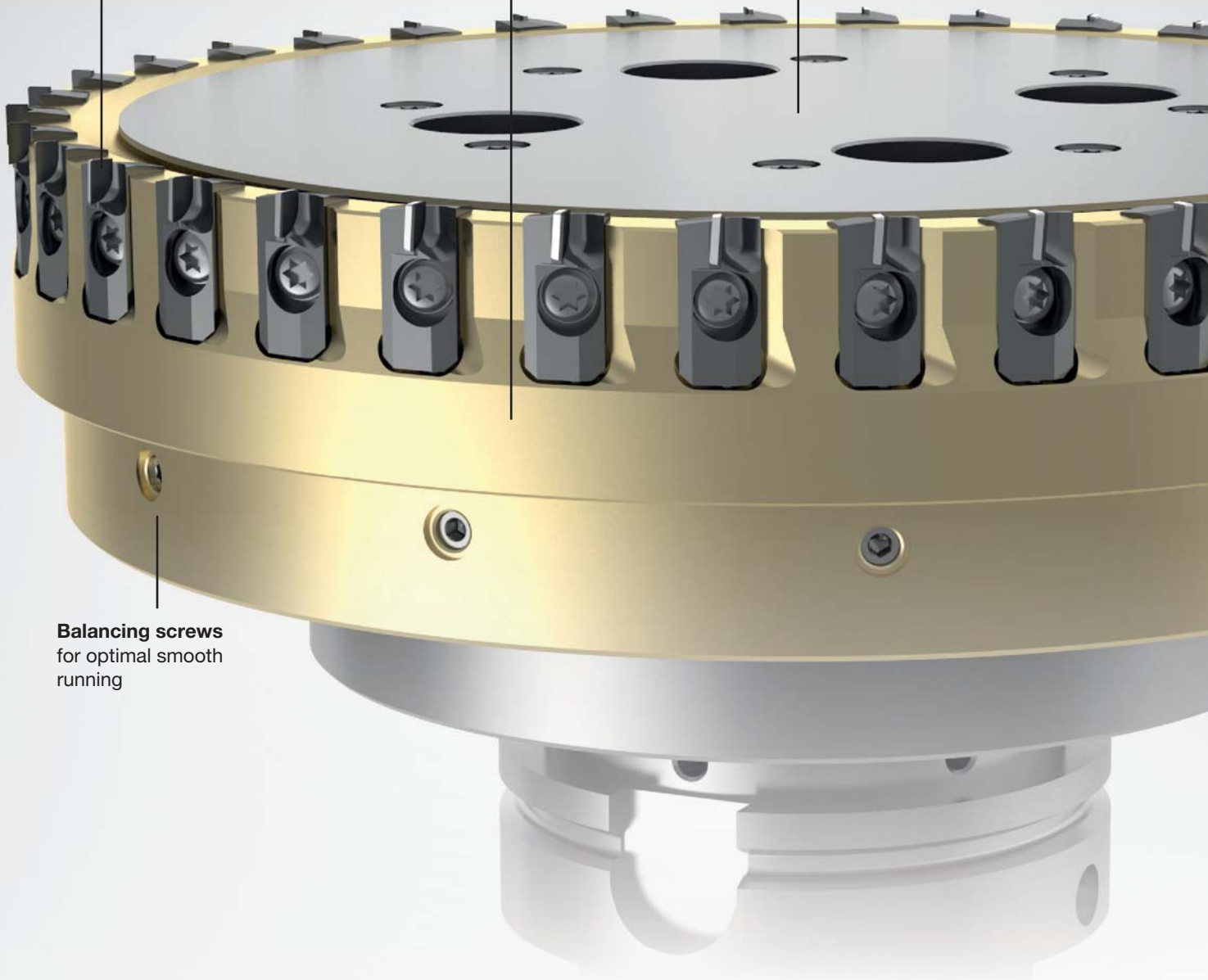

H Holfelder-Gühring

HPC-face mills

extremely high number of cutting edges (i.e. $\varnothing 63 \rightarrow Z=12 / \varnothing 125 \rightarrow Z=27$)

axial run-out of inserts μm -accurately adjustable

PCD inserts and carbide chip guide elements exchangeable

PCD inserts can be re-ground up to 10 times

axial geschlossene Spanräume, keine Späne im Bauteil

Extremely high feed rates (up to 60,000 mm/min)

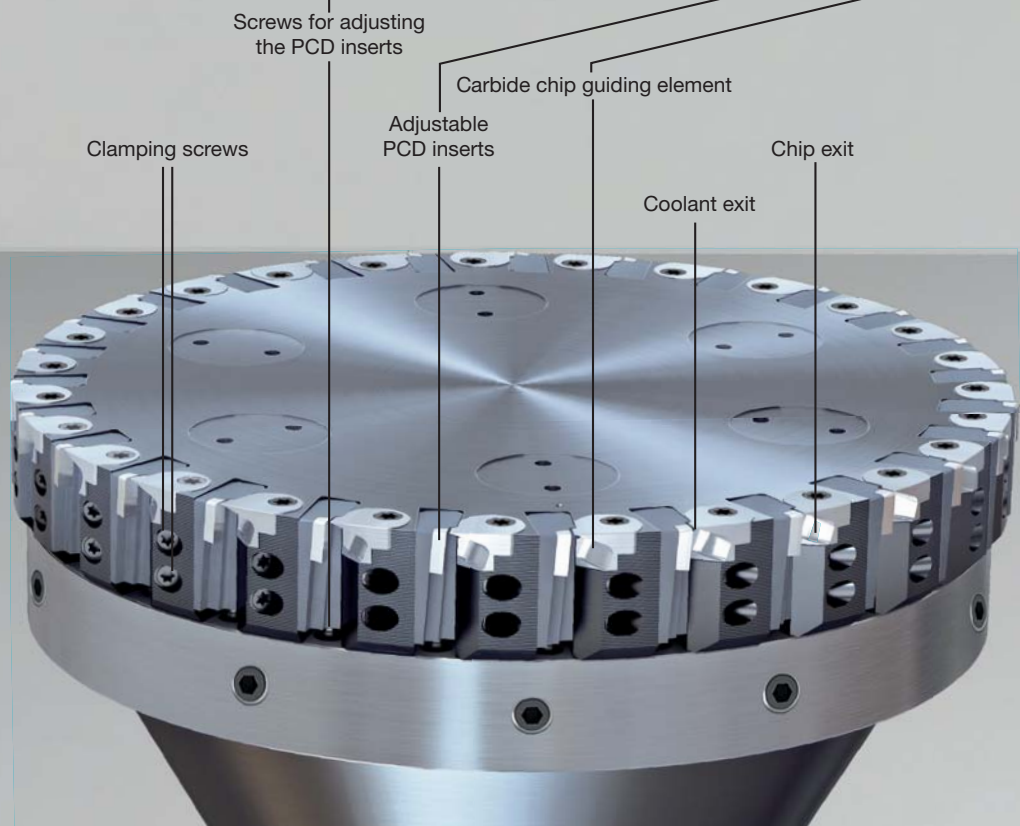
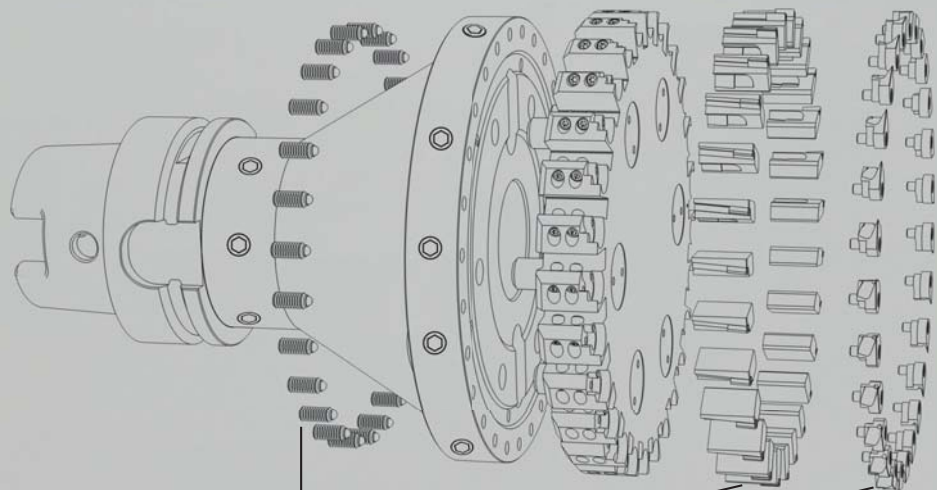

Programme overview:



HPC end mills Art. no. 20004

Standard programme with maximum or reduced number of teeth

for cutting depth up to max. 2 mm

with HSK 63-A / HSK 100-A



End milling cutters Art. no. 20000

axial μm -accurate adjustable

light and medium machining

for nominal diameter 16 - 40 mm

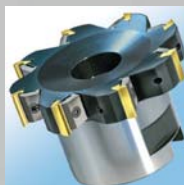

Face milling cutters shell milling cutter Art. no. 20001

axial μm -accurate adjustable

light and medium machining

with maximum or reduced number of teeth, nominal diameter 40 - 160 mm



Face milling cutters monobloc Art. no. 20002

axial μm -accurate adjustable

light and medium machining

with HSK 32 - 100 forme A



Disc milling cutters Art. no. 20003

axial μm -accurate adjustable

Series 3108- and 6120-

for nominal diameter 80 - 200 mm

For more information, see the main
catalogue of Holfelder-Gühring



Advantages at a glance

- ▶ absolutely precise diameter tolerances
- ▶ close radius tolerances
- ▶ radius point grind with constant helix correction
- ▶ cylinder and radius areas ground in one-pass process
- ▶ grinding procedure for highest surface qualities



Seamless
radius area

Optimal
wear-protection

**SOLID CARBIDE
HSC RADIUS MILLING CUTTERS**

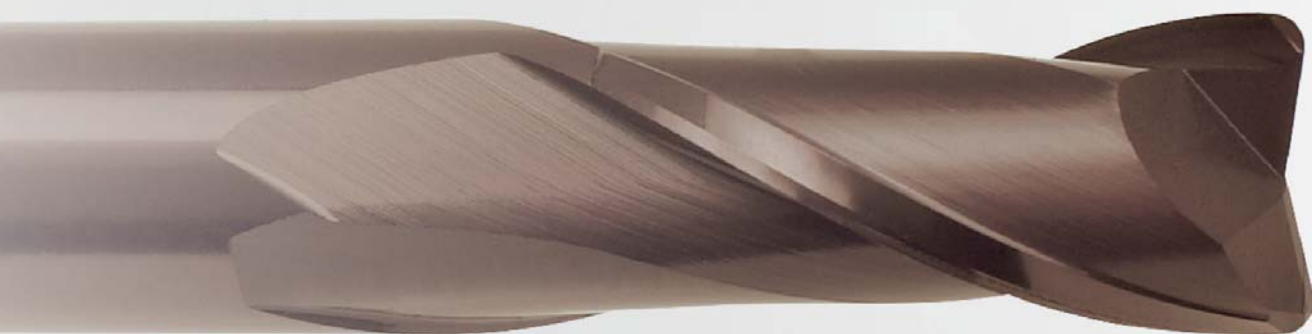

Solid carbide HSC radius
milling cutters

**HSC
VHM**

P	M	K	N	S	H	Tool illustration	Z	Hardness	Shank form	Length	Helix angle °	Tool material	Surface	d1/mm	Article no.	Page
Slot drills with corner radius (2-fluted)																
•	•	•	•	•			2		HA		30°	VHM	○	6.000 - 20.000	3106	176
•	•	•	•	•			2	48 HRC	HA		30°	VHM	⊙	6.000 - 20.000	3561	176
End mills with corner radius (4-fluted)																
•	•	•	•	•	○		4		HA		30°	VHM	○	6.000 - 20.000	3111	177
•	•	•	•	•	○		4	48 HRC	HA		30°	VHM	⊙	6.000 - 20.000	3562	177
Multi-tooth end mills with corner radius GH 100 U																
•	•	•	•	•	○		6+	55 HRC	HA		45°	VHM	⊙	6.000 - 20.000	3563	178
HSC Torus end mills GF 500 T																
•	•	•	○	•	•		2	55 HRC	-HA		30°	VHM	⊙	4.000 - 12.000	3863	179
•	•	•	○	•	•		2	55 HRC	HA		30°	VHM	⊙	0.500 - 12.000	3856	180
•	•	•	○	•	•		2	55 HRC	-HA		30°	VHM	⊙	0.500 - 12.000	3865	181
•	•	•	○	•	•		2	55 HRC	-HA		30°	VHM	⊙	2.000 - 12.000	3859	182
•	•	•	○	•	•		2	55 HRC	-HA		30°	VHM	⊙	2.000 - 8.000	3860	183
•	•	•	○	•	•		4	55 HRC	HA		30°	VHM	⊙	3.000 - 12.000	4268	184
•	•	•	○	•	•		4	55 HRC	Cyl		30°	VHM	⊙	3.000 - 16.000	4269	185
HSC end mills High Feed HF 300																
•	•	•	•	•	•		4	55 HRC	HA		30°	VHM	⊙	3.000 - 16.000	6771	186
•	•	•	•	•	•		4	55 HRC	HA		30°	VHM	⊙	3.000 - 16.000	6772	187
Hard profile cutters with Torus grind GF 300 T																
○	•	•	•	•	•		4	63 HRC	HA		30°	VHM	⊙	1.000 - 16.000	3361	188
○	•	•	•	•	•		4	63 HRC	HA		30°	VHM	⊙	1.000 - 16.000	3362	189
Hard multi-tooth end mills corner radius GH 100 H																
○	•	•	•	•	•		6	63 HRC	HA		55°	VHM	⊙	3.000 - 12.000	4270	190
○	•	•	•	•	•		6	63 HRC	HA		55°	VHM	⊙	6.000 - 16.000	3363	191
Ball nose slot drills (2-fluted)																
•	•	•	•	•	○		2	48 HRC	HA		30°	VHM	⊙	0.500 - 20.000	3679	192

Solid carbide HSC radius milling cutters



P	M	K	N	S	H	Tool illustration	Z	Hardness	Shank form	Length	Helix angle °	Tool material	Surface	d1/mm	Article no.	Page
Ball nose slot drills (2-fluted)																
•	•	•	•	•	○			48 HRC	HB			VHM	F	0.500 - 20.000	3049	192
•	•	•	•	•	○				HB			VHM	○	3.000 - 20.000	3024	193
•	•	•	•	•	○				HA			VHM	○	0.500 - 20.000	3308	194
Ball nose end mills (4-fluted)																
•	○	○	○	○	○				HA			VHM	○	4.000 - 20.000	3306	195
•	○	•	○	•	○			48 HRC	HA			VHM	F	4.000 - 20.000	3727	195
•	○	○	○	○	○				HB			VHM	○	3.000 - 20.000	3026	196
•	○	○	○	○	○			48 HRC	HB			VHM	F	3.000 - 20.000	3050	196
XL ball nose slot drills (2-fluted)																
•	•	•	•	•	○				HA			VHM	○	3.000 - 12.000	3014	197
•	•	•	•	•	○			48 HRC	HA			VHM	F	3.000 - 12.000	3030	197
XL ball nose end mills (4-fluted)																
•	○	○	○	○	○				HA			VHM	○	3.000 - 12.000	3015	198
•	○	○	○	○	○			48 HRC	HA			VHM	F	3.000 - 12.000	3043	198
HSC-ball nose end mills GF 500 B																
•	•	•	○	•	•			55 HRC	-HA			VHM	Y	6.000 - 12.000	3854	199
•	•	•	○	•	•			55 HRC	-HA			VHM	Y	4.000 - 12.000	3866	200
•	•	•	○	•	•			55 HRC	-HA			VHM	Y	2.000 - 12.000	3848	201
•	•	•	○	•	•			55 HRC	Cyl			VHM	Y	6.000 - 12.000	3855	202
•	•	•	○	•	•			55 HRC	-HA			VHM	Y	2.000 - 12.000	3849	203
•	•	•	○	•	•			55 HRC	-HA			VHM	Y	2.000 - 8.000	3853	204
•	•	•	○	•	•			55 HRC	HA			VHM	Y	2.000 - 12.000	4248	205
•	•	•	○	•	•			55 HRC	Cyl			VHM	Y	2.000 - 12.000	4249	206
Ball nose end mills GF 200 B																
•	•	•	○	•	•			48 HRC	HA			VHM	F	3.000 - 10.000	3045	207

Solid carbide HSC radius milling cutters

P	M	K	N	S	H	Tool illustration	Z	Hardness	Shank form	Length	Helix angle °	Tool material	Surface	d1/mm	Article no.	Page
Ball nose end mills GF 200 B								63 HRC	HA			VHM	F	3.000 - 10.000	3044	208
Ball nose hard profile cutters GF 300 B								63 HRC	HA			VHM	Y	0.500 - 16.000	3359	209
								63 HRC	HA			VHM	Y	3.000 - 16.000	3360	210
								63 HRC	HA			VHM	Y	2.000 - 12.000	4246	211
								63 HRC	Cyl			VHM	Y	2.000 - 12.000	4247	212
Die sinking cutter holder GF 200 WP									HA				Ni	10.000 - 32.000	1941	213
									HA				Ni	10.000 - 25.000	1942	214
Indexable inserts round								55 HRC				Cermet	○	10.000 - 32.000	1947	215
								55 HRC				VHM	F	10.000 - 32.000	2520	215
Clamping screws for diesinking cutter holders														3.000	1691	216
Torx screwdriver															1612	216

Solid carbide HSC radius milling cutters

Guhring mould and die cutters

GF300 und GF500 Radius and Torus cutters for HSC machining

Torus cutter GF500 T roughing,
finishing & copy milling up to 54 HRC
i.e.: Article no. 3863



Accurate radii

Close radius and diameter tolerances and stable corner radii with constant helix correction

High stability

Stable core and optimised flute geometry

Large reach

Neck clearance ground for larger, collision-free machining depths

Longer tool life
thanks to improved
Signum coating



Radius cutter GF 500 B
copy milling up to 54 HRC
i.e.: Article no. 3866

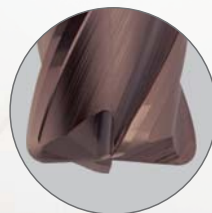

Torus cutter GF 300 T
roughing, finishing & copy
milling from 40-63 HRC
i.e.: Article no. 3361

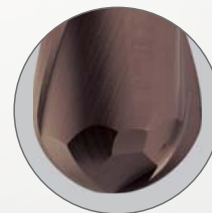

Radius cutter GF 300 B
copy milling from
50-63 HRC
i.e.: Article no. 3359

Slot drills with corner radius (2-fluted)

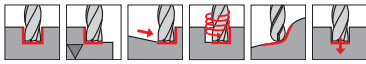

P • **GUHRING NAVIGATOR**
M • Cutting data page 335
K •
N •
S •
H • neck clearance
 • centre cutting

Tool material	Solid carbide	
Surface	○	Ⓡ
Type	N	N
Shank form	HA	HA

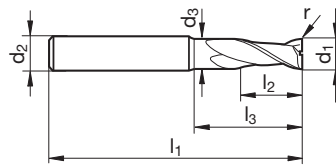

Article no. **3106** **3561**

d1 h10	d2 h6	d3	l1	l2	l3	r	Z	Code no.
mm	mm	mm	mm	mm	mm	mm		
6.00	6.00	5.70	57	10.0	20.0	0.5	2	6.005
6.00	6.00	5.70	57	10.0	20.0	1.0	2	6.010
8.00	8.00	7.70	63	16.0	26.0	0.5	2	8.005
8.00	8.00	7.70	63	16.0	26.0	1.0	2	8.010
8.00	8.00	7.70	63	16.0	26.0	1.5	2	8.015
8.00	8.00	7.70	63	16.0	26.0	2.0	2	8.020
10.00	10.00	9.50	72	19.0	30.0	0.5	2	10.005
10.00	10.00	9.50	72	19.0	30.0	1.0	2	10.010
10.00	10.00	9.50	72	19.0	30.0	1.5	2	10.015
10.00	10.00	9.50	72	19.0	30.0	2.0	2	10.020
12.00	12.00	11.50	83	22.0	36.0	0.5	2	12.005
12.00	12.00	11.50	83	22.0	36.0	1.0	2	12.010
12.00	12.00	11.50	83	22.0	36.0	1.5	2	12.015
12.00	12.00	11.50	83	22.0	36.0	2.0	2	12.020
16.00	16.00	15.50	92	26.0	42.0	1.0	2	16.010
16.00	16.00	15.50	92	26.0	42.0	1.5	2	16.015
16.00	16.00	15.50	92	26.0	42.0	2.0	2	16.020
20.00	20.00	19.50	104	32.0	52.0	1.0	2	20.010
20.00	20.00	19.50	104	32.0	52.0	1.5	2	20.015
20.00	20.00	19.50	104	32.0	52.0	2.0	2	20.020

Solid carbide HSC radius milling cutters

ISO	Hardness	vc	fz (mm/z) / Ø							vc	fz (mm/z) / Ø						
			3	6	8	10	12	16	20		3	6	8	10	12	16	20
P	≤ 850 N/mm ²	120	0,012	0,024	0,032	0,042	0,05	0,07	0,08	140	0,014	0,028	0,037	0,048	0,06	0,08	0,10
	≥ 850 N/mm ²	90	0,011	0,021	0,028	0,039	0,05	0,06	0,08	110	0,012	0,024	0,032	0,045	0,05	0,07	0,09
M	≤ 750 N/mm ²	80	0,008	0,017	0,022	0,030	0,04	0,05	0,06	100	0,010	0,019	0,026	0,035	0,04	0,06	0,07
	≥ 750 N/mm ²	50	0,006	0,013	0,017	0,024	0,03	0,04	0,05	70	0,008	0,015	0,020	0,029	0,03	0,05	0,06
K	≤ 240 HB	110	0,011	0,022	0,030	0,039	0,05	0,06	0,08	130	0,013	0,026	0,034	0,045	0,05	0,07	0,09
N	≥ 7% Si	160	0,016	0,031	0,042	0,056	0,07	0,09	0,11	190	0,018	0,036	0,048	0,064	0,08	0,10	0,13

Please reduce cutting values for bright finish tools: vc -50% and fz -25%



End mills with corner radius (4-fluted)

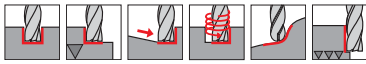

P • **GUHRING NAVIGATOR**
M • Cutting data page 335
K •
N •
S ○
H • neck clearance
 • centre cutting

Tool material	Solid carbide	
Surface	○	●
Type	N	N
Shank form	HA	HA

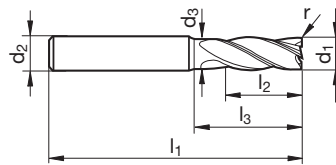

Article no. **3111** **3562**

d1 h10	d2 h6	d3	l1	l2	l3	r	Z	Code no.
mm	mm	mm	mm	mm	mm	mm		
6.00	6.00	5.70	57	13.0	20.0	0.5	4	6.005
6.00	6.00	5.70	57	13.0	20.0	1.0	4	6.010
8.00	8.00	7.70	63	19.0	26.0	0.5	4	8.005
8.00	8.00	7.70	63	19.0	26.0	1.0	4	8.010
8.00	8.00	7.70	63	19.0	26.0	1.5	4	8.015
8.00	8.00	7.70	63	19.0	26.0	2.0	4	8.020
10.00	10.00	9.50	72	22.0	30.0	0.5	4	10.005
10.00	10.00	9.50	72	22.0	30.0	0.8	4	10.008
10.00	10.00	9.50	72	22.0	30.0	1.0	4	10.010
10.00	10.00	9.50	72	22.0	30.0	1.5	4	10.015
10.00	10.00	9.50	72	22.0	30.0	2.0	4	10.020
12.00	12.00	11.50	83	26.0	36.0	0.5	4	12.005
12.00	12.00	11.50	83	26.0	36.0	0.8	4	12.008
12.00	12.00	11.50	83	26.0	36.0	1.0	4	12.010
12.00	12.00	11.50	83	26.0	36.0	1.5	4	12.015
12.00	12.00	11.50	83	26.0	36.0	2.0	4	12.020
16.00	16.00	15.50	92	32.0	42.0	1.0	4	16.010
16.00	16.00	15.50	92	32.0	42.0	1.5	4	16.015
16.00	16.00	15.50	92	32.0	42.0	2.0	4	16.020
20.00	20.00	19.50	104	38.0	52.0	1.0	4	20.010
20.00	20.00	19.50	104	38.0	52.0	1.5	4	20.015
20.00	20.00	19.50	104	38.0	52.0	2.0	4	20.020

Solid carbide HSC radius milling cutters

ISO	Hardness	vc	fz (mm/z) / Ø						vc	fz (mm/z) / Ø							
			3	6	8	10	12	16		20	3	6	8	10	12	16	20
P	≤ 850 N/mm ²	120	0,012	0,024	0,032	0,042	0,05	0,07	0,08	140	0,014	0,028	0,037	0,048	0,06	0,08	0,10
	≥ 850 N/mm ²	90	0,011	0,021	0,028	0,039	0,05	0,06	0,08	110	0,012	0,024	0,032	0,045	0,05	0,07	0,09
M	≤ 750 N/mm ²	80	0,008	0,017	0,022	0,030	0,04	0,05	0,06	100	0,010	0,019	0,026	0,035	0,04	0,06	0,07
	≥ 750 N/mm ²	50	0,006	0,013	0,017	0,024	0,03	0,04	0,05	70	0,008	0,015	0,020	0,029	0,03	0,05	0,06
K	≤ 240 HB	110	0,011	0,022	0,030	0,039	0,05	0,06	0,08	130	0,013	0,026	0,034	0,045	0,05	0,07	0,09
N	≥ 7% Si	160	0,016	0,031	0,042	0,056	0,07	0,09	0,11	190	0,018	0,036	0,048	0,064	0,08	0,10	0,13

Please reduce cutting values for bright finish tools: vc -50% and fz -25%

Multi-tooth end mills with corner radius GH 100 U

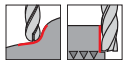
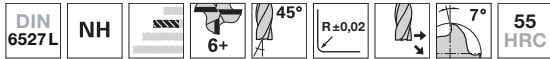

P • **GUHRING NAVIGATOR**
M • Cutting data page 330
K •
N •
S •
H ○ • neck clearance
 • centre cutting

Tool material	Solid carbide
Surface	F
Type	NH
Shank form	HA

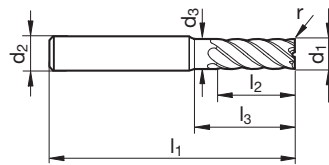

Article no. **3563**

d1 h10	d2 h6	d3	l1	l2	l3	r	Z	Code no.
mm	mm	mm	mm	mm	mm	mm		
6.00	6.00	5.70	57	13.0	20.0	0.5	6	6.005
6.00	6.00	5.70	57	13.0	20.0	1.0	6	6.010
8.00	8.00	7.70	63	19.0	26.0	0.5	6	8.005
8.00	8.00	7.70	63	19.0	26.0	1.0	6	8.010
8.00	8.00	7.70	63	19.0	26.0	1.5	6	8.015
8.00	8.00	7.70	63	19.0	26.0	2.0	6	8.020
10.00	10.00	9.50	72	22.0	30.0	0.5	6	10.005
10.00	10.00	9.50	72	22.0	30.0	1.0	6	10.010
10.00	10.00	9.50	72	22.0	30.0	1.5	6	10.015
10.00	10.00	9.50	72	22.0	30.0	2.0	6	10.020
12.00	12.00	11.50	83	26.0	36.0	0.5	6	12.005
12.00	12.00	11.50	83	26.0	36.0	1.0	6	12.010
12.00	12.00	11.50	83	26.0	36.0	1.5	6	12.015
12.00	12.00	11.50	83	26.0	36.0	2.0	6	12.020
16.00	16.00	15.50	92	32.0	42.0	0.5	6	16.005
16.00	16.00	15.50	92	32.0	42.0	1.0	6	16.010
16.00	16.00	15.50	92	32.0	42.0	1.5	6	16.015
16.00	16.00	15.50	92	32.0	42.0	2.0	6	16.020
20.00	20.00	19.50	104	38.0	52.0	0.5	8	20.005
20.00	20.00	19.50	104	38.0	52.0	1.0	8	20.010
20.00	20.00	19.50	104	38.0	52.0	1.5	8	20.015
20.00	20.00	19.50	104	38.0	52.0	2.0	8	20.020

Solid carbide HSC radius milling cutters

ISO	Hardness	vc	fz (mm/z) / Ø							vc	fz (mm/z) / Ø						
			3	6	8	10	12	16	20		3	6	8	10	12	16	20
P	≤ 850 N/mm ²	220	0,028	0,055	0,074	0,104	0,12	0,17	0,21	240	0,013	0,026	0,035	0,050	0,06	0,08	0,10
	≥ 850 N/mm ²	170	0,026	0,052	0,070	0,097	0,12	0,15	0,19		180	0,013	0,025	0,033	0,046	0,06	0,07
M	≤ 750 N/mm ²	150	0,026	0,052	0,070	0,097	0,12	0,15	0,19	160	0,013	0,025	0,033	0,046	0,06	0,07	0,09
	≥ 750 N/mm ²	70	0,023	0,046	0,061	0,081	0,10	0,13	0,16		80	0,010	0,020	0,026	0,035	0,04	0,06
S	Ni-based	40	0,017	0,035	0,046	0,069	0,08	0,11	0,14	40	0,008	0,015	0,020	0,030	0,04	0,05	0,06
	Ti-based	70	0,023	0,046	0,061	0,087	0,10	0,14	0,17		80	0,011	0,022	0,029	0,042	0,05	0,07
K	≤ 240 HB	190	0,028	0,055	0,074	0,104	0,12	0,17	0,21	210	0,013	0,026	0,035	0,050	0,06	0,08	0,10
	≥ 240 HB	170	0,026	0,052	0,070	0,097	0,12	0,15	0,19		180	0,013	0,025	0,033	0,046	0,06	0,07



HSC Torus end mills GF 500 T

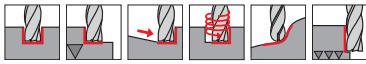
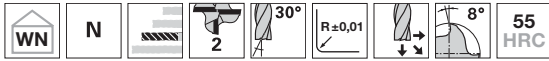

- P** • **GUHRING NAVIGATOR**
 - M** • Cutting data page 333
 - K** •
 - N** ○
 - S** •
 - H** •
- centre cutting

Tool material	Solid carbide
Surface	Y
Type	N
Shank form	HA

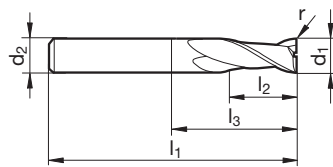

Article no. **3863**

d1 e8	d2 h6	l1	l2	l3	r	Z	Code no.
mm	mm	mm	mm	mm	mm		
4.00	4.00	80	8.0	12.5	0.5	2	4.000
6.00	6.00	100	12.0	19.0	1.0	2	6.000
8.00	8.00	100	16.0	24.0	1.0	2	8.000
10.00	10.00	100	20.0	30.0	1.0	2	10.000
12.00	12.00	120	24.0	37.0	1.5	2	12.000

ISO	Hardness	vc	fz (mm/z) / Ø							vc	fz (mm/z) / Ø						
			2	3	4	6	8	10	12		2	3	4	6	8	10	12
P	≤ 850 N/mm ²	180	0,023	0,034	0,045	0,068	0,090	0,113	0,135	270	0,016	0,024	0,032	0,047	0,063	0,079	0,095
	≥ 850 N/mm ²	150	0,018	0,027	0,036	0,054	0,072	0,090	0,108		230	0,013	0,019	0,025	0,038	0,050	0,063
H	≤ 55 HRC	90	0,018	0,027	0,036	0,054	0,072	0,090	0,108	150	0,013	0,019	0,025	0,038	0,050	0,063	0,076
M	≤ 750 N/mm ²	120	0,020	0,029	0,039	0,049	0,059	0,078	0,098	180	0,014	0,020	0,027	0,041	0,055	0,068	0,082
	≥ 750 N/mm ²	60	0,015	0,023	0,030	0,045	0,060	0,075	0,090		100	0,010	0,015	0,020	0,029	0,039	0,049
S	Ni-based	40	0,015	0,023	0,030	0,045	0,060	0,075	0,090	60	0,010	0,015	0,020	0,029	0,039	0,049	0,059
	Ti-based	75	0,018	0,027	0,036	0,054	0,072	0,090	0,108		120	0,013	0,019	0,025	0,038	0,050	0,063
K	≤ 240 HB	165	0,023	0,034	0,045	0,068	0,090	0,113	0,135	250	0,016	0,024	0,032	0,047	0,063	0,079	0,095
	≥ 240 HB	135	0,020	0,029	0,039	0,059	0,078	0,098	0,117		210	0,014	0,020	0,027	0,041	0,055	0,068
N	≥ 7 % Si	225	0,023	0,034	0,045	0,068	0,090	0,113	0,135	380	0,016	0,024	0,032	0,047	0,063	0,079	0,095

Solid carbide HSC radius milling cutters

HSC Torus end mills GF 500 T

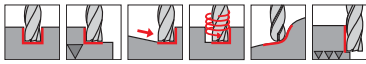
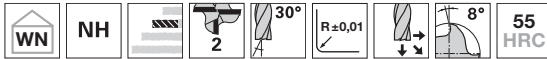

P • **GUHRING NAVIGATOR**
M • Cutting data page 333
K •
N ○
S •
H •

- neck clearance
- centre cutting

Tool material	Solid carbide
Surface	Y
Type	NH
Shank form	HA

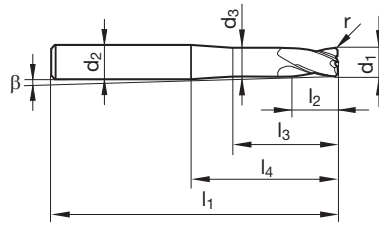

Article no. 3856

d1 e8	d2 h6	d3	l1	l2	l3	l4	r	β	Z	Code no.
mm	mm	mm	mm	mm	mm	mm	mm	°		
0.50	4.00	0.48	50	1.0	3.0	20.0	0.10	4.60	2	0.501
1.00	4.00	0.95	50	2.0	6.0	20.0	0.20	4.00	2	1.002
2.00	6.00	1.90	57	3.0	8.0	21.0	0.50	5.60	2	2.000
2.00	6.00	1.90	57	3.0	8.0	21.0	0.20	5.50	2	2.002
3.00	6.00	2.80	57	3.5	14.0	21.0	0.50	4.20	2	3.000
4.00	6.00	3.80	57	4.0	16.0	21.0	1.00	2.90	2	4.000
4.00	6.00	3.80	57	4.0	16.0	21.0	0.30	2.80	2	4.003
4.00	6.00	3.80	57	4.0	16.0	21.0	0.50	2.80	2	4.005
5.00	6.00	4.80	57	5.0	18.0	21.0	0.50	1.40	2	5.005
5.00	6.00	4.80	57	5.0	18.0	21.0	1.00	1.50	2	5.010
6.00	6.00	5.70	57	6.0	20.0	21.0	2.00		2	6.000
6.00	6.00	5.70	57	6.0	20.0	21.0	0.50		2	6.005
6.00	6.00	5.70	57	6.0	20.0	21.0	1.00		2	6.010
6.00	6.00	5.70	57	6.0	20.0	21.0	1.50		2	6.015
8.00	8.00	7.70	63	8.0	26.0	27.0	2.00		2	8.000
8.00	8.00	7.70	63	8.0	26.0	27.0	0.50		2	8.005
8.00	8.00	7.70	63	8.0	26.0	27.0	1.00		2	8.010
10.00	10.00	9.50	72	10.0	30.0	32.0	3.00		2	10.000
10.00	10.00	9.50	72	10.0	30.0	32.0	0.50		2	10.005
10.00	10.00	9.50	72	10.0	30.0	32.0	1.50		2	10.015
12.00	12.00	11.50	83	12.0	36.0	38.0	4.00		2	12.000
12.00	12.00	11.50	83	12.0	36.0	38.0	2.00		2	12.020

Solid carbide HSC radius milling cutters

ISO	Hardness	vc	fz (mm/z) / Ø								vc	fz (mm/z) / Ø							
			2	3	4	6	8	10	12	2		3	4	6	8	10	12		
P	≤ 850 N/mm ²	240	0,030	0,045	0,060	0,090	0,120	0,150	0,180		360	0,021	0,032	0,042	0,063	0,084	0,105	0,126	
	≥ 850 N/mm ²	200	0,024	0,036	0,048	0,072	0,096	0,120	0,144			300	0,017	0,025	0,034	0,050	0,067	0,084	0,101
H	≤ 55 HRC	120	0,024	0,036	0,048	0,072	0,096	0,120	0,144	200	0,017	0,025	0,034	0,050	0,067	0,084	0,101		
M	≤ 750 N/mm ²	160	0,026	0,039	0,052	0,078	0,104	0,130	0,156		240	0,018	0,027	0,036	0,055	0,073	0,091	0,109	
	≥ 750 N/mm ²	80	0,020	0,030	0,040	0,060	0,080	0,100	0,120			130	0,013	0,020	0,026	0,039	0,052	0,065	0,078
S	Ni-based	45	0,020	0,030	0,040	0,060	0,080	0,100	0,120		80	0,013	0,020	0,026	0,039	0,052	0,065	0,078	
	Ti-based	100	0,024	0,036	0,048	0,072	0,096	0,120	0,144			150	0,017	0,025	0,034	0,050	0,067	0,084	0,101
K	≤ 240 HB	220	0,030	0,045	0,060	0,090	0,120	0,150	0,180		330	0,021	0,032	0,042	0,063	0,084	0,105	0,126	
	≥ 240 HB	180	0,026	0,039	0,052	0,078	0,104	0,130	0,156			270	0,018	0,027	0,036	0,055	0,073	0,091	0,109
N	≥ 7 % Si	300	0,030	0,045	0,060	0,090	0,120	0,150	0,180	500	0,021	0,032	0,042	0,063	0,084	0,105	0,126		



HSC Torus end mills GF 500 T

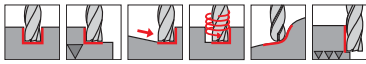
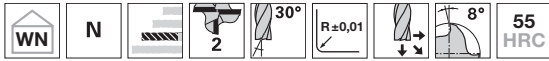

P • **GUHRING NAVIGATOR**
M • Cutting data page 333
K •
N ○
S •
H •

- neck clearance
- centre cutting

Tool material	Solid carbide
Surface	Y
Type	N
Shank form	HA

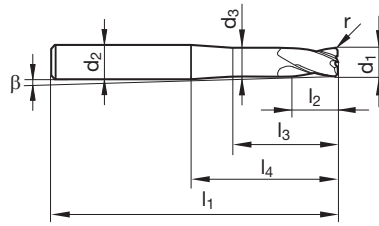

Article no. **3865**

d1 e8	d2 h6	d3	l1	l2	l3	l4	r	β	Z	Code no.
mm	mm	mm	mm	mm	mm	mm	mm	°		
0.50	4.00	0.48	50	1.0	6.0	20.0	0.10	5.10	2	0.500
1.00	4.00	0.95	50	2.0	12.0	20.0	0.20	4.40	2	1.002
2.00	6.00	1.90	75	3.0	18.0	35.0	0.20	3.30	2	2.002
2.00	6.00	1.90	75	3.0	18.0	35.0	0.50	3.40	2	2.005
3.00	6.00	2.80	80	3.5	25.0	40.0	0.50	2.20	2	3.005
4.00	6.00	3.80	80	4.0	32.0	40.0	0.30	1.50	2	4.003
4.00	6.00	3.80	80	4.0	32.0	40.0	0.50	1.50	2	4.005
5.00	6.00	4.80	80	5.0	39.0	40.0	0.50	0.80	2	5.005
5.00	6.00	4.80	80	5.0	39.0	40.0	1.00	0.80	2	5.010
6.00	6.00	5.70	80	6.0	39.0	40.0	2.00		2	6.000
6.00	6.00	5.70	80	6.0	39.0	40.0	0.50		2	6.005
6.00	6.00	5.70	80	6.0	39.0	40.0	1.00		2	6.010
6.00	6.00	5.70	80	6.0	39.0	40.0	1.50		2	6.015
8.00	8.00	7.70	100	8.0	59.0	60.0	2.00		2	8.000
8.00	8.00	7.70	100	8.0	59.0	60.0	0.50		2	8.005
8.00	8.00	7.70	100	8.0	59.0	60.0	1.00		2	8.010
10.00	10.00	9.50	120	10.0	73.0	75.0	3.00		2	10.000
10.00	10.00	9.50	120	10.0	73.0	75.0	0.50		2	10.005
10.00	10.00	9.50	120	10.0	73.0	75.0	1.00		2	10.010
10.00	10.00	9.50	120	10.0	73.0	75.0	2.00		2	10.020
12.00	12.00	11.50	120	12.0	73.0	75.0	4.00		2	12.000
12.00	12.00	11.50	120	12.0	73.0	75.0	2.00		2	12.020

Solid carbide HSC radius milling cutters

ISO	Hardness	vc	fz (mm/z) / Ø							vc	fz (mm/z) / Ø						
			2	3	4	6	8	10	12		2	3	4	6	8	10	12
P	≤ 850 N/mm ²	120	0,015	0,023	0,030	0,045	0,060	0,075	0,090	180	0,011	0,016	0,021	0,032	0,042	0,053	0,063
	≥ 850 N/mm ²	100	0,012	0,018	0,024	0,036	0,048	0,060	0,072		150	0,008	0,013	0,017	0,025	0,034	0,042
H	≤ 55 HRC	60	0,012	0,018	0,024	0,036	0,048	0,060	0,072	100	0,008	0,013	0,017	0,025	0,034	0,042	0,050
M	≤ 750 N/mm ²	80	0,013	0,020	0,026	0,033	0,039	0,052	0,065	120	0,009	0,014	0,018	0,027	0,036	0,046	0,055
	≥ 750 N/mm ²	40	0,010	0,015	0,020	0,030	0,040	0,050	0,060		70	0,007	0,010	0,013	0,020	0,026	0,033
S	Ni-based	30	0,010	0,015	0,020	0,030	0,040	0,050	0,060	40	0,007	0,010	0,013	0,020	0,026	0,033	0,039
	Ti-based	50	0,012	0,018	0,024	0,036	0,048	0,060	0,072		80	0,008	0,013	0,017	0,025	0,034	0,042
K	≤ 240 HB	110	0,015	0,023	0,030	0,045	0,060	0,075	0,090	170	0,011	0,016	0,021	0,032	0,042	0,053	0,063
	≥ 240 HB	90	0,013	0,020	0,026	0,039	0,052	0,065	0,078		140	0,009	0,014	0,018	0,027	0,036	0,046
N	≥ 7 % Si	150	0,015	0,023	0,030	0,045	0,060	0,075	0,090	250	0,011	0,016	0,021	0,032	0,042	0,053	0,063

HSC Torus end mills GF 500 T

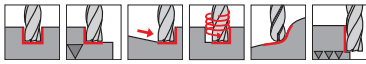
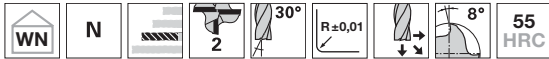

- P** • **GUHRING NAVIGATOR**
- M** • Cutting data page 333
- K** •
- N** ○
- S** •
- H** •
 - neck clearance
 - centre cutting

Tool material	Solid carbide
Surface	Y
Type	N
Shank form	HA

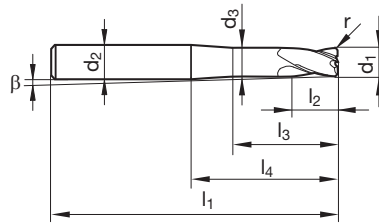

Article no. **3859**

d1 e8	d2 h6	d3	l1	l2	l3	l4	r	β	Z	Code no.
mm	mm	mm	mm	mm	mm	mm	mm	°		
2.00	6.00	1.80	80	3.0	8.0	40.0	0.50	2.90	2	2.000
3.00	6.00	2.80	80	3.5	12.0	40.0	0.50	2.20	2	3.000
4.00	6.00	3.80	80	4.0	20.0	40.0	1.00	1.50	2	4.000
6.00	8.00	5.60	100	6.0	25.0	60.0	2.00	1.00	2	6.000
8.00	10.00	7.60	120	7.0	30.0	75.0	2.00	0.80	2	8.000
10.00	12.00	9.60	120	8.0	30.0	70.0	3.00	0.90	2	10.000
12.00	16.00	11.50	150	10.0	35.0	100.0	4.00	1.20	2	12.000

Solid carbide HSC radius milling cutters

ISO	Hardness	vc	fz (mm/z) / Ø							vc	fz (mm/z) / Ø						
			2	3	4	6	8	10	12		2	3	4	6	8	10	12
P	≤ 850 N/mm ²	120	0,015	0,023	0,030	0,045	0,060	0,075	0,090	180	0,011	0,016	0,021	0,032	0,042	0,053	0,063
	≥ 850 N/mm ²	100	0,012	0,018	0,024	0,036	0,048	0,060	0,072		150	0,008	0,013	0,017	0,025	0,034	0,042
H	≤ 55 HRC	60	0,012	0,018	0,024	0,036	0,048	0,060	0,072	100	0,008	0,013	0,017	0,025	0,034	0,042	0,050
M	≤ 750 N/mm ²	80	0,013	0,020	0,026	0,033	0,039	0,052	0,065	120	0,009	0,014	0,018	0,027	0,036	0,046	0,055
	≥ 750 N/mm ²	40	0,010	0,015	0,020	0,030	0,040	0,050	0,060		70	0,007	0,010	0,013	0,020	0,026	0,033
S	Ni-based	30	0,010	0,015	0,020	0,030	0,040	0,050	0,060	40	0,007	0,010	0,013	0,020	0,026	0,033	0,039
	Ti-based	50	0,012	0,018	0,024	0,036	0,048	0,060	0,072		80	0,008	0,013	0,017	0,025	0,034	0,042
K	≤ 240 HB	110	0,015	0,023	0,030	0,045	0,060	0,075	0,090	170	0,011	0,016	0,021	0,032	0,042	0,053	0,063
	≥ 240 HB	90	0,013	0,020	0,026	0,039	0,052	0,065	0,078		140	0,009	0,014	0,018	0,027	0,036	0,046
N	≥ 7 % Si	150	0,015	0,023	0,030	0,045	0,060	0,075	0,090	250	0,011	0,016	0,021	0,032	0,042	0,053	0,063



HSC Torus end mills GF 500 T

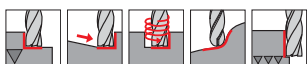
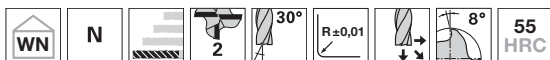

P • **GUHRING NAVIGATOR**
M • Cutting data page 333
K •
N ○
S •
H •

- neck clearance
- centre cutting

Tool material	Solid carbide
Surface	Y
Type	N
Shank form	HA

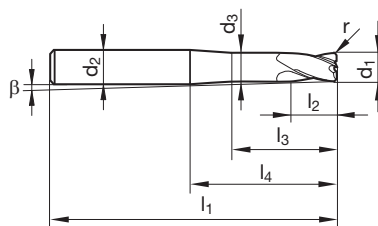

Article no. **3860**

d1 e8	d2 h6	d3	l1	l2	l3	l4	r	β	Z	Code no.
mm	mm	mm	mm	mm	mm	mm	mm	°		
2.00	6.00	1.80	80	3.0	8.0	40.0	0.50	2.90	2	2.000
3.00	6.00	2.80	80	3.5	12.0	45.0	0.50	2.00	2	3.000
4.00	6.00	3.80	100	4.0	20.0	60.0	0.50	1.00	2	4.000
6.00	8.00	5.60	120	6.0	25.0	80.0	1.00	0.80	2	6.000
8.00	10.00	7.60	150	7.0	20.0	105.0	1.00	0.60	2	8.000

ISO	Hardness	vc	fz (mm/z) / Ø							vc	fz (mm/z) / Ø						
			2	3	4	6	8	10	12		2	3	4	6	8	10	12
P	≤ 850 N/mm ²	120	0,015	0,023	0,030	0,045	0,060	0,075	0,090	180	0,011	0,016	0,021	0,032	0,042	0,053	0,063
	≥ 850 N/mm ²	100	0,012	0,018	0,024	0,036	0,048	0,060	0,072		150	0,008	0,013	0,017	0,025	0,034	0,042
H	≤ 55 HRC	60	0,012	0,018	0,024	0,036	0,048	0,060	0,072	100	0,008	0,013	0,017	0,025	0,034	0,042	0,050
M	≤ 750 N/mm ²	80	0,013	0,020	0,026	0,033	0,039	0,052	0,065	120	0,009	0,014	0,018	0,027	0,036	0,046	0,055
	≥ 750 N/mm ²	40	0,010	0,015	0,020	0,030	0,040	0,050	0,060		70	0,007	0,010	0,013	0,020	0,026	0,033
S	Ni-based	30	0,010	0,015	0,020	0,030	0,040	0,050	0,060	40	0,007	0,010	0,013	0,020	0,026	0,033	0,039
	Ti-based	50	0,012	0,018	0,024	0,036	0,048	0,060	0,072		80	0,008	0,013	0,017	0,025	0,034	0,042
K	≤ 240 HB	110	0,015	0,023	0,030	0,045	0,060	0,075	0,090	170	0,011	0,016	0,021	0,032	0,042	0,053	0,063
	≥ 240 HB	90	0,013	0,020	0,026	0,039	0,052	0,065	0,078		140	0,009	0,014	0,018	0,027	0,036	0,046
N	≥ 7 % Si	150	0,015	0,023	0,030	0,045	0,060	0,075	0,090	250	0,011	0,016	0,021	0,032	0,042	0,053	0,063

Solid carbide HSC radius milling cutters

HSC Torus end mills GF 500 T

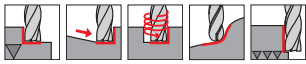
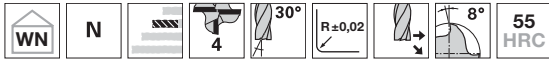

P • **GUHRING NAVIGATOR**
M • Cutting data page 333
K •
N ○
S •
H •

- neck clearance
- centre cutting

Tool material	Solid carbide
Surface	Y
Type	N
Shank form	HA

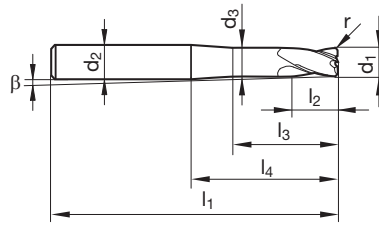

Article no. **4268**

d1 e8	d2 h6	d3	l1	l2	l3	l4	r	β	Z	Code no.
mm	mm	mm	mm	mm	mm	mm	mm	°		
3.00	6.00	2.80	57	3.5	14.0	21.0	0.30	4.20	4	3.003
3.00	6.00	2.80	57	3.5	14.0	21.0	0.50	4.20	4	3.005
4.00	6.00	3.80	57	4.0	16.0	21.0	0.30	2.80	4	4.003
4.00	6.00	3.80	57	4.0	16.0	21.0	0.50	2.80	4	4.005
5.00	6.00	4.80	57	5.0	18.0	21.0	0.30	1.40	4	5.003
5.00	6.00	4.80	57	5.0	18.0	21.0	0.50	1.40	4	5.005
6.00	6.00	5.70	57	6.0	20.0	21.0	0.30		4	6.003
6.00	6.00	5.70	57	6.0	20.0	21.0	0.50		4	6.005
6.00	6.00	5.70	57	6.0	20.0	21.0	1.00		4	6.010
6.00	6.00	5.70	57	6.0	20.0	21.0	1.50		4	6.015
8.00	8.00	7.70	63	8.0	26.0	27.0	0.50		4	8.005
8.00	8.00	7.70	63	8.0	26.0	27.0	1.00		4	8.010
8.00	8.00	7.70	63	8.0	26.0	27.0	1.50		4	8.015
8.00	8.00	7.70	63	8.0	26.0	27.0	2.00		4	8.020
10.00	10.00	9.50	72	10.0	30.0	32.0	0.50		4	10.005
10.00	10.00	9.50	72	10.0	30.0	32.0	1.00		4	10.010
10.00	10.00	9.50	72	10.0	30.0	32.0	1.50		4	10.015
10.00	10.00	9.50	72	10.0	30.0	32.0	2.00		4	10.020
12.00	12.00	11.50	83	12.0	36.0	38.0	0.50		4	12.005
12.00	12.00	11.50	83	12.0	36.0	38.0	1.00		4	12.010
12.00	12.00	11.50	83	12.0	36.0	38.0	1.50		4	12.015
16.00	16.00	15.50	92	16.0	42.0	44.0	2.00		4	16.020
16.00	16.00	15.50	92	16.0	42.0	44.0	3.00		4	16.030

Solid carbide HSC radius milling cutters

ISO	Hardness	vc	fz (mm/z) / Ø							vc	fz (mm/z) / Ø						
			2	3	4	6	8	10	12		2	3	4	6	8	10	12
P	≤ 850 N/mm ²	240	0,030	0,045	0,060	0,090	0,120	0,150	0,180	360	0,021	0,032	0,042	0,063	0,084	0,105	0,126
	≥ 850 N/mm ²	200	0,024	0,036	0,048	0,072	0,096	0,120	0,144		300	0,017	0,025	0,034	0,050	0,067	0,084
H	≤ 55 HRC	120	0,024	0,036	0,048	0,072	0,096	0,120	0,144	200	0,017	0,025	0,034	0,050	0,067	0,084	0,101
M	≤ 750 N/mm ²	160	0,026	0,039	0,052	0,078	0,104	0,130	0,156	240	0,018	0,027	0,036	0,055	0,073	0,091	0,109
	≥ 750 N/mm ²	80	0,020	0,030	0,040	0,060	0,080	0,100	0,120		130	0,013	0,020	0,026	0,039	0,052	0,065
S	Ni-based	45	0,020	0,030	0,040	0,060	0,080	0,100	0,120	80	0,013	0,020	0,026	0,039	0,052	0,065	0,078
	Ti-based	100	0,024	0,036	0,048	0,072	0,096	0,120	0,144		150	0,017	0,025	0,034	0,050	0,067	0,084
K	≤ 240 HB	220	0,030	0,045	0,060	0,090	0,120	0,150	0,180	330	0,021	0,032	0,042	0,063	0,084	0,105	0,126
	≥ 240 HB	180	0,026	0,039	0,052	0,078	0,104	0,130	0,156		270	0,018	0,027	0,036	0,055	0,073	0,091
N	≥ 7 % Si	300	0,030	0,045	0,060	0,090	0,120	0,150	0,180	500	0,021	0,032	0,042	0,063	0,084	0,105	0,126



HSC Torus end mills GF 500 T

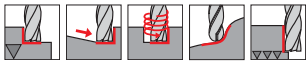
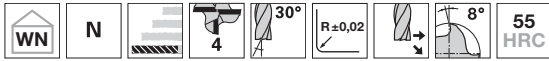

P • **GUHRING NAVIGATOR**
M • Cutting data page 333
K •
N ○
S •
H •

- neck clearance
- centre cutting

Tool material	Solid carbide
Surface	Y
Type	N
Shank form	cyl.

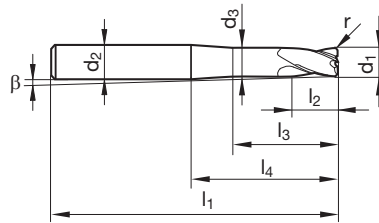

Article no. **4269**

d1 e8	d2 h6	d3	l1	l2	l3	l4	r	β	Z	Code no.
mm	mm	mm	mm	mm	mm	mm	mm	°		
3.00	6.00	2.80	80	3.5	25.0	40.0	0.30	2.20	4	3.003
3.00	6.00	2.80	80	3.5	25.0	40.0	0.50	2.20	4	3.005
4.00	6.00	3.80	80	4.0	32.0	40.0	0.30	1.50	4	4.003
4.00	6.00	3.80	80	4.0	32.0	40.0	0.50	1.50	4	4.005
5.00	6.00	4.80	80	5.0	39.0	40.0	0.30	0.80	4	5.003
6.00	6.00	5.70	80	6.0	39.0	40.0	0.30		4	6.003
6.00	6.00	5.70	80	6.0	39.0	40.0	0.50		4	6.005
6.00	6.00	5.70	80	6.0	39.0	40.0	1.00		4	6.010
6.00	6.00	5.70	80	6.0	39.0	40.0	1.50		4	6.015
8.00	8.00	7.70	100	8.0	59.0	60.0	0.50		4	8.005
8.00	8.00	7.70	100	8.0	59.0	60.0	1.00		4	8.010
8.00	8.00	7.70	100	8.0	59.0	60.0	2.00		4	8.020
10.00	10.00	9.50	120	10.0	73.0	75.0	0.50		4	10.005
10.00	10.00	9.50	120	10.0	73.0	75.0	1.00		4	10.010
10.00	10.00	9.50	120	10.0	73.0	75.0	2.00		4	10.020
12.00	12.00	11.50	120	12.0	73.0	75.0	0.50		4	12.005
12.00	12.00	11.50	120	12.0	73.0	75.0	1.00		4	12.010
12.00	12.00	11.50	120	12.0	73.0	75.0	1.50		4	12.015
12.00	12.00	11.50	120	12.0	73.0	75.0	2.00		4	12.020
16.00	16.00	15.50	150	16.0	98.0	100.0	2.00		4	16.020
16.00	16.00	15.50	150	16.0	98.0	100.0	3.00		4	16.030

Solid carbide HSC radius milling cutters

ISO	Hardness	vc	fz (mm/z) / Ø							vc	fz (mm/z) / Ø							
			2	3	4	6	8	10	12		2	3	4	6	8	10	12	
P	≤ 850 N/mm ²	120	0,015	0,023	0,030	0,045	0,060	0,075	0,090		180	0,011	0,016	0,021	0,032	0,042	0,053	0,063
	≥ 850 N/mm ²	100	0,012	0,018	0,024	0,036	0,048	0,060	0,072		150	0,008	0,013	0,017	0,025	0,034	0,042	0,050
H	≤ 55 HRC	60	0,012	0,018	0,024	0,036	0,048	0,060	0,072	100	0,008	0,013	0,017	0,025	0,034	0,042	0,050	
M	≤ 750 N/mm ²	80	0,013	0,020	0,026	0,033	0,039	0,052	0,065		120	0,009	0,014	0,018	0,027	0,036	0,046	0,055
	≥ 750 N/mm ²	40	0,010	0,015	0,020	0,030	0,040	0,050	0,060		70	0,007	0,010	0,013	0,020	0,026	0,033	0,039
S	Ni-based	30	0,010	0,015	0,020	0,030	0,040	0,050	0,060		40	0,007	0,010	0,013	0,020	0,026	0,033	0,039
	Ti-based	50	0,012	0,018	0,024	0,036	0,048	0,060	0,072		80	0,008	0,013	0,017	0,025	0,034	0,042	0,050
K	≤ 240 HB	110	0,015	0,023	0,030	0,045	0,060	0,075	0,090		170	0,011	0,016	0,021	0,032	0,042	0,053	0,063
	≥ 240 HB	90	0,013	0,020	0,026	0,039	0,052	0,065	0,078		140	0,009	0,014	0,018	0,027	0,036	0,046	0,055
N	≥ 7 % Si	150	0,015	0,023	0,030	0,045	0,060	0,075	0,090	250	0,011	0,016	0,021	0,032	0,042	0,053	0,063	

HSC end mills High Feed HF 300

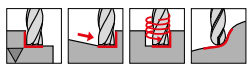

P • **GUHRING NAVIGATOR**

M • Cutting data page 334

K •

N • for HSC roughing with low ap and maximum fz

S • material groups M / S require cooling when milling

H • with internal cooling > Ø 5 mm

• neck clearance

• without centre cutting

Tool material	Solid carbide
Surface	Y
Type	H
Shank form	HA

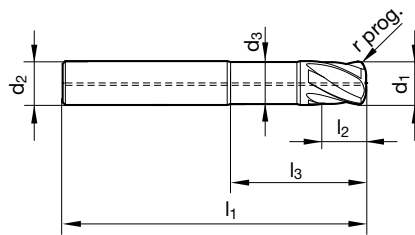

Article no. **6771**

d1 h10	d2 h6	d3	l1	l2	l3	r prog.	Z	Code no.
mm	mm	mm	mm	mm	mm	mm		
3.00	6.00	2.80	57	2.0	15.0	0.5	4	3.000
4.00	6.00	3.80	57	3.0	18.0	0.8	4	4.000
5.00	6.00	4.80	57	4.0	20.0	0.8	4	5.000
6.00	6.00	5.70	57	5.0	20.0	1.0	4	6.000
8.00	8.00	7.70	63	6.0	26.0	1.5	4	8.000
10.00	10.00	9.50	72	8.0	30.0	2.0	4	10.000
12.00	12.00	11.50	83	10.0	36.0	2.0	4	12.000
16.00	16.00	15.50	92	12.0	42.0	2.5	4	16.000

Solid carbide HSC radius milling cutters

ISO	Hardness	vc	fz (mm/z) / Ø								ap max							
			3	4	5	8	8	10	12	16	3	4	5	8	8	10	12	16
P	≤ 850 N/mm ²	250	0,13	0,17	0,21	0,29	0,38	0,48	0,58	0,77	0,18	0,24	0,30	0,36	0,48	0,60	0,72	0,96
	≥ 850 N/mm ²	170	0,09	0,12	0,15	0,22	0,29	0,36	0,43	0,58	0,15	0,20	0,25	0,30	0,40	0,50	0,60	0,80
K	≤ 240 HB	220	0,11	0,14	0,18	0,25	0,34	0,42	0,50	0,67	0,18	0,24	0,30	0,36	0,48	0,60	0,72	0,96
	≥ 240 HB	180	0,10	0,13	0,16	0,23	0,31	0,38	0,46	0,61	0,15	0,20	0,25	0,30	0,40	0,50	0,60	0,80
H	≤ 55 HRC	120	0,07	0,10	0,12	0,18	0,24	0,30	0,36	0,48	0,12	0,16	0,20	0,24	0,32	0,40	0,48	0,64
	55 - 63 HRC	90	0,04	0,05	0,06	0,11	0,14	0,18	0,22	0,29	0,10	0,12	0,15	0,18	0,24	0,30	0,36	0,48
M	≤ 850 N/mm ²	130	0,11	0,14	0,18	0,25	0,34	0,42	0,50	0,67	0,12	0,16	0,20	0,24	0,32	0,40	0,48	0,64
	≥ 850 N/mm ²	70	0,07	0,10	0,12	0,18	0,24	0,30	0,36	0,48	0,10	0,12	0,15	0,18	0,24	0,30	0,36	0,48
S	Ti	60	0,07	0,10	0,12	0,18	0,24	0,30	0,36	0,48	0,10	0,12	0,15	0,18	0,24	0,30	0,36	0,48



HSC end mills High Feed HF 300

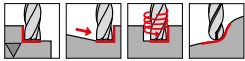

P • **GUHRING NAVIGATOR**

M • Cutting data page 334

K •

N •

S •

H •

- for HSC roughing with low ap and maximum fz
- material groups M / S require cooling when milling
- with internal cooling > Ø 5 mm
- neck clearance
- without centre cutting

Tool material	Solid carbide
Surface	Y
Type	H
Shank form	HA

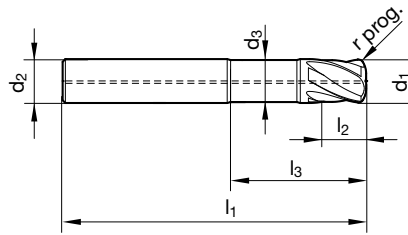

Article no. **6772**

d1 h10	d2 h6	d3	l1	l2	l3	r prog.	Z	Code no.
mm	mm	mm	mm	mm	mm	mm		
3.00	6.00	2.80	80	2.0	30.0	0.5	4	3.000
4.00	6.00	3.80	80	3.0	32.0	0.8	4	4.000
5.00	6.00	4.80	80	4.0	40.0	0.8	4	5.000
6.00	6.00	5.70	80	5.0	43.0	1.0	4	6.000
8.00	8.00	7.70	100	6.0	63.0	1.5	4	8.000
10.00	10.00	9.50	120	8.0	78.0	2.0	4	10.000
12.00	12.00	11.50	120	10.0	73.0	2.0	4	12.000
16.00	16.00	15.50	150	12.0	100.0	2.5	4	16.000

ISO	Hardness	vc	fz (mm/z) / Ø							ap max								
			3	4	5	8	8	10	12	16	3	4	5	8	8	10	12	16
P	≤ 850 N/mm ²	125	0,09	0,13	0,16	0,22	0,29	0,36	0,43	0,58	0,09	0,12	0,15	0,18	0,24	0,30	0,36	0,48
	≥ 850 N/mm ²	85	0,07	0,09	0,11	0,16	0,22	0,27	0,32	0,43	0,08	0,10	0,13	0,15	0,20	0,25	0,30	0,40
K	≤ 240 HB	110	0,08	0,11	0,14	0,19	0,25	0,32	0,38	0,50	0,09	0,12	0,15	0,18	0,24	0,30	0,36	0,48
	≥ 240 HB	90	0,07	0,10	0,12	0,17	0,23	0,29	0,35	0,46	0,08	0,10	0,13	0,15	0,20	0,25	0,30	0,40
H	≤ 55 HRC	60	0,05	0,07	0,09	0,14	0,18	0,23	0,27	0,36	0,06	0,08	0,10	0,12	0,16	0,20	0,24	0,32
	55 - 63 HRC	45	0,03	0,04	0,05	0,08	0,11	0,14	0,16	0,22	0,05	0,06	0,08	0,09	0,12	0,15	0,18	0,24
M	≤ 850 N/mm ²	65	0,08	0,11	0,14	0,19	0,25	0,32	0,38	0,50	0,06	0,08	0,10	0,12	0,16	0,20	0,24	0,32
	≥ 850 N/mm ²	35	0,05	0,07	0,09	0,14	0,18	0,23	0,27	0,36	0,05	0,06	0,08	0,09	0,12	0,15	0,18	0,24
S	Ti	30	0,05	0,07	0,09	0,14	0,18	0,23	0,27	0,36	0,05	0,06	0,08	0,09	0,12	0,15	0,18	0,24

Solid carbide HSC radius milling cutters

Hard profile cutters with Torus grind GF 300 T

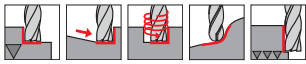
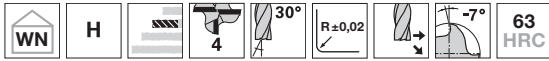

P ○
M □
K ●
N □
S □
H ●

- neck clearance
- centre cutting

GUHRING NAVIGATOR
 Cutting data page 333

Tool material	Solid carbide
Surface	Y
Type	H
Shank form	HA

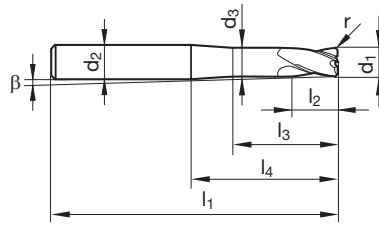

Article no. **3361**

d1 e8	d2 h6	d3	l1	l2	l3	l4	r	β	Z	Code no.
mm	mm	mm	mm	mm	mm	mm	mm	°		
1.00	4.00	0.95	50	2.0	6.0	20.0	0.20	4.00	2	1.002
2.00	6.00	1.90	57	3.0	8.0	21.0	0.20	5.50	2	2.002
2.00	6.00	1.90	57	3.0	8.0	21.0	0.50	5.60	2	2.005
3.00	6.00	2.80	57	5.0	14.0	21.0	0.50	4.20	4	3.000
3.00	6.00	2.80	57	5.0	14.0	21.0	0.30	4.20	4	3.003
4.00	6.00	3.80	57	6.0	16.0	21.0	0.50	2.80	4	4.000
4.00	6.00	3.80	57	6.0	16.0	21.0	0.30	2.80	4	4.003
5.00	6.00	4.80	57	8.0	18.0	21.0	0.50	1.40	4	5.000
5.00	6.00	4.80	57	8.0	18.0	21.0	0.30	1.40	4	5.003
6.00	6.00	5.70	57	9.0	20.0	21.0	1.00		4	6.000
6.00	6.00	5.70	57	9.0	20.0	21.0	0.30		4	6.003
6.00	6.00	5.70	57	9.0	20.0	21.0	0.50		4	6.005
6.00	6.00	5.70	57	9.0	20.0	21.0	1.50		4	6.015
8.00	8.00	7.70	63	12.0	26.0	27.0	1.00		4	8.000
8.00	8.00	7.70	63	12.0	26.0	27.0	0.50		4	8.005
8.00	8.00	7.70	63	12.0	26.0	27.0	2.00		4	8.020
10.00	10.00	9.50	72	15.0	30.0	32.0	1.50		4	10.000
10.00	10.00	9.50	72	15.0	30.0	32.0	0.50		4	10.005
10.00	10.00	9.50	72	15.0	30.0	32.0	1.00		4	10.010
12.00	12.00	11.50	83	18.0	36.0	38.0	1.50		4	12.000
12.00	12.00	11.50	83	18.0	36.0	38.0	0.50		4	12.005
12.00	12.00	11.50	83	18.0	36.0	38.0	1.00		4	12.010
12.00	12.00	11.50	83	18.0	36.0	38.0	2.00		4	12.020
16.00	16.00	15.50	92	24.0	42.0	44.0	2.00		4	16.000
16.00	16.00	15.50	92	24.0	42.0	44.0	3.00		4	16.030

Solid carbide HSC radius milling cutters

ISO	Hardness	vc	fz (mm/z) / Ø							vc	fz (mm/z) / Ø						
			2	3	4	6	8	10	12		2	3	4	6	8	10	12
P	≤ 850 N/mm ²	200	0,024	0,036	0,048	0,072	0,096	0,120	0,144	300	0,017	0,025	0,034	0,050	0,067	0,084	0,101
	≥ 850 N/mm ²	120	0,024	0,036	0,048	0,072	0,096	0,120	0,144	200	0,017	0,025	0,034	0,050	0,067	0,084	0,101
H	≤ 55 HRC	90	0,020	0,030	0,040	0,060	0,080	0,100	0,120	160	0,013	0,020	0,026	0,039	0,052	0,065	0,078
	55 - 63 HRC	180	0,026	0,039	0,052	0,078	0,104	0,130	0,156	270	0,018	0,027	0,036	0,055	0,073	0,091	0,109
K	≥ 240 HB	220	0,030	0,045	0,060	0,090	0,120	0,150	0,180	360	0,018	0,027	0,036	0,054	0,072	0,090	0,108



Hard profile cutters with Torus grind GF 300 T

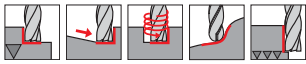
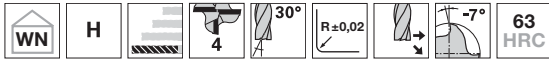

P ○ **GUHRING NAVIGATOR**
 Cutting data page 333

M □
K ●
N □
S □
H ●

- neck clearance
- centre cutting

Tool material	Solid carbide
Surface	Y
Type	H
Shank form	HA

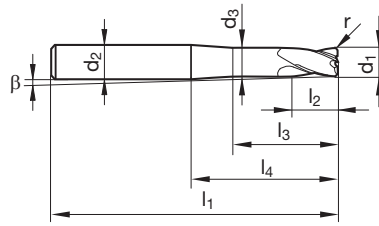

Article no. **3362**

d1 e8	d2 h6	d3	l1	l2	l3	l4	r	β	Z	Code no.
mm	mm	mm	mm	mm	mm	mm	mm	°		
1.00	4.00	0.95	50	2.0	12.0	20.0	0.20	4.40	2	1.002
2.00	6.00	1.90	75	3.0	18.0	35.0	0.50	3.40	2	2.005
3.00	6.00	2.80	75	5.0	25.0	39.0	0.30	2.30	4	3.003
3.00	6.00	2.80	75	5.0	25.0	39.0	0.50	2.30	4	3.005
4.00	6.00	3.80	75	6.0	32.0	39.0	0.30	1.50	4	4.003
4.00	6.00	3.80	75	6.0	32.0	39.0	0.50	1.50	4	4.005
5.00	6.00	4.80	75	8.0	38.0	39.0	0.50	0.80	4	5.005
6.00	6.00	5.70	75	9.0	38.0	39.0	1.00		4	6.000
6.00	6.00	5.70	75	9.0	38.0	39.0	0.50		4	6.005
8.00	8.00	7.70	100	12.0	59.0	60.0	1.00		4	8.000
8.00	8.00	7.70	100	12.0	59.0	60.0	0.50		4	8.005
10.00	10.00	9.50	100	15.0	58.0	60.0	1.50		4	10.000
10.00	10.00	9.50	100	15.0	58.0	60.0	0.50		4	10.005
10.00	10.00	9.50	100	15.0	58.0	60.0	1.00		4	10.010
10.00	10.00	9.50	100	15.0	58.0	60.0	2.00		4	10.020
12.00	12.00	11.50	150	18.0	98.0	100.0	1.50		4	12.000
12.00	12.00	11.50	150	18.0	98.0	100.0	0.50		4	12.005
12.00	12.00	11.50	150	18.0	98.0	100.0	1.00		4	12.010
12.00	12.00	11.50	150	18.0	98.0	100.0	2.00		4	12.020
16.00	16.00	15.50	150	24.0	98.0	100.0	2.00		4	16.000

Solid carbide HSC radius milling cutters

ISO	Hardness	vc	fz (mm/z) / Ø							vc	fz (mm/z) / Ø						
			2	3	4	6	8	10	12		2	3	4	6	8	10	12
P	≤ 850 N/mm ²	100	0,012	0,018	0,024	0,036	0,048	0,060	0,072	150	0,008	0,013	0,017	0,025	0,034	0,042	0,050
	≥ 850 N/mm ²	60	0,012	0,018	0,024	0,036	0,048	0,060	0,072	100	0,008	0,013	0,017	0,025	0,034	0,042	0,050
H	≤ 55 HRC	50	0,010	0,015	0,020	0,030	0,040	0,050	0,060	80	0,007	0,010	0,013	0,020	0,026	0,033	0,039
	55 - 63 HRC	90	0,013	0,020	0,026	0,039	0,052	0,065	0,078	135	0,009	0,014	0,018	0,027	0,036	0,046	0,055
K	≥ 240 HB	220	0,030	0,045	0,060	0,090	0,120	0,150	0,180	360	0,018	0,027	0,036	0,054	0,072	0,090	0,108

Hard multi-tooth end mills corner radius GH 100 H

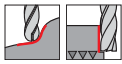
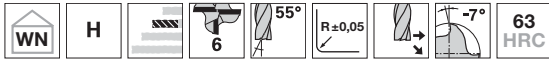

P **GUHRING NAVIGATOR**
 Cutting data page 330

M

K

N

S

H • neck clearance
 • centre cutting

Tool material	Solid carbide
Surface	
Type	H
Shank form	HA

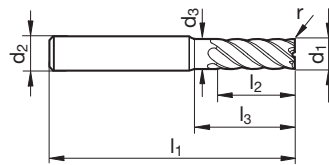

Article no. **4270**

d1 e8	d2 h6	d3	l1	l2	l3	r	Z	Code no.
mm	mm	mm	mm	mm	mm	mm		
3.00	6.00	2.80	57	8.0	11.4	0.3	6	3.003
6.00	6.00	5.70	57	13.0	20.0	1.0	6	6.010
8.00	8.00	7.70	63	19.0	26.0	0.5	6	8.005
8.00	8.00	7.70	63	19.0	26.0	1.0	6	8.010
10.00	10.00	9.50	72	22.0	30.0	0.5	6	10.005
10.00	10.00	9.50	72	22.0	30.0	1.0	6	10.010
10.00	10.00	9.50	72	22.0	30.0	1.5	6	10.015
12.00	12.00	11.50	83	26.0	36.0	0.5	6	12.005
12.00	12.00	11.50	83	26.0	36.0	1.0	6	12.010
12.00	12.00	11.50	83	26.0	36.0	1.5	6	12.015
16.00	16.00	15.50	92	32.0	42.0	1.0	6	16.010
16.00	16.00	15.50	92	32.0	42.0	2.0	6	16.020

Solid carbide HSC radius milling cutters

ISO	Hardness	vc	fz (mm/z) / Ø								vc	fz (mm/z) / Ø							
			3	6	8	10	12	16	20	3		6	8	10	12	16	20		
P	≥ 1000 N/mm ²	180	0,029	0,057	0,076	0,105	0,13	0,17	0,21	180	0,013	0,025	0,033	0,046	0,06	0,07	0,09		
K	≥ 300 HB	180	0,029	0,057	0,076	0,105	0,13	0,17	0,21	180	0,013	0,025	0,033	0,046	0,06	0,07	0,09		
H	≤ 55 HRC	100	0,024	0,048	0,064	0,088	0,11	0,14	0,18	110	0,010	0,019	0,026	0,035	0,04	0,06	0,07		
	≥ 55 HRC	70	0,019	0,038	0,050	0,070	0,08	0,11	0,14	80	0,007	0,014	0,018	0,025	0,03	0,04	0,05		



Hard multi-tooth end mills corner radius GH 100 H

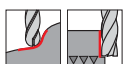

P **GUHRING** NAVIGATOR

M Cutting data page 330

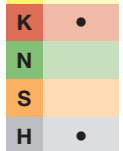

- neck clearance
- centre cutting

Tool material	Solid carbide
Surface	Y
Type	H
Shank form	HA

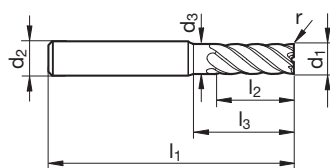

Article no. **3363**

d1 h10	d2 h6	d3	l1	l2	l3	r	Z	Code no.
mm	mm	mm	mm	mm	mm	mm		
6.00	6.00	5.70	75	13.0	38.0	0.5	6	6.000
8.00	8.00	7.70	100	19.0	63.0	0.5	6	8.000
10.00	10.00	9.50	100	22.0	58.0	0.5	6	10.000
12.00	12.00	11.50	150	26.0	103.0	1.0	6	12.000
16.00	16.00	15.50	150	32.0	100.0	1.0	6	16.000

ISO	Hardness	vc	fz (mm/z) / Ø							vc	fz (mm/z) / Ø						
			3	6	8	10	12	16	20		3	6	8	10	12	16	20
P	≥ 1000 N/mm ²	70	0,010	0,020	0,027	0,037	0,044	0,059	0,074	80	0,006	0,013	0,017	0,023	0,028	0,037	0,046
K	≥ 300 HB	70	0,010	0,020	0,027	0,037	0,044	0,059	0,074	80	0,006	0,013	0,017	0,023	0,028	0,037	0,046
H	≤ 55 HRC	40	0,008	0,017	0,022	0,031	0,037	0,049	0,061	50	0,005	0,010	0,013	0,018	0,021	0,028	0,035
	≥ 55 HRC	20	0,007	0,013	0,018	0,025	0,029	0,039	0,049	35	0,003	0,007	0,009	0,013	0,015	0,020	0,025

Solid carbide HSC radius milling cutters

Ball nose slot drills (2-fluted)

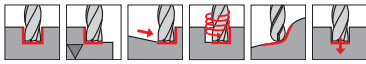
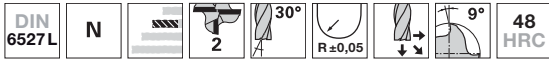

- P** • **GUHRING NAVIGATOR**
- M** • Cutting data page 336
- K** •
- N** •
- S** •
- H** ○ • centre cutting

Tool material	Solid carbide	
Surface	F	F
Type	N	N
Shank form	HA	HB

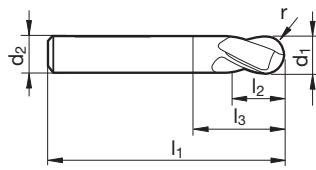

Article no. **3679** **3049**

d1 h10	d2 h6	l1	l2	l3	r	Z	Code no.
mm	mm	mm	mm	mm	mm		
0.50	3.00	38	1.0	2.1	0.2	2	0.500
0.80	3.00	38	1.0	2.1	0.4	2	0.800
1.00	3.00	38	2.0	3.9	0.5	2	1.000
1.50	3.00	38	3.0	6.4	0.7	2	1.500
2.00	6.00	57	6.0	9.4	1.0	2	2.000
3.00	6.00	57	7.0	11.9	1.5	2	3.000
4.00	6.00	57	8.0	13.4	2.0	2	4.000
5.00	6.00	57	10.0	16.9	2.5	2	5.000
6.00	6.00	57	10.0	21.0	3.0	2	6.000
8.00	8.00	63	16.0	27.0	4.0	2	8.000
10.00	10.00	72	19.0	32.0	5.0	2	10.000
12.00	12.00	83	22.0	38.0	6.0	2	12.000
14.00	14.00	83	22.0	38.0	7.0	2	14.000
14.00	16.00	92	26.0	42.0	7.0	2	14.001
16.00	16.00	92	26.0	44.0	8.0	2	16.000
18.00	18.00	92	26.0	44.0	9.0	2	18.000
18.00	20.00	104	32.0	51.0	9.0	2	18.001
20.00	20.00	104	32.0	54.0	10.0	2	20.000

Solid carbide HSC radius milling cutters

ISO	Hardness	vc	fz (mm/z) / Ø								vc	fz (mm/z) / Ø							
			3	6	8	10	12	16	20	3		6	8	10	12	16	20		
P	≤ 850 N/mm ²	175	0,008	0,012	0,016	0,025	0,034	0,042	0,050		280	0,005	0,007	0,010	0,015	0,020	0,025	0,030	
	≥ 850 N/mm ²	140	0,008	0,011	0,015	0,024	0,032	0,040	0,048			220	0,005	0,007	0,010	0,016	0,021	0,026	0,031
M	≤ 750 N/mm ²	120	0,007	0,011	0,014	0,023	0,030	0,038	0,046		190	0,004	0,006	0,009	0,014	0,018	0,023	0,027	
	≥ 750 N/mm ²	55	0,006	0,009	0,012	0,020	0,026	0,033	0,040			100	0,004	0,006	0,007	0,012	0,016	0,020	0,024
S	Ni-based	30	0,005	0,008	0,010	0,017	0,022	0,028	0,034		50	0,003	0,005	0,006	0,010	0,013	0,017	0,020	
	Ti-based	55	0,007	0,011	0,014	0,023	0,030	0,038	0,046			100	0,004	0,006	0,009	0,014	0,018	0,023	0,027
K	≤ 240 HB	140	0,008	0,012	0,016	0,025	0,034	0,042	0,050		230	0,005	0,007	0,010	0,015	0,020	0,025	0,030	
	≥ 240 HB	110	0,008	0,011	0,015	0,024	0,032	0,040	0,048			190	0,005	0,007	0,009	0,014	0,019	0,024	0,029
N	≥ 7 % Si	200	0,010	0,014	0,019	0,030	0,040	0,050	0,060		400	0,006	0,009	0,012	0,018	0,024	0,030	0,036	



Ball nose slot drills (2-fluted)

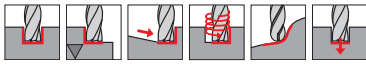

P • **GUHRING NAVIGATOR**
M • Cutting data page 336
K •
N •
S •
H • centre cutting

Tool material	Solid carbide
Surface	○
Type	N
Shank form	HB

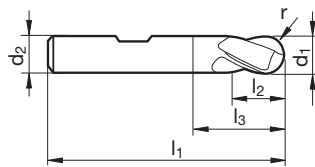

Article no. **3024**

d1 h10	d2 h6	l1	l2	l3	r	Z	Code no.
mm	mm	mm	mm	mm	mm		
3.00	6.00	57	7.0	11.9	1.5	2	3.000
4.00	6.00	57	8.0	13.4	2.0	2	4.000
5.00	6.00	57	10.0	16.9	2.5	2	5.000
6.00	6.00	57	10.0	21.0	3.0	2	6.000
8.00	8.00	63	16.0	27.0	4.0	2	8.000
10.00	10.00	72	19.0	32.0	5.0	2	10.000
12.00	12.00	83	22.0	38.0	6.0	2	12.000
14.00	14.00	83	22.0	38.0	7.0	2	14.000
16.00	16.00	92	26.0	44.0	8.0	2	16.000
18.00	18.00	92	26.0	44.0	9.0	2	18.000
20.00	20.00	104	32.0	54.0	10.0	2	20.000

ISO	Hardness	vc	fz (mm/z) / Ø							vc	fz (mm/z) / Ø							
			3	6	8	10	12	16	20		3	6	8	10	12	16	20	
P	≤ 850 N/mm ²	175	0,008	0,012	0,016	0,025	0,034	0,042	0,050		280	0,005	0,007	0,010	0,015	0,020	0,025	0,030
	≥ 850 N/mm ²	140	0,008	0,011	0,015	0,024	0,032	0,040	0,048		220	0,005	0,007	0,010	0,016	0,021	0,026	0,031
M	≤ 750 N/mm ²	120	0,007	0,011	0,014	0,023	0,030	0,038	0,046		190	0,004	0,006	0,009	0,014	0,018	0,023	0,027
	≥ 750 N/mm ²	55	0,006	0,009	0,012	0,020	0,026	0,033	0,040		100	0,004	0,006	0,007	0,012	0,016	0,020	0,024
S	Ni-based	30	0,005	0,008	0,010	0,017	0,022	0,028	0,034		50	0,003	0,005	0,006	0,010	0,013	0,017	0,020
	Ti-based	55	0,007	0,011	0,014	0,023	0,030	0,038	0,046		100	0,004	0,006	0,009	0,014	0,018	0,023	0,027
K	≤ 240 HB	140	0,008	0,012	0,016	0,025	0,034	0,042	0,050		230	0,005	0,007	0,010	0,015	0,020	0,025	0,030
	≥ 240 HB	110	0,008	0,011	0,015	0,024	0,032	0,040	0,048		190	0,005	0,007	0,009	0,014	0,019	0,024	0,029
N	≥ 7 % Si	200	0,010	0,014	0,019	0,030	0,040	0,050	0,060		400	0,006	0,009	0,012	0,018	0,024	0,030	0,036

Please reduce cutting values for bright finish tools: vc -50% and fz -25%

Solid carbide HSC radius milling cutters

Ball nose slot drills (2-fluted)

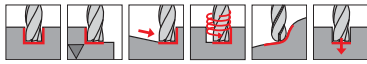

P • **GUHRING NAVIGATOR**
M • Cutting data page 336
K •
N •
S •
H • centre cutting

Tool material	Solid carbide
Surface	○
Type	N
Shank form	HA

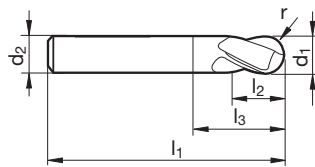

Article no. **3308**

d1 h10	d2 h6	l1	l2	l3	r	Z	Code no.
mm	mm	mm	mm	mm	mm		
0.50	3.00	38	1.0	2.1	0.2	2	0.500
0.80	3.00	38	1.0	2.1	0.4	2	0.800
1.00	3.00	38	2.0	3.9	0.5	2	1.000
1.50	3.00	38	3.0	6.4	0.7	2	1.500
2.00	6.00	57	6.0	9.4	1.0	2	2.000
3.00	6.00	57	7.0	11.9	1.5	2	3.000
4.00	6.00	57	8.0	13.4	2.0	2	4.000
5.00	6.00	57	10.0	16.9	2.5	2	5.000
6.00	6.00	57	10.0	21.0	3.0	2	6.000
8.00	8.00	63	16.0	27.0	4.0	2	8.000
10.00	10.00	72	19.0	32.0	5.0	2	10.000
12.00	12.00	83	22.0	38.0	6.0	2	12.000
14.00	14.00	83	22.0	38.0	7.0	2	14.000
14.00	16.00	92	26.0	42.0	7.0	2	14.001
16.00	16.00	92	26.0	44.0	8.0	2	16.000
18.00	18.00	92	26.0	44.0	9.0	2	18.000
18.00	20.00	104	32.0	51.0	9.0	2	18.001
20.00	20.00	104	32.0	54.0	10.0	2	20.000

Solid carbide HSC radius milling cutters

ISO	Hardness	vc	fz (mm/z) / Ø							vc	fz (mm/z) / Ø							
			3	6	8	10	12	16	20		3	6	8	10	12	16	20	
P	≤ 850 N/mm ²	175	0,008	0,012	0,016	0,025	0,034	0,042	0,050		280	0,005	0,007	0,010	0,015	0,020	0,025	0,030
	≥ 850 N/mm ²	140	0,008	0,011	0,015	0,024	0,032	0,040	0,048		220	0,005	0,007	0,010	0,016	0,021	0,026	0,031
M	≤ 750 N/mm ²	120	0,007	0,011	0,014	0,023	0,030	0,038	0,046		190	0,004	0,006	0,009	0,014	0,018	0,023	0,027
	≥ 750 N/mm ²	55	0,006	0,009	0,012	0,020	0,026	0,033	0,040		100	0,004	0,006	0,007	0,012	0,016	0,020	0,024
S	Ni-based	30	0,005	0,008	0,010	0,017	0,022	0,028	0,034		50	0,003	0,005	0,006	0,010	0,013	0,017	0,020
	Ti-based	55	0,007	0,011	0,014	0,023	0,030	0,038	0,046		100	0,004	0,006	0,009	0,014	0,018	0,023	0,027
K	≤ 240 HB	140	0,008	0,012	0,016	0,025	0,034	0,042	0,050		230	0,005	0,007	0,010	0,015	0,020	0,025	0,030
	≥ 240 HB	110	0,008	0,011	0,015	0,024	0,032	0,040	0,048		190	0,005	0,007	0,009	0,014	0,019	0,024	0,029
N	≥ 7 % Si	200	0,010	0,014	0,019	0,030	0,040	0,050	0,060		400	0,006	0,009	0,012	0,018	0,024	0,030	0,036

Please reduce cutting values for bright finish tools: vc -50% and fz -25%



Ball nose end mills (4-fluted)

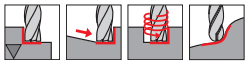

P • **GUHRING NAVIGATOR**
M ○ Cutting data page 336
K •
N ○
S •
H ○ • centre cutting

Tool material	Solid carbide	
Surface	○	●
Type	N	N
Shank form	HA	HA

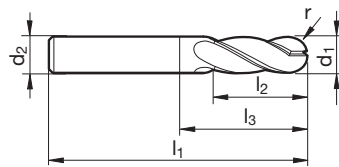

Article no. **3306** **3727**

d1 h10	d2 h6	l1	l2	l3	r	Z	Code no.
mm	mm	mm	mm	mm	mm		
4.00	4.00	50	11.0	22.0	2.0	4	4.000
5.00	5.00	50	13.0	22.0	2.5	4	5.000
6.00	6.00	57	13.0	21.0	3.0	4	6.000
8.00	8.00	63	19.0	27.0	4.0	4	8.000
10.00	10.00	72	22.0	32.0	5.0	4	10.000
12.00	12.00	83	26.0	38.0	6.0	4	12.000
14.00	14.00	83	26.0	38.0	7.0	4	14.000
14.00	16.00	92	32.0	36.0	7.0	4	14.001
16.00	16.00	92	32.0	44.0	8.0	4	16.000
18.00	18.00	92	32.0	44.0	9.0	4	18.000
18.00	20.00	104	38.0	52.0	9.0	4	18.001
20.00	20.00	104	38.0	54.0	10.0	4	20.000

ISO	Hardness	vc	fz (mm/z) / Ø								vc	fz (mm/z) / Ø																			
			3		6		8		10			12		16		20		3		6		8		10		12		16		20	
			ap = 0,1 x D		ap = 0,1 x D		ap = 0,1 x D		ap = 0,1 x D			ap = 0,1 x D		ap = 0,1 x D		ap = 0,1 x D		ap = 0,01 x D		ap = 0,01 x D		ap = 0,01 x D		ap = 0,01 x D		ap = 0,01 x D		ap = 0,01 x D			
P	≤ 850 N/mm ²	175	0,008	0,012	0,016	0,025	0,034	0,042	0,050		280	0,005	0,007	0,010	0,015	0,020	0,025	0,030	220	0,005	0,007	0,010	0,016	0,021	0,026	0,031					
	≥ 850 N/mm ²	140	0,008	0,011	0,015	0,024	0,032	0,040	0,048			0,004	0,006	0,009	0,014	0,018	0,023	0,027		0,004	0,006	0,007	0,012	0,016	0,020	0,024					
M	≤ 750 N/mm ²	120	0,007	0,011	0,014	0,023	0,030	0,038	0,046		190	0,004	0,006	0,009	0,014	0,018	0,023	0,027	100	0,004	0,006	0,007	0,012	0,016	0,020	0,024					
	≥ 750 N/mm ²	55	0,006	0,009	0,012	0,020	0,026	0,033	0,040			0,003	0,005	0,006	0,010	0,013	0,017	0,020		0,004	0,006	0,009	0,014	0,018	0,023	0,027					
S	Ni-based	30	0,005	0,008	0,010	0,017	0,022	0,028	0,034		50	0,003	0,005	0,006	0,010	0,013	0,017	0,020	100	0,004	0,006	0,009	0,014	0,018	0,023	0,027					
	Ti-based	55	0,007	0,011	0,014	0,023	0,030	0,038	0,046			0,005	0,007	0,010	0,015	0,020	0,025	0,030		0,005	0,007	0,009	0,014	0,019	0,024	0,029					
K	≤ 240 HB	140	0,008	0,012	0,016	0,025	0,034	0,042	0,050		230	0,005	0,007	0,010	0,015	0,020	0,025	0,030	190	0,005	0,007	0,009	0,014	0,019	0,024	0,029					
	≥ 240 HB	110	0,008	0,011	0,015	0,024	0,032	0,040	0,048			0,006	0,009	0,012	0,018	0,024	0,030	0,036		0,006	0,009	0,012	0,018	0,024	0,030	0,036					
N	≥ 7 % Si	200	0,010	0,014	0,019	0,030	0,040	0,050	0,060		400	0,006	0,009	0,012	0,018	0,024	0,030	0,036													

Please reduce cutting values for bright finish tools: vc -50% and fz -25%

Solid carbide HSC radius milling cutters

Ball nose end mills (4-fluted)

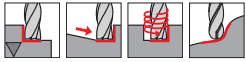

P • **GUHRING NAVIGATOR**
M ○ Cutting data page 336
K •
N ○
S •
H ○ • centre cutting

Tool material	Solid carbide	
Surface	○	●
Type	N	N
Shank form	HB	HB

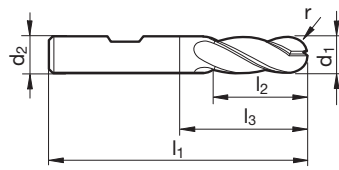

Article no. **3026** **3050**

d1 h10	d2 h6	l1	l2	l3	r	Z	Code no.
mm	mm	mm	mm	mm	mm		
3.00	6.00	57	8.0	12.9	1.5	4	3.000
4.00	6.00	57	11.0	16.9	2.0	4	4.000
5.00	6.00	57	13.0	19.9	2.5	4	5.000
6.00	6.00	57	13.0	21.0	3.0	4	6.000
8.00	8.00	63	19.0	27.0	4.0	4	8.000
10.00	10.00	72	22.0	32.0	5.0	4	10.000
12.00	12.00	83	26.0	38.0	6.0	4	12.000
14.00	14.00	83	26.0	38.0	7.0	4	14.000
16.00	16.00	92	32.0	44.0	8.0	4	16.000
18.00	18.00	92	32.0	44.0	9.0	4	18.000
20.00	20.00	104	38.0	54.0	10.0	4	20.000

Solid carbide HSC radius milling cutters

ISO	Hardness	vc	fz (mm/z) / Ø							vc	fz (mm/z) / Ø							
			3	6	8	10	12	16	20		3	6	8	10	12	16	20	
P	≤ 850 N/mm ²	175	0,008	0,012	0,016	0,025	0,034	0,042	0,050		280	0,005	0,007	0,010	0,015	0,020	0,025	0,030
	≥ 850 N/mm ²	140	0,008	0,011	0,015	0,024	0,032	0,040	0,048		220	0,005	0,007	0,010	0,016	0,021	0,026	0,031
M	≤ 750 N/mm ²	120	0,007	0,011	0,014	0,023	0,030	0,038	0,046		190	0,004	0,006	0,009	0,014	0,018	0,023	0,027
	≥ 750 N/mm ²	55	0,006	0,009	0,012	0,020	0,026	0,033	0,040		100	0,004	0,006	0,007	0,012	0,016	0,020	0,024
S	Ni-based	30	0,005	0,008	0,010	0,017	0,022	0,028	0,034		50	0,003	0,005	0,006	0,010	0,013	0,017	0,020
	Ti-based	55	0,007	0,011	0,014	0,023	0,030	0,038	0,046		100	0,004	0,006	0,009	0,014	0,018	0,023	0,027
K	≤ 240 HB	140	0,008	0,012	0,016	0,025	0,034	0,042	0,050		230	0,005	0,007	0,010	0,015	0,020	0,025	0,030
	≥ 240 HB	110	0,008	0,011	0,015	0,024	0,032	0,040	0,048		190	0,005	0,007	0,009	0,014	0,019	0,024	0,029
N	≥ 7 % Si	200	0,010	0,014	0,019	0,030	0,040	0,050	0,060	400	0,006	0,009	0,012	0,018	0,024	0,030	0,036	

Please reduce cutting values for bright finish tools: vc -50% and fz -25%



XL ball nose slot drills (2-fluted)

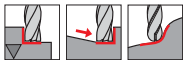

P • **GUHRING NAVIGATOR**
M • Cutting data page 336
K •
N •
S •
H • centre cutting

Tool material	Solid carbide	
Surface	○	⦿
Type	N	N
Shank form	HA	HA

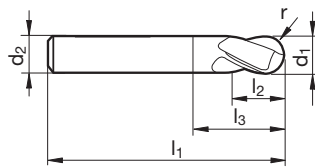

Article no. **3014** **3030**

d1 h10	d2 h6	l1	l2	l3	r	Z	Code no.
mm	mm	mm	mm	mm	mm		
3.00	3.00	75	20.0	47.0	1.5	2	3.000
4.00	4.00	75	25.0	47.0	2.0	2	4.000
5.00	5.00	75	30.0	47.0	2.5	2	5.000
6.00	6.00	75	30.0	39.0	3.0	2	6.000
8.00	8.00	100	40.0	64.0	4.0	2	8.000
10.00	10.00	100	40.0	60.0	5.0	2	10.000
12.00	12.00	150	45.0	105.0	6.0	2	12.000

ISO	Hardness	vc	fz (mm/z) / Ø								vc	fz (mm/z) / Ø							
			3	6	8	10	12	16	20	3		6	8	10	12	16	20		
			ap = 0,1 x D						ae = 0,1 x D			ap = 0,01 x D						ae max = 0,01 x D	
P	≤ 850 N/mm ²	90	0,004	0,006	0,008	0,013	0,017	0,021	0,025	140	0,002	0,004	0,005	0,008	0,010	0,013	0,015		
	≥ 850 N/mm ²	70	0,004	0,006	0,008	0,012	0,016	0,020	0,024	110	0,002	0,004	0,005	0,008	0,010	0,013	0,016		
M	≤ 750 N/mm ²	60	0,004	0,005	0,007	0,009	0,011	0,015	0,019	100	0,002	0,003	0,004	0,007	0,009	0,011	0,014		
	≥ 750 N/mm ²	30	0,003	0,005	0,006	0,010	0,013	0,017	0,020	50	0,002	0,003	0,004	0,006	0,008	0,010	0,012		
S	Ni-based	20	0,003	0,004	0,005	0,008	0,011	0,014	0,017	30	0,002	0,002	0,003	0,005	0,007	0,008	0,010		
	Ti-based	30	0,004	0,005	0,007	0,011	0,015	0,019	0,023	50	0,002	0,003	0,004	0,007	0,009	0,011	0,014		
K	≤ 240 HB	70	0,004	0,006	0,008	0,013	0,017	0,021	0,025	120	0,002	0,004	0,005	0,008	0,010	0,013	0,015		
	≥ 240 HB	55	0,004	0,006	0,008	0,012	0,016	0,020	0,024	100	0,002	0,003	0,005	0,007	0,010	0,012	0,014		
N	≥ 7 % Si	100	0,005	0,007	0,010	0,015	0,020	0,025	0,030	200	0,003	0,004	0,006	0,009	0,012	0,015	0,018		

Please reduce cutting values for bright finish tools: vc -50% and fz -25%

Solid carbide HSC radius milling cutters

XL ball nose end mills (4-fluted)

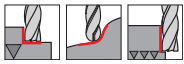

- P** • **GUHRING NAVIGATOR**
- M** • Cutting data page 336
- K** ○
- N** ○
- S** •
- H** • centre cutting

Tool material	Solid carbide	
Surface	○	●
Type	N	N
Shank form	HA	HA

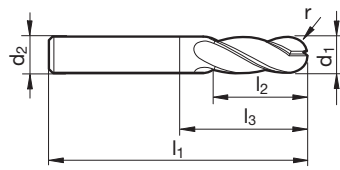

Article no. **3015** **3043**

d1 h10	d2 h6	l1	l2	l3	r	Z	Code no.
mm	mm	mm	mm	mm	mm		
3.00	3.00	75	20.0	47.0	1.5	4	3.000
4.00	4.00	75	25.0	47.0	2.0	4	4.000
5.00	5.00	75	30.0	47.0	2.5	4	5.000
6.00	6.00	75	30.0	39.0	3.0	4	6.000
8.00	8.00	100	40.0	64.0	4.0	4	8.000
10.00	10.00	100	40.0	60.0	5.0	4	10.000
12.00	12.00	150	45.0	105.0	6.0	4	12.000

Solid carbide HSC radius milling cutters

ISO	Hardness	vc	fz (mm/z) / Ø								vc	fz (mm/z) / Ø							
			3	6	8	10	12	16	20	3		6	8	10	12	16	20		
P	≤ 850 N/mm ²	90	0,004	0,006	0,008	0,013	0,017	0,021	0,025		140	0,002	0,004	0,005	0,008	0,010	0,013	0,015	
	≥ 850 N/mm ²	70	0,004	0,006	0,008	0,012	0,016	0,020	0,024		110	0,002	0,004	0,005	0,008	0,010	0,013	0,016	
M	≤ 750 N/mm ²	60	0,004	0,005	0,007	0,009	0,011	0,015	0,019		100	0,002	0,003	0,004	0,007	0,009	0,011	0,014	
	≥ 750 N/mm ²	30	0,003	0,005	0,006	0,010	0,013	0,017	0,020		50	0,002	0,003	0,004	0,006	0,008	0,010	0,012	
S	Ni-based	20	0,003	0,004	0,005	0,008	0,011	0,014	0,017		30	0,002	0,002	0,003	0,005	0,007	0,008	0,010	
	Ti-based	30	0,004	0,005	0,007	0,011	0,015	0,019	0,023		50	0,002	0,003	0,004	0,007	0,009	0,011	0,014	
K	≤ 240 HB	70	0,004	0,006	0,008	0,013	0,017	0,021	0,025		120	0,002	0,004	0,005	0,008	0,010	0,013	0,015	
	≥ 240 HB	55	0,004	0,006	0,008	0,012	0,016	0,020	0,024		100	0,002	0,003	0,005	0,007	0,010	0,012	0,014	
N	≥ 7 % Si	100	0,005	0,007	0,010	0,015	0,020	0,025	0,030		200	0,003	0,004	0,006	0,009	0,012	0,015	0,018	

Please reduce cutting values for bright finish tools: vc -50% and fz -25%



HSC-ball nose end mills GF 500 B

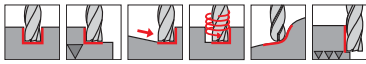
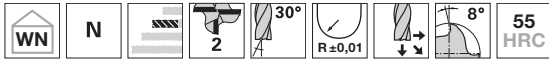

- P** • **GUHRING NAVIGATOR**
 - M** • Cutting data page 332
 - K** •
 - N** ○
 - S** •
 - H** •
- centre cutting

Tool material	Solid carbide
Surface	Y
Type	N
Shank form	HA

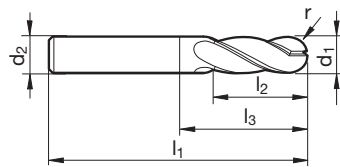

Article no. **3854**

d1 h10	d2 h6	l1	l2	l3	r	Z	Code no.
mm	mm	mm	mm	mm	mm		
6.00	6.00	57	12.0	24.0	3.0	2	6.000
8.00	8.00	63	16.0	29.0	4.0	2	8.000
10.00	10.00	72	20.0	35.0	5.0	2	10.000
12.00	12.00	83	24.0	42.0	6.0	2	12.000

ISO	Hardness	vc	fz (mm/z) / Ø							vc	fz (mm/z) / Ø						
			2	3	4	6	8	10	12		2	3	4	6	8	10	12
P	≤ 850 N/mm ²	240	0,030	0,045	0,060	0,090	0,120	0,150	0,180	390	0,018	0,027	0,036	0,054	0,072	0,090	0,108
	≥ 850 N/mm ²	200	0,024	0,036	0,048	0,072	0,096	0,120	0,144		320	0,016	0,023	0,031	0,047	0,062	0,078
H	≤ 55 HRC	130	0,024	0,036	0,048	0,072	0,096	0,120	0,144	220	0,014	0,022	0,029	0,043	0,058	0,072	0,086
M	≤ 750 N/mm ²	160	0,026	0,039	0,052	0,078	0,104	0,130	0,156	260	0,016	0,023	0,031	0,047	0,062	0,078	0,094
	≥ 750 N/mm ²	80	0,020	0,030	0,040	0,060	0,080	0,100	0,120		140	0,012	0,018	0,024	0,036	0,048	0,060
S	Ni-based	45	0,020	0,030	0,040	0,060	0,080	0,100	0,120	80	0,012	0,018	0,024	0,036	0,048	0,060	0,072
	Ti-based	100	0,024	0,036	0,048	0,072	0,096	0,120	0,144		170	0,014	0,022	0,029	0,043	0,058	0,072
K	≤ 240 HB	220	0,030	0,045	0,060	0,090	0,120	0,150	0,180	360	0,018	0,027	0,036	0,054	0,072	0,090	0,108
	≥ 240 HB	180	0,026	0,039	0,052	0,078	0,104	0,130	0,156		300	0,016	0,023	0,031	0,047	0,062	0,078
N	≥ 7 % Si	300	0,030	0,045	0,060	0,090	0,120	0,150	0,180	500	0,018	0,027	0,036	0,054	0,072	0,090	0,108

Solid carbide HSC radius milling cutters

HSC-ball nose end mills GF 500 B

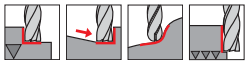
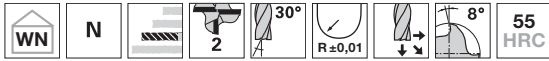

P • **GUHRING NAVIGATOR**
M • Cutting data page 332
K •
N ○
S •
H • • centre cutting

Tool material	Solid carbide
Surface	Ⓚ
Type	N
Shank form	HA

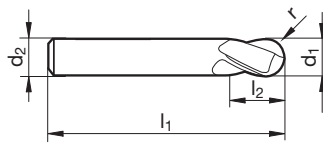

Article no. **3866**

d1 h10	d2 h6	l1	l2	l3	r	Z	Code no.
mm	mm	mm	mm	mm	mm		
4.00	4.00	80	8.0	18.0	2.0	2	4.000
6.00	6.00	100	12.0	24.0	3.0	2	6.000
8.00	8.00	100	16.0	29.0	4.0	2	8.000
10.00	10.00	100	20.0	35.0	5.0	2	10.000
12.00	12.00	120	24.0	42.0	6.0	2	12.000

Solid carbide HSC radius milling cutters

ISO	Hardness	vc	fz (mm/z) / Ø							vc	fz (mm/z) / Ø						
			2	3	4	6	8	10	12		2	3	4	6	8	10	12
P	≤ 850 N/mm ²	180	0,023	0,034	0,045	0,068	0,090	0,113	0,135	300	0,014	0,020	0,027	0,041	0,054	0,068	0,081
	≥ 850 N/mm ²	150	0,018	0,027	0,036	0,054	0,072	0,090	0,108	240	0,012	0,018	0,023	0,035	0,047	0,059	0,070
H	≤ 55 HRC	100	0,018	0,027	0,036	0,054	0,072	0,090	0,108	170	0,011	0,016	0,022	0,032	0,043	0,054	0,065
M	≤ 750 N/mm ²	120	0,020	0,029	0,039	0,049	0,059	0,078	0,098	200	0,012	0,018	0,023	0,035	0,047	0,059	0,070
	≥ 750 N/mm ²	60	0,015	0,023	0,030	0,045	0,060	0,075	0,090	110	0,009	0,014	0,018	0,027	0,036	0,045	0,054
S	Ni-based	40	0,015	0,023	0,030	0,045	0,060	0,075	0,090	60	0,009	0,014	0,018	0,027	0,036	0,045	0,054
	Ti-based	75	0,018	0,027	0,036	0,054	0,072	0,090	0,108	130	0,011	0,016	0,022	0,032	0,043	0,054	0,065
K	≤ 240 HB	165	0,023	0,034	0,045	0,068	0,090	0,113	0,135	270	0,014	0,020	0,027	0,041	0,054	0,068	0,081
	≥ 240 HB	135	0,020	0,029	0,039	0,059	0,078	0,098	0,117	230	0,012	0,018	0,023	0,035	0,047	0,059	0,070
N	≥ 7 % Si	225	0,023	0,034	0,045	0,068	0,090	0,113	0,135	380	0,014	0,020	0,027	0,041	0,054	0,068	0,081



HSC-ball nose end mills GF 500 B

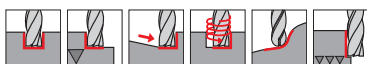
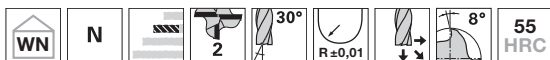

P • **GUHRING NAVIGATOR**
M • Cutting data page 332
K •
N ○
S •
H •

- neck clearance
- centre cutting

Tool material	Solid carbide
Surface	Y
Type	N
Shank form	HA

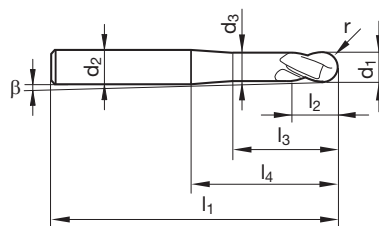

Article no. **3848**

d1 h10	d2 h6	d3	l1	l2	l3	l4	r	β	Z	Code no.
mm	mm	mm	mm	mm	mm	mm	mm	°		
2.00	6.00	1.80	57	3.0	8.0	20.0	1.00	6.10	2	2.000
3.00	6.00	2.80	57	3.5	9.0	20.0	1.50	4.70	2	3.000
4.00	6.00	3.80	57	4.0	9.4	20.0	2.00	3.20	2	4.000
6.00	6.00	5.60	57	6.0	19.0	21.0	3.00		2	6.000
8.00	8.00	7.60	63	7.0	25.0	27.0	4.00		2	8.000
10.00	10.00	9.60	72	8.0	28.0	32.0	5.00		2	10.000
12.00	12.00	11.50	83	10.0	33.0	38.0	6.00		2	12.000

ISO	Hardness	vc	fz (mm/z) / Ø								vc	fz (mm/z) / Ø							
			2	3	4	6	8	10	12	2		3	4	6	8	10	12		
P	≤ 850 N/mm ²	240	0,030	0,045	0,060	0,090	0,120	0,150	0,180		390	0,018	0,027	0,036	0,054	0,072	0,090	0,108	
	≥ 850 N/mm ²	200	0,024	0,036	0,048	0,072	0,096	0,120	0,144		320	0,016	0,023	0,031	0,047	0,062	0,078	0,094	
H	≤ 55 HRC	130	0,024	0,036	0,048	0,072	0,096	0,120	0,144		220	0,014	0,022	0,029	0,043	0,058	0,072	0,086	
		160	0,026	0,039	0,052	0,078	0,104	0,130	0,156		260	0,016	0,023	0,031	0,047	0,062	0,078	0,094	
M	≤ 750 N/mm ²	80	0,020	0,030	0,040	0,060	0,080	0,100	0,120		140	0,012	0,018	0,024	0,036	0,048	0,060	0,072	
	≥ 750 N/mm ²	100	0,024	0,036	0,048	0,072	0,096	0,120	0,144		170	0,014	0,022	0,029	0,043	0,058	0,072	0,086	
S	Ni-based	45	0,020	0,030	0,040	0,060	0,080	0,100	0,120		80	0,012	0,018	0,024	0,036	0,048	0,060	0,072	
	Ti-based	100	0,024	0,036	0,048	0,072	0,096	0,120	0,144		170	0,014	0,022	0,029	0,043	0,058	0,072	0,086	
K	≤ 240 HB	220	0,030	0,045	0,060	0,090	0,120	0,150	0,180		360	0,018	0,027	0,036	0,054	0,072	0,090	0,108	
	≥ 240 HB	180	0,026	0,039	0,052	0,078	0,104	0,130	0,156		300	0,016	0,023	0,031	0,047	0,062	0,078	0,094	
N	≥ 7 % Si	300	0,030	0,045	0,060	0,090	0,120	0,150	0,180		500	0,018	0,027	0,036	0,054	0,072	0,090	0,108	

Solid carbide HSC radius milling cutters

HSC-ball nose end mills GF 500 B

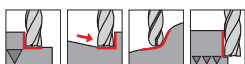

P • **GUHRING NAVIGATOR**
M • Cutting data page 332
K •
N ○
S •
H •

- neck clearance
- centre cutting

Tool material	Solid carbide
Surface	Y
Type	N
Shank form	cyl.

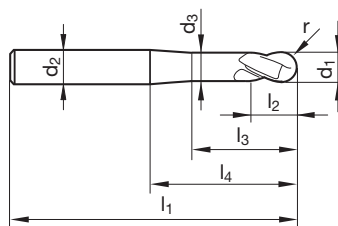

Article no. **3855**

d1 h10	d2 h6	d3	l1	l2	l3	l4	r	Z	Code no.
mm	mm	mm	mm	mm	mm	mm	mm		
6.00	6.00	5.60	80	6.0	39.0	44.0	3.00	2	6.000
8.00	8.00	7.60	100	7.0	59.0	64.0	4.00	2	8.000
10.00	10.00	9.60	120	8.0	73.0	80.0	5.00	2	10.000
12.00	12.00	11.50	120	10.0	68.0	75.0	6.00	2	12.000

Solid carbide HSC radius milling cutters

ISO	Hardness	vc	fz (mm/z) / Ø							vc	fz (mm/z) / Ø						
			2	3	4	6	8	10	12		2	3	4	6	8	10	12
P	≤ 850 N/mm ²	120	0,015	0,023	0,030	0,045	0,060	0,075	0,090	200	0,009	0,014	0,018	0,027	0,036	0,045	0,054
	≥ 850 N/mm ²	100	0,012	0,018	0,024	0,036	0,048	0,060	0,072	160	0,008	0,012	0,016	0,023	0,031	0,039	0,047
H	≤ 55 HRC	70	0,012	0,018	0,024	0,036	0,048	0,060	0,072	110	0,007	0,011	0,014	0,022	0,029	0,036	0,043
	≥ 750 N/mm ²	80	0,013	0,020	0,026	0,033	0,039	0,052	0,065	130	0,008	0,012	0,016	0,023	0,031	0,039	0,047
M	≤ 750 N/mm ²	40	0,010	0,015	0,020	0,030	0,040	0,050	0,060	70	0,006	0,009	0,012	0,018	0,024	0,030	0,036
	≥ 750 N/mm ²	30	0,010	0,015	0,020	0,030	0,040	0,050	0,060	40	0,006	0,009	0,012	0,018	0,024	0,030	0,036
S	Ni-based	50	0,012	0,018	0,024	0,036	0,048	0,060	0,072	90	0,007	0,011	0,014	0,022	0,029	0,036	0,043
	Ti-based	110	0,015	0,023	0,030	0,045	0,060	0,075	0,090	180	0,009	0,014	0,018	0,027	0,036	0,045	0,054
K	≤ 240 HB	90	0,013	0,020	0,026	0,039	0,052	0,065	0,078	150	0,008	0,012	0,016	0,023	0,031	0,039	0,047
	≥ 240 HB	150	0,015	0,023	0,030	0,045	0,060	0,075	0,090	250	0,009	0,014	0,018	0,027	0,036	0,045	0,054
N	≥ 7 % Si	150	0,015	0,023	0,030	0,045	0,060	0,075	0,090	250	0,009	0,014	0,018	0,027	0,036	0,045	0,054



HSC-ball nose end mills GF 500 B

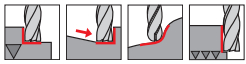
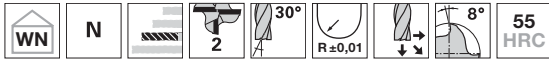

P • **GUHRING NAVIGATOR**
M • Cutting data page 332
K •
N ○
S •
H •

- neck clearance
- centre cutting

Tool material	Solid carbide
Surface	Y
Type	N
Shank form	HA

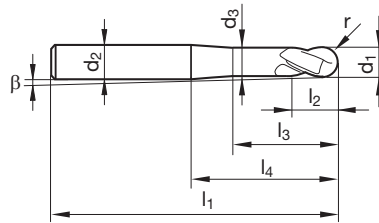

Article no. **3849**

d1 h10	d2 h6	d3	l1	l2	l3	l4	r	β	Z	Code no.
mm	mm	mm	mm	mm	mm	mm	mm	°		
2.00	6.00	1.80	80	3.0	8.0	40.0	1.00	3.00	2	2.000
3.00	6.00	2.80	80	3.5	12.0	40.0	1.50	2.30	2	3.000
4.00	6.00	3.80	80	4.0	20.0	40.0	2.00	1.60	2	4.000
5.00	6.00	4.70	80	5.0	25.0	40.0	2.50	0.80	2	5.000
6.00	8.00	5.60	100	6.0	25.0	60.0	3.00	1.10	2	6.000
8.00	10.00	7.60	120	7.0	30.0	75.0	4.00	0.90	2	8.000
10.00	12.00	9.60	120	8.0	30.0	70.0	5.00	0.90	2	10.000
12.00	16.00	11.50	150	10.0	35.0	100.0	6.00	1.30	2	12.000

ISO	Hardness	vc	fz (mm/z) / Ø							vc	fz (mm/z) / Ø						
			2	3	4	6	8	10	12		2	3	4	6	8	10	12
P	≤ 850 N/mm ²	120	0,015	0,023	0,030	0,045	0,060	0,075	0,090	200	0,009	0,014	0,018	0,027	0,036	0,045	0,054
	≥ 850 N/mm ²	100	0,012	0,018	0,024	0,036	0,048	0,060	0,072		160	0,008	0,012	0,016	0,023	0,031	0,039
H	≤ 55 HRC	70	0,012	0,018	0,024	0,036	0,048	0,060	0,072	110	0,007	0,011	0,014	0,022	0,029	0,036	0,043
M	≤ 750 N/mm ²	80	0,013	0,020	0,026	0,033	0,039	0,052	0,065	130	0,008	0,012	0,016	0,023	0,031	0,039	0,047
	≥ 750 N/mm ²	40	0,010	0,015	0,020	0,030	0,040	0,050	0,060		70	0,006	0,009	0,012	0,018	0,024	0,030
S	Ni-based	30	0,010	0,015	0,020	0,030	0,040	0,050	0,060	40	0,006	0,009	0,012	0,018	0,024	0,030	0,036
	Ti-based	50	0,012	0,018	0,024	0,036	0,048	0,060	0,072		90	0,007	0,011	0,014	0,022	0,029	0,036
K	≤ 240 HB	110	0,015	0,023	0,030	0,045	0,060	0,075	0,090	180	0,009	0,014	0,018	0,027	0,036	0,045	0,054
	≥ 240 HB	90	0,013	0,020	0,026	0,039	0,052	0,065	0,078		150	0,008	0,012	0,016	0,023	0,031	0,039
N	≥ 7 % Si	150	0,015	0,023	0,030	0,045	0,060	0,075	0,090	250	0,009	0,014	0,018	0,027	0,036	0,045	0,054

Solid carbide HSC radius milling cutters

HSC-ball nose end mills GF 500 B

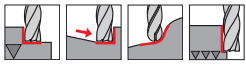
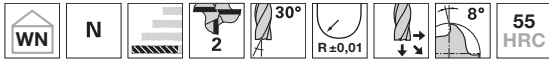

P • **GUHRING NAVIGATOR**
M • Cutting data page 332
K •
N ○
S •
H •

- neck clearance
- centre cutting

Tool material	Solid carbide
Surface	Y
Type	N
Shank form	HA

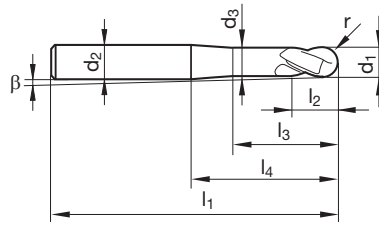

Article no. **3853**

d1 h10	d2 h6	d3	l1	l2	l3	l4	r	β	Z	Code no.
mm	mm	mm	mm	mm	mm	mm	mm	°		
2.00	6.00	1.80	80	3.0	8.0	40.0	1.00	1.00	2	2.000
3.00	6.00	2.80	80	3.5	12.0	45.0	1.50	1.00	2	3.000
4.00	6.00	3.80	100	4.0	20.0	60.0	2.00	1.00	2	4.000
6.00	8.00	5.60	120	6.0	25.0	80.0	3.00	0.80	2	6.000
8.00	10.00	7.60	150	7.0	20.0	105.0	4.00	0.60	2	8.000

Solid carbide HSC radius milling cutters

ISO	Hardness	vc	fz (mm/z) / Ø							vc	fz (mm/z) / Ø						
			2	3	4	6	8	10	12		2	3	4	6	8	10	12
P	≤ 850 N/mm ²	120	0,015	0,023	0,030	0,045	0,060	0,075	0,090	200	0,009	0,014	0,018	0,027	0,036	0,045	0,054
	≥ 850 N/mm ²	100	0,012	0,018	0,024	0,036	0,048	0,060	0,072		160	0,008	0,012	0,016	0,023	0,031	0,039
H	≤ 55 HRC	70	0,012	0,018	0,024	0,036	0,048	0,060	0,072	110	0,007	0,011	0,014	0,022	0,029	0,036	0,043
M	≤ 750 N/mm ²	80	0,013	0,020	0,026	0,033	0,039	0,052	0,065	130	0,008	0,012	0,016	0,023	0,031	0,039	0,047
	≥ 750 N/mm ²	40	0,010	0,015	0,020	0,030	0,040	0,050	0,060		70	0,006	0,009	0,012	0,018	0,024	0,030
S	Ni-based	30	0,010	0,015	0,020	0,030	0,040	0,050	0,060	40	0,006	0,009	0,012	0,018	0,024	0,030	0,036
	Ti-based	50	0,012	0,018	0,024	0,036	0,048	0,060	0,072		90	0,007	0,011	0,014	0,022	0,029	0,036
K	≤ 240 HB	110	0,015	0,023	0,030	0,045	0,060	0,075	0,090	180	0,009	0,014	0,018	0,027	0,036	0,045	0,054
	≥ 240 HB	90	0,013	0,020	0,026	0,039	0,052	0,065	0,078		150	0,008	0,012	0,016	0,023	0,031	0,039
N	≥ 7 % Si	150	0,015	0,023	0,030	0,045	0,060	0,075	0,090	250	0,009	0,014	0,018	0,027	0,036	0,045	0,054



HSC-ball nose end mills GF 500 B

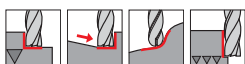

P • **GUHRING NAVIGATOR**
M • Cutting data page 332
K •
N ○
S •
H •

- neck clearance
- centre cutting

Tool material	Solid carbide
Surface	Y
Type	N
Shank form	HA

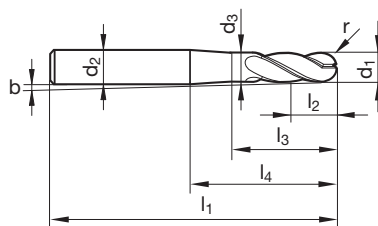

Article no. **4248**

d1 h10	d2 h6	d3	l1	l2	l3	l4	r	β	Z	Code no.
mm	mm	mm	mm	mm	mm	mm	mm	°		
2.00	6.00	1.90	57	3.0	10.0	21.0	1.00	5.80	4	2.000
3.00	6.00	2.80	57	3.5	14.0	21.0	1.50	4.40	4	3.000
4.00	6.00	3.80	57	4.0	16.0	21.0	2.00	3.10	4	4.000
5.00	6.00	4.80	57	5.0	18.0	21.0	2.50	1.60	4	5.000
6.00	6.00	5.70	57	6.0	20.0	21.0	3.00		4	6.000
8.00	8.00	7.70	63	7.0	26.0	27.0	4.00		4	8.000
10.00	10.00	9.50	72	8.0	30.0	32.0	5.00		4	10.000
12.00	12.00	11.50	83	10.0	36.0	38.0	6.00		4	12.000

ISO	Hardness	vc	fz (mm/z) / Ø								vc	fz (mm/z) / Ø							
			ap = 0,1 x D				ap = 0,1 x D					ap = 0,01 x D				ap max = 0,01 x D			
			2	3	4	6	8	10	12		2	3	4	6	8	10	12		
P	≤ 850 N/mm ²	240	0,030	0,045	0,060	0,090	0,120	0,150	0,180	390	0,018	0,027	0,036	0,054	0,072	0,090	0,108		
	≥ 850 N/mm ²	200	0,024	0,036	0,048	0,072	0,096	0,120	0,144		320	0,016	0,023	0,031	0,047	0,062	0,078	0,094	
H	≤ 55 HRC	130	0,024	0,036	0,048	0,072	0,096	0,120	0,144	220	0,014	0,022	0,029	0,043	0,058	0,072	0,086		
M	≤ 750 N/mm ²	160	0,026	0,039	0,052	0,078	0,104	0,130	0,156	260	0,016	0,023	0,031	0,047	0,062	0,078	0,094		
	≥ 750 N/mm ²	80	0,020	0,030	0,040	0,060	0,080	0,100	0,120		140	0,012	0,018	0,024	0,036	0,048	0,060	0,072	
S	Ni-based	45	0,020	0,030	0,040	0,060	0,080	0,100	0,120	80	0,012	0,018	0,024	0,036	0,048	0,060	0,072		
	Ti-based	100	0,024	0,036	0,048	0,072	0,096	0,120	0,144		170	0,014	0,022	0,029	0,043	0,058	0,072	0,086	
K	≤ 240 HB	220	0,030	0,045	0,060	0,090	0,120	0,150	0,180	360	0,018	0,027	0,036	0,054	0,072	0,090	0,108		
	≥ 240 HB	180	0,026	0,039	0,052	0,078	0,104	0,130	0,156		300	0,016	0,023	0,031	0,047	0,062	0,078	0,094	
N	≥ 7 % Si	300	0,030	0,045	0,060	0,090	0,120	0,150	0,180	500	0,018	0,027	0,036	0,054	0,072	0,090	0,108		

Solid carbide HSC radius milling cutters

HSC-ball nose end mills GF 500 B

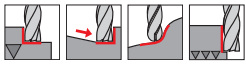
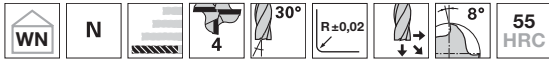

P • **GUHRING NAVIGATOR**
M • Cutting data page 332
K •
N ○
S •
H •

- neck clearance
- centre cutting

Tool material	Solid carbide
Surface	Y
Type	N
Shank form	cyl.

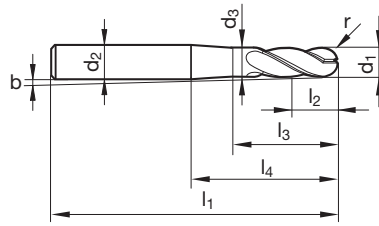

Article no. **4249**

d1 h10	d2 h6	d3	l1	l2	l3	l4	r	β	Z	Code no.
mm	mm	mm	mm	mm	mm	mm	mm	°		
2.00	6.00	1.90	80	3.0	10.0	40.0	1.00	3.00	4	2.000
3.00	6.00	2.80	80	3.5	14.0	40.0	1.50	2.30	4	3.000
4.00	6.00	3.80	80	4.0	16.0	40.0	2.00	1.60	4	4.000
5.00	6.00	4.80	100	5.0	18.0	50.0	2.50	0.70	4	5.000
6.00	6.00	5.70	100	6.0	49.0	50.0	3.00		4	6.000
8.00	8.00	7.70	100	7.0	49.0	50.0	4.00		4	8.000
10.00	10.00	9.50	100	8.0	48.0	50.0	5.00		4	10.000
12.00	12.00	11.50	120	10.0	68.0	70.0	6.00		4	12.000

Solid carbide HSC radius milling cutters

ISO	Hardness	vc	fz (mm/z) / Ø								vc	fz (mm/z) / Ø							
			2	3	4	6	8	10	12	2		3	4	6	8	10	12		
P	≤ 850 N/mm ²	120	0,015	0,023	0,030	0,045	0,060	0,075	0,090		200	0,009	0,014	0,018	0,027	0,036	0,045	0,054	
	≥ 850 N/mm ²	100	0,012	0,018	0,024	0,036	0,048	0,060	0,072		160	0,008	0,012	0,016	0,023	0,031	0,039	0,047	
H	≤ 55 HRC	70	0,012	0,018	0,024	0,036	0,048	0,060	0,072		110	0,007	0,011	0,014	0,022	0,029	0,036	0,043	
M	≤ 750 N/mm ²	80	0,013	0,020	0,026	0,033	0,039	0,052	0,065		130	0,008	0,012	0,016	0,023	0,031	0,039	0,047	
	≥ 750 N/mm ²	40	0,010	0,015	0,020	0,030	0,040	0,050	0,060		70	0,006	0,009	0,012	0,018	0,024	0,030	0,036	
S	Ni-based	30	0,010	0,015	0,020	0,030	0,040	0,050	0,060		40	0,006	0,009	0,012	0,018	0,024	0,030	0,036	
	Ti-based	50	0,012	0,018	0,024	0,036	0,048	0,060	0,072		90	0,007	0,011	0,014	0,022	0,029	0,036	0,043	
K	≤ 240 HB	110	0,015	0,023	0,030	0,045	0,060	0,075	0,090		180	0,009	0,014	0,018	0,027	0,036	0,045	0,054	
	≥ 240 HB	90	0,013	0,020	0,026	0,039	0,052	0,065	0,078		150	0,008	0,012	0,016	0,023	0,031	0,039	0,047	
N	≥ 7 % Si	150	0,015	0,023	0,030	0,045	0,060	0,075	0,090		250	0,009	0,014	0,018	0,027	0,036	0,045	0,054	



Ball nose end mills GF 200 B

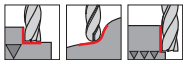
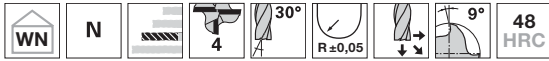

- P** • **GUHRING NAVIGATOR**
 - M** • Cutting data page 332
 - K** •
 - N** ○
 - S** •
 - H** •
- centre cutting

Tool material	Solid carbide
Surface	F
Type	N
Shank form	HA

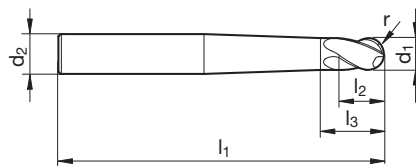

Article no. **3045**

d1 h10	d2 h6	l1	l2	l3	r	Z	Code no.
mm	mm	mm	mm	mm	mm		
3.00	6.00	75	4.0	8.4	1.5	4	3.000
4.00	6.00	75	5.0	9.9	2.0	4	4.000
5.00	6.00	75	6.0	12.4	2.5	4	5.000
6.00	8.00	75	8.0	15.4	3.0	4	6.000
8.00	10.00	100	12.0	19.9	4.0	4	8.000
10.00	12.00	100	15.0	24.4	5.0	4	10.000

ISO	Hardness	vc	fz (mm/z) / Ø							vc	fz (mm/z) / Ø						
			2	3	4	6	8	10	12		2	3	4	6	8	10	12
P	≤ 850 N/mm ²	180	0,023	0,034	0,045	0,068	0,090	0,113	0,135	300	0,014	0,020	0,027	0,041	0,054	0,068	0,081
	≥ 850 N/mm ²	150	0,018	0,027	0,036	0,054	0,072	0,090	0,108	240	0,012	0,018	0,023	0,035	0,047	0,059	0,070
H	≤ 55 HRC	100	0,018	0,027	0,036	0,054	0,072	0,090	0,108	170	0,011	0,016	0,022	0,032	0,043	0,054	0,065
M	≤ 750 N/mm ²	120	0,020	0,029	0,039	0,049	0,059	0,078	0,098	200	0,012	0,018	0,023	0,035	0,047	0,059	0,070
	≥ 750 N/mm ²	60	0,015	0,023	0,030	0,045	0,060	0,075	0,090	110	0,009	0,014	0,018	0,027	0,036	0,045	0,054
S	Ni-based	40	0,015	0,023	0,030	0,045	0,060	0,075	0,090	60	0,009	0,014	0,018	0,027	0,036	0,045	0,054
	Ti-based	75	0,018	0,027	0,036	0,054	0,072	0,090	0,108	130	0,011	0,016	0,022	0,032	0,043	0,054	0,065
K	≤ 240 HB	165	0,023	0,034	0,045	0,068	0,090	0,113	0,135	270	0,014	0,020	0,027	0,041	0,054	0,068	0,081
	≥ 240 HB	135	0,020	0,029	0,039	0,059	0,078	0,098	0,117	230	0,012	0,018	0,023	0,035	0,047	0,059	0,070
N	≥ 7 % Si	225	0,023	0,034	0,045	0,068	0,090	0,113	0,135	380	0,014	0,020	0,027	0,041	0,054	0,068	0,081

Solid carbide HSC radius milling cutters

Ball nose end mills GF 200 B

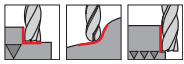
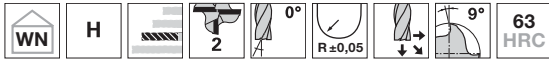

P • **GUHRING NAVIGATOR**
 Cutting data page 332

M

K •

N

S

H • • centre cutting

Tool material	Solid carbide
Surface	F
Type	H
Shank form	HA

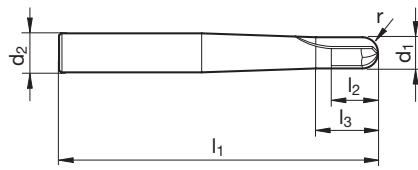

Article no. **3044**

d1 h10	d2 h6	l1	l2	l3	r	Z	Code no.
mm	mm	mm	mm	mm	mm		
3.00	6.00	75	4.0	8.9	1.5	2	3.000
4.00	6.00	75	5.0	10.4	2.0	2	4.000
5.00	6.00	75	6.0	12.9	2.5	2	5.000
6.00	8.00	75	8.0	16.4	3.0	2	6.000
8.00	10.00	100	12.0	21.4	4.0	2	8.000
10.00	12.00	100	15.0	26.4	5.0	2	10.000

ISO	Hardness	vc	fz (mm/z) / Ø							vc	fz (mm/z) / Ø						
			2	3	4	6	8	10	12		2	3	4	6	8	10	12
P	≤ 850 N/mm ²	100	0,012	0,018	0,024	0,036	0,048	0,060	0,072	160	0,008	0,012	0,016	0,023	0,031	0,039	0,047
	≥ 850 N/mm ²	70	0,012	0,018	0,024	0,036	0,048	0,060	0,072	110	0,007	0,011	0,014	0,022	0,029	0,036	0,043
H	≤ 55 HRC	50	0,010	0,015	0,020	0,030	0,040	0,050	0,060	80	0,006	0,009	0,012	0,018	0,024	0,030	0,036
	55 - 63 HRC	90	0,013	0,020	0,026	0,039	0,052	0,065	0,078	150	0,008	0,012	0,016	0,023	0,031	0,039	0,047
K	≥ 240 HB	220	0,030	0,045	0,060	0,090	0,120	0,150	0,180	360	0,018	0,027	0,036	0,054	0,072	0,090	0,108

Solid carbide HSC radius milling cutters



Ball nose hard profile cutters GF 300 B

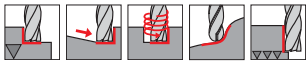
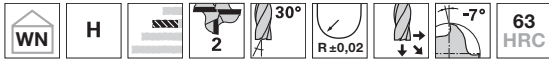

P ○ **GUHRING NAVIGATOR**
Cutting data page 332

M □

K ●

N □

S □

H ●

- neck clearance
- centre cutting

Tool material	Solid carbide
Surface	Y
Type	H
Shank form	HA

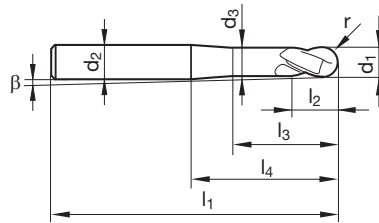

Article no. **3359**

d1 e8	d2 h6	d3	l1	l2	l3	l4	r	β	Z	Code no.
mm	mm	mm	mm	mm	mm	mm	mm	°		
0.50	3.00	0.40	38	0.7	2.6	10.0	0.25	7.40	2	0.500
0.80	3.00	0.70	38	1.2	3.5	10.0	0.40	6.60	2	0.800
1.00	3.00	0.90	38	1.5	4.0	10.0	0.50	6.10	2	1.000
1.50	3.00	1.40	38	2.2	5.5	10.0	0.75	4.70	2	1.500
2.00	6.00	1.90	57	3.0	9.4	21.0	1.00	5.80	2	2.000
3.00	6.00	2.70	57	5.0	11.6	21.0	1.50	4.40	2	3.000
4.00	6.00	3.70	57	6.0	14.5	21.0	2.00	3.10	2	4.000
5.00	6.00	4.70	57	8.0	17.3	21.0	2.50	1.60	2	5.000
6.00	6.00	5.70	57	9.0	20.0	21.0	3.00		2	6.000
8.00	8.00	7.70	63	12.0	26.0	27.0	4.00		2	8.000
10.00	10.00	9.50	72	15.0	30.0	32.0	5.00		2	10.000
12.00	12.00	11.50	83	18.0	36.0	38.0	6.00		2	12.000
16.00	16.00	15.50	92	24.0	42.0	44.0	8.00		2	16.000

Solid carbide HSC radius milling cutters

ISO	Hardness	vc	fz (mm/z) / Ø														
			2	3	4	6	8	10	12								
P	≤ 850 N/mm ²	200	0,024	0,036	0,048	0,072	0,096	0,120	0,144	320	0,016	0,023	0,031	0,047	0,062	0,078	0,094
	≥ 850 N/mm ²	130	0,024	0,036	0,048	0,072	0,096	0,120	0,144		220	0,014	0,022	0,029	0,043	0,058	0,072
H	≤ 55 HRC	90	0,020	0,030	0,040	0,060	0,080	0,100	0,120	160	0,012	0,018	0,024	0,036	0,048	0,060	0,072
	55 - 63 HRC	180	0,026	0,039	0,052	0,078	0,104	0,130	0,156		300	0,016	0,023	0,031	0,047	0,062	0,078
K	≥ 240 HB	220	0,030	0,045	0,060	0,090	0,120	0,150	0,180	360	0,018	0,027	0,036	0,054	0,072	0,090	0,108

Ball nose hard profile cutters GF 300 B

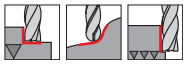
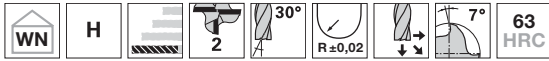

P **GUHRING NAVIGATOR**
M Cutting data page 332
K
N
S
H • neck clearance
 • centre cutting

Tool material	Solid carbide
Surface	
Type	H
Shank form	HA

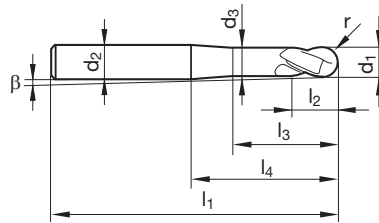

Article no. **3360**

d1 e8	d2 h6	d3	l1	l2	l3	l4	r	β	Z	Code no.
mm	mm	mm	mm	mm	mm	mm	mm	°		
3.00	6.00	2.70	75	5.0	20.0	39.0	1.50	2.30	2	3.000
4.00	6.00	3.70	75	6.0	20.0	39.0	2.00	1.60	2	4.000
5.00	6.00	4.70	75	8.0	20.0	39.0	2.50	0.80	2	5.000
6.00	6.00	5.70	75	9.0	38.0	39.0	3.00		2	6.000
8.00	8.00	7.70	100	12.0	63.0	64.0	4.00		2	8.000
10.00	10.00	9.50	100	15.0	58.0	60.0	5.00		2	10.000
12.00	12.00	11.50	150	18.0	103.0	105.0	6.00		2	12.000
16.00	16.00	15.50	150	24.0	100.0	102.0	8.00		2	16.000

Solid carbide HSC radius milling cutters

ISO	Hardness	vc	fz (mm/z) / Ø							vc	fz (mm/z) / Ø						
			2	3	4	6	8	10	12		2	3	4	6	8	10	12
P	≤ 850 N/mm ²	100	0,012	0,018	0,024	0,036	0,048	0,060	0,072	160	0,008	0,012	0,016	0,023	0,031	0,039	0,047
	≥ 850 N/mm ²	70	0,012	0,018	0,024	0,036	0,048	0,060	0,072		110	0,007	0,011	0,014	0,022	0,029	0,036
H	≤ 55 HRC	50	0,010	0,015	0,020	0,030	0,040	0,050	0,060	80	0,006	0,009	0,012	0,018	0,024	0,030	0,036
	55 - 63 HRC	90	0,013	0,020	0,026	0,039	0,052	0,065	0,078		150	0,008	0,012	0,016	0,023	0,031	0,039
K	≥ 240 HB	220	0,030	0,045	0,060	0,090	0,120	0,150	0,180	360	0,018	0,027	0,036	0,054	0,072	0,090	0,108



Ball nose hard profile cutters GF 300 B

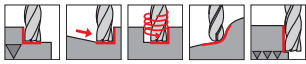
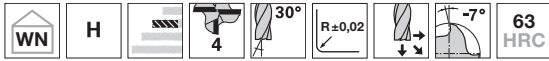

P ○ **GUHRING NAVIGATOR**
Cutting data page 332

M □

K ●

N □

S □

H ●

- neck clearance
- centre cutting

Tool material	Solid carbide
Surface	Y
Type	H
Shank form	HA

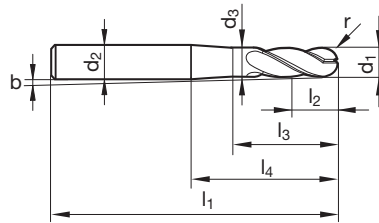

Article no. **4246**

d1 e8	d2 h6	d3	l1	l2	l3	l4	r	β	Z	Code no.
mm	mm	mm	mm	mm	mm	mm	mm	°		
2.00	6.00	1.90	57	3.0	10.0	21.0	1.00	5.80	4	2.000
3.00	6.00	2.80	57	3.5	14.0	21.0	1.50	4.40	4	3.000
4.00	6.00	3.80	57	4.0	16.0	21.0	2.00	3.10	4	4.000
6.00	6.00	5.70	57	6.0	20.0	21.0	3.00		4	6.000
8.00	8.00	7.70	63	7.0	26.0	27.0	4.00		4	8.000
12.00	12.00	11.50	83	10.0	36.0	38.0	6.00		4	12.000

ISO	Hardness	vc	fz (mm/z) / Ø							vc	fz (mm/z) / Ø						
			2	3	4	6	8	10	12		2	3	4	6	8	10	12
P	≤ 850 N/mm ²	200	0,024	0,036	0,048	0,072	0,096	0,120	0,144	320	0,016	0,023	0,031	0,047	0,062	0,078	0,094
	≥ 850 N/mm ²	130	0,024	0,036	0,048	0,072	0,096	0,120	0,144	220	0,014	0,022	0,029	0,043	0,058	0,072	0,086
H	≤ 55 HRC	90	0,020	0,030	0,040	0,060	0,080	0,100	0,120	160	0,012	0,018	0,024	0,036	0,048	0,060	0,072
	55 - 63 HRC	180	0,026	0,039	0,052	0,078	0,104	0,130	0,156	300	0,016	0,023	0,031	0,047	0,062	0,078	0,094
K	≥ 240 HB	220	0,030	0,045	0,060	0,090	0,120	0,150	0,180	360	0,018	0,027	0,036	0,054	0,072	0,090	0,108

Solid carbide HSC radius milling cutters

Ball nose hard profile cutters GF 300 B

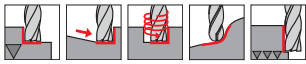
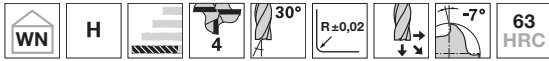

P **GUHRING NAVIGATOR**
M Cutting data page 332
K
N
S
H • neck clearance
 • centre cutting

Tool material	Solid carbide
Surface	
Type	H
Shank form	cyl.

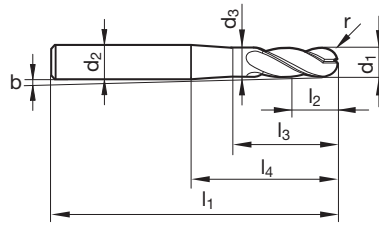

Article no. **4247**

d1 e8	d2 h6	d3	l1	l2	l3	l4	r	β	Z	Code no.
mm	mm	mm	mm	mm	mm	mm	mm	°		
2.00	6.00	1.90	80	3.0	10.0	40.0	1.00	3.00	4	2.000
3.00	6.00	2.80	80	3.5	14.0	40.0	1.50	2.30	4	3.000
4.00	6.00	3.80	80	4.0	16.0	40.0	2.00	1.60	4	4.000
5.00	6.00	4.80	100	5.0	18.0	50.0	2.50	0.70	4	5.000
6.00	6.00	5.70	100	6.0	49.0	50.0	3.00		4	6.000
8.00	8.00	7.70	100	7.0	49.0	50.0	4.00		4	8.000
10.00	10.00	9.50	100	8.0	48.0	50.0	5.00		4	10.000
12.00	12.00	11.50	120	10.0	68.0	70.0	6.00		4	12.000

Solid carbide HSC radius milling cutters

ISO	Hardness	vc	fz (mm/z) / Ø								vc	fz (mm/z) / Ø							
			2	3	4	6	8	10	12	2		3	4	6	8	10	12		
P	≤ 850 N/mm ²	100	0,012	0,018	0,024	0,036	0,048	0,060	0,072		160	0,008	0,012	0,016	0,023	0,031	0,039	0,047	
	≥ 850 N/mm ²	70	0,012	0,018	0,024	0,036	0,048	0,060	0,072		110	0,007	0,011	0,014	0,022	0,029	0,036	0,043	
H	≤ 55 HRC	50	0,010	0,015	0,020	0,030	0,040	0,050	0,060		80	0,006	0,009	0,012	0,018	0,024	0,030	0,036	
	55 - 63 HRC	90	0,013	0,020	0,026	0,039	0,052	0,065	0,078		150	0,008	0,012	0,016	0,023	0,031	0,039	0,047	
K	≥ 240 HB	220	0,030	0,045	0,060	0,090	0,120	0,150	0,180	360	0,018	0,027	0,036	0,054	0,072	0,090	0,108		



Die sinking cutter holder GF 200 WP

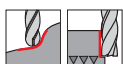

- P** •
- M** •
- K** •
- N** ○
- S** •
- H** •

GUHRING NAVIGATOR

Cutting data page 332

Surface	Ⓝ
Type	GF 200
Shank form	HA

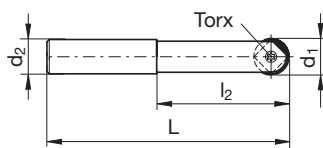

Article no. **1941**

d1 ±0,015	d2 h6	l1	l2	Torx	Code no.
mm	mm	mm	mm		
10.00	10.00	95	45	T8	10.000
12.00	12.00	110	50	T15	12.000
16.00	16.00	125	65	T20	16.000
20.00	20.00	140	75	T20	20.000
25.00	25.00	165	90	T30	25.000
32.00	32.00	185	105	T30	32.000

ISO	Hardness	vc	fz (mm/z) / Ø							vc	fz (mm/z) / Ø						
			2	3	4	6	8	10	12		2	3	4	6	8	10	12
P	≤ 850 N/mm ²	180	0,023	0,034	0,045	0,068	0,090	0,113	0,135	300	0,014	0,020	0,027	0,041	0,054	0,068	0,081
	≥ 850 N/mm ²	150	0,018	0,027	0,036	0,054	0,072	0,090	0,108	240	0,012	0,018	0,023	0,035	0,047	0,059	0,070
H	≤ 55 HRC	100	0,018	0,027	0,036	0,054	0,072	0,090	0,108	170	0,011	0,016	0,022	0,032	0,043	0,054	0,065
M	≤ 750 N/mm ²	120	0,020	0,029	0,039	0,049	0,059	0,078	0,098	200	0,012	0,018	0,023	0,035	0,047	0,059	0,070
	≥ 750 N/mm ²	60	0,015	0,023	0,030	0,045	0,060	0,075	0,090	110	0,009	0,014	0,018	0,027	0,036	0,045	0,054
S	Ni-based	40	0,015	0,023	0,030	0,045	0,060	0,075	0,090	60	0,009	0,014	0,018	0,027	0,036	0,045	0,054
	Ti-based	75	0,018	0,027	0,036	0,054	0,072	0,090	0,108	130	0,011	0,016	0,022	0,032	0,043	0,054	0,065
K	≤ 240 HB	165	0,023	0,034	0,045	0,068	0,090	0,113	0,135	270	0,014	0,020	0,027	0,041	0,054	0,068	0,081
	≥ 240 HB	135	0,020	0,029	0,039	0,059	0,078	0,098	0,117	230	0,012	0,018	0,023	0,035	0,047	0,059	0,070
N	≥ 7 % Si	225	0,023	0,034	0,045	0,068	0,090	0,113	0,135	380	0,014	0,020	0,027	0,041	0,054	0,068	0,081

Solid carbide HSC radius milling cutters

Die sinking cutter holder GF 200 WP

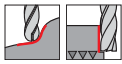

P • **GUHRING NAVIGATOR**
M • Cutting data page 332
K •
N ○
S •
H •

Surface	Ni
Type	GF 200
Shank form	HA

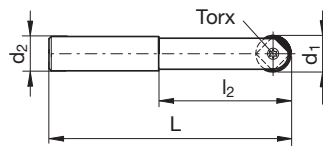

Article no. **1942**

d1 ±0,015	d2 h6	l1	l2	Torx	Code no.
mm	mm	mm	mm		
10.00	12.00	150	35	T8	10.000
12.00	16.00	160	60	T15	12.000
16.00	20.00	174	70	T20	16.000
20.00	25.00	189	80	T20	20.000
25.00	32.00	210	100	T30	25.000

Solid carbide HSC radius milling cutters

ISO	Hardness	vc	fz (mm/z) / Ø							vc	fz (mm/z) / Ø						
			2	3	4	6	8	10	12		2	3	4	6	8	10	12
P	≤ 850 N/mm ²	180	0,023	0,034	0,045	0,068	0,090	0,113	0,135	300	0,014	0,020	0,027	0,041	0,054	0,068	0,081
	≥ 850 N/mm ²	150	0,018	0,027	0,036	0,054	0,072	0,090	0,108	240	0,012	0,018	0,023	0,035	0,047	0,059	0,070
H	≤ 55 HRC	100	0,018	0,027	0,036	0,054	0,072	0,090	0,108	170	0,011	0,016	0,022	0,032	0,043	0,054	0,065
M	≤ 750 N/mm ²	120	0,020	0,029	0,039	0,049	0,059	0,078	0,098	200	0,012	0,018	0,023	0,035	0,047	0,059	0,070
	≥ 750 N/mm ²	60	0,015	0,023	0,030	0,045	0,060	0,075	0,090	110	0,009	0,014	0,018	0,027	0,036	0,045	0,054
S	Ni-based	40	0,015	0,023	0,030	0,045	0,060	0,075	0,090	60	0,009	0,014	0,018	0,027	0,036	0,045	0,054
	Ti-based	75	0,018	0,027	0,036	0,054	0,072	0,090	0,108	130	0,011	0,016	0,022	0,032	0,043	0,054	0,065
K	≤ 240 HB	165	0,023	0,034	0,045	0,068	0,090	0,113	0,135	270	0,014	0,020	0,027	0,041	0,054	0,068	0,081
	≥ 240 HB	135	0,020	0,029	0,039	0,059	0,078	0,098	0,117	230	0,012	0,018	0,023	0,035	0,047	0,059	0,070
N	≥ 7 % Si	225	0,023	0,034	0,045	0,068	0,090	0,113	0,135	380	0,014	0,020	0,027	0,041	0,054	0,068	0,081



Indexable inserts round



Tool material	Cermet	Solid carbide
Surface	○	⦿

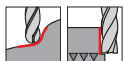

- P** • **GUHRING NAVIGATOR**
M • Cutting data page 332
K •
N ○
S •
H • • applicable twice

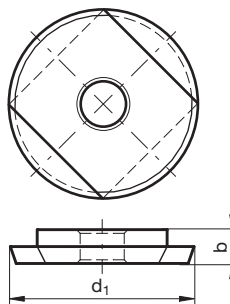

Article no. **1947** **2520**

d1 ±0,015	b	Code no.
mm	mm	
10.00	2.5	10.000
12.00	2.5	12.000
16.00	3.2	16.000
20.00	4.0	20.000
25.00	4.6	25.000
32.00	5.0	32.000

ISO	Hardness	vc	fz (mm/z) / Ø							vc	fz (mm/z) / Ø						
			2	3	4	6	8	10	12		2	3	4	6	8	10	12
P	≤ 850 N/mm ²	180	0,023	0,034	0,045	0,068	0,090	0,113	0,135	300	0,014	0,020	0,027	0,041	0,054	0,068	0,081
	≥ 850 N/mm ²	150	0,018	0,027	0,036	0,054	0,072	0,090	0,108		240	0,012	0,018	0,023	0,035	0,047	0,059
H	≤ 55 HRC	100	0,018	0,027	0,036	0,054	0,072	0,090	0,108	170	0,011	0,016	0,022	0,032	0,043	0,054	0,065
		120	0,020	0,029	0,039	0,049	0,059	0,078	0,098		200	0,012	0,018	0,023	0,035	0,047	0,059
M	≤ 750 N/mm ²	60	0,015	0,023	0,030	0,045	0,060	0,075	0,090	110	0,009	0,014	0,018	0,027	0,036	0,045	0,054
	≥ 750 N/mm ²	40	0,015	0,023	0,030	0,045	0,060	0,075	0,090		60	0,009	0,014	0,018	0,027	0,036	0,045
S	Ni-based	75	0,018	0,027	0,036	0,054	0,072	0,090	0,108	130	0,011	0,016	0,022	0,032	0,043	0,054	0,065
	Ti-based	165	0,023	0,034	0,045	0,068	0,090	0,113	0,135		270	0,014	0,020	0,027	0,041	0,054	0,068
K	≤ 240 HB	135	0,020	0,029	0,039	0,059	0,078	0,098	0,117	230	0,012	0,018	0,023	0,035	0,047	0,059	0,070
	≥ 240 HB	225	0,023	0,034	0,045	0,068	0,090	0,113	0,135		380	0,014	0,020	0,027	0,041	0,054	0,068
N	≥ 7 % Si																

Solid carbide HSC radius milling cutters

Clamping screws for diesinking cutter holders

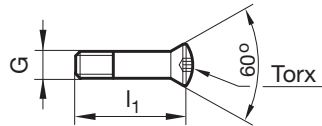

Article no. **1691**

G	Torx	l1 mm	Code no.
M3	T8	8.500	3.000
M 4 X0.5	T15	10.200	4.000
M 5 X0.5	T20	12.800	5.000
M 5 X0.5	T20	15.400	5.001
M12 X 1.5	T30	20.400	6.000
M 8 X0.75	T30	24.800	8.000

Torx screwdriver

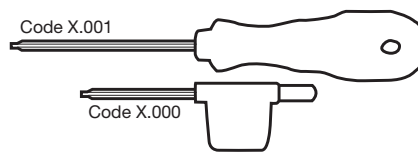

Article no. **1612**

Torx	Code no.
T5	5.001
T6	6.000
T6	6.001
T7	7.001
T8	8.000
T8	8.001
T9	9.001
T10	10.001
T15	15.000
T15	15.001
T20	20.001
T25	25.001
T30	30.001

Solid carbide HSC radius milling cutters



RF 100

 **SPEED**

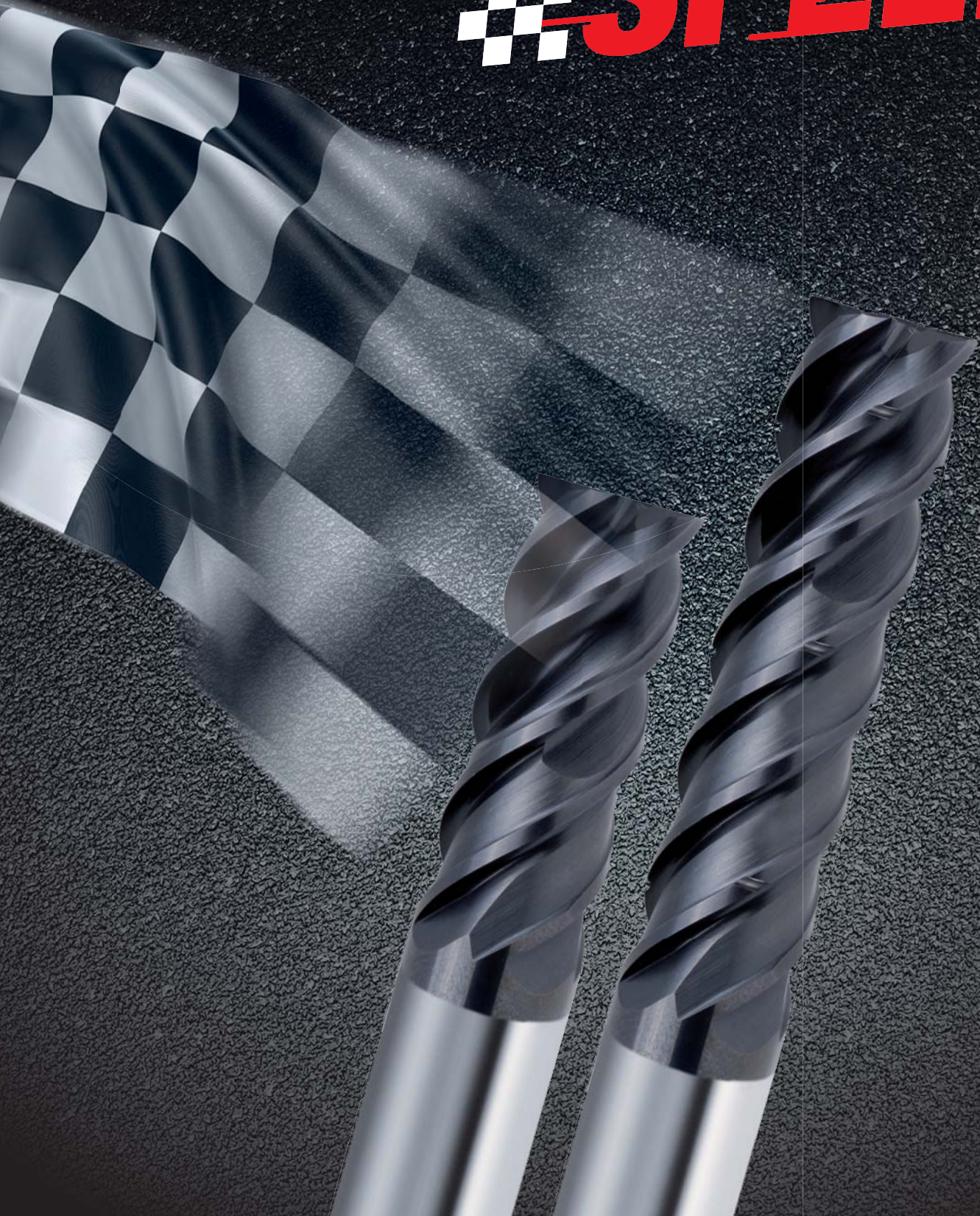



SOLID CARBIDE UNIVERSAL MILLING CUTTERS

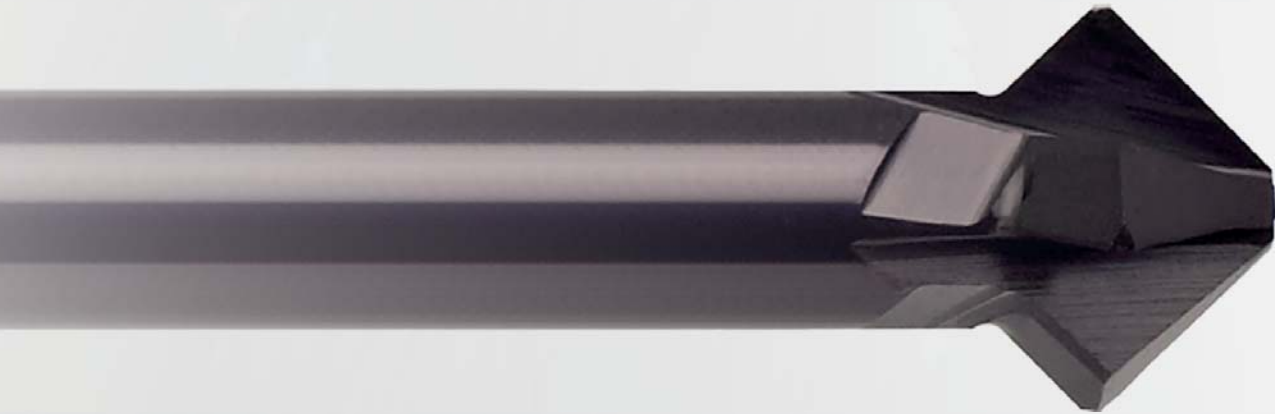

P	M	K	N	S	H	Tool illustration	Z	Hardness	Shank form	Length	Helix angle °	Tool material	Surface	d1/mm	Article no.	Page
•	•	•	•	•	○		4	55 HRC	HA		7°	VHM	A	4.000 - 12.000	6711	226
•	•	•	•	•	○		4	55 HRC	HB		7°	VHM	A	4.000 - 12.000	6712	226
•	•	•	•	•	○		4	55 HRC	HA		7°	VHM	A	4.000 - 12.000	6713	227
•	•	•	•	•	○		4	55 HRC	HB		7°	VHM	A	4.000 - 12.000	3396	227
•	•	•	•	•	•		4	63 HRC	HA		7°	VHM	Y	4.000 - 12.000	6784	228
•	•	•	•	•	•		4	63 HRC	HB		7°	VHM	Y	4.000 - 12.000	6785	228
•	•	•	•	•	○		4	55 HRC	HA		7°	VHM	A	4.000 - 12.000	6714	229
•	•	•	•	•	○		4	55 HRC	HB		7°	VHM	A	4.000 - 12.000	6715	229
•	•	•	•	•	○		6	55 HRC	HA		7°	VHM	A	6.000 - 20.000	6786	230
•	•	•	•	•	○		6	55 HRC	HB		7°	VHM	A	6.000 - 20.000	6787	230
•	•	•	•	•	•		4	55 HRC	HA		0°	VHM	a	3.000 - 12.000	495	231
•	•	•	•	•	•		4	55 HRC	HA		7°	VHM	F	6.000 - 20.000	6788	232
•	•	•	•	•	•		2		HA		30°	VHM	○	2.000 - 20.000	3194	233
•	•	•	•	•	•		2		HA		30°	VHM	F	2.000 - 20.000	3633	233
•	•	•	•	•	•		2		HB		30°	VHM	○	2.000 - 20.000	3294	234
•	•	•	•	•	•		2		HB		30°	VHM	F	2.000 - 20.000	3634	234
•	•	•	•	•	•		2		HA		30°	VHM	○	1.000 - 20.000	3195	235
•	•	•	•	•	•		2		HA		30°	VHM	F	1.000 - 20.000	3635	235
•	•	•	•	•	•		2		HB		30°	VHM	○	2.000 - 20.000	3295	236
•	•	•	•	•	•		2		HB		30°	VHM	F	2.000 - 20.000	3154	236
•	•	•	•	•	•		2		-HA		30°	VHM	○	2.000 - 20.000	3212	237
•	•	•	•	•	•		2		-HA		30°	VHM	F	2.000 - 20.000	3709	237

Solid carbide universal milling cutters



P	M	K	N	S	H	Tool illustration	Z	Hardness	Shank form	Length	Helix angle °	Tool material	Surface	d1/mm	Article no.	Page
Slot drills (2-fluted)																
•	•	•	•					-HA			30°	VHM	○	2.000 - 20.000	3303	238
•	•	•	•					-HA			30°	VHM	⊙	2.000 - 20.000	3676	238
XL slot drills (2-fluted)																
•	•	•	•					HA			30°	VHM	○	3.000 - 20.000	3011	239
•	•	•	•					HA			30°	VHM	⊙	3.000 - 20.000	3021	239
Al slot drills (2-fluted)																
		•						HA			45°	VHM	○	3.000 - 20.000	3310	240
		•						HB			45°	VHM	○	3.000 - 20.000	3126	240
		•						HA			45°	VHM	○	3.000 - 20.000	3309	241
		•						HB			45°	VHM	○	3.000 - 20.000	3059	241
XL Al slot drills (2-fluted)																
		•						HA			45°	VHM	○	5.000 - 16.000	3358	242
Slot drills (3-fluted)																
•	•	•	•					HA			30°	VHM	○	2.000 - 20.000	3555	243
•	•	•	•					HA			30°	VHM	⊙	2.000 - 20.000	3558	243
•	•	•	•					HB			30°	VHM	○	2.000 - 20.000	3296	244
•	•	•	•					HB			30°	VHM	⊙	2.000 - 20.000	3719	244
•	•	•	•					HA			30°	VHM	○	2.000 - 20.000	3559	245
•	•	•	•					HA			30°	VHM	⊙	2.000 - 20.000	3560	245
•	•	•	•					HB			30°	VHM	○	2.000 - 20.000	3297	246
•	•	•	•					HB			30°	VHM	⊙	2.000 - 20.000	3720	246
•	•	•	•					-HA			30°	VHM	○	2.000 - 20.000	3307	247
•	•	•	•					-HA			30°	VHM	⊙	2.000 - 20.000	3677	247
•	•	•	•					-HA			30°	VHM	○	2.000 - 20.000	3220	248
•	•	•	•					-HA			30°	VHM	⊙	2.000 - 20.000	3711	248

Solid carbide universal milling cutters

P	M	K	N	S	H	Tool illustration	Z	Hardness	Shank form	Length	Helix angle °	Tool material	Surface	d1/mm	Article no.	Page
Slot drills XL (3-fluted)																
•	•	•	•	•			3	HA			30°	VHM	○	3.000 - 20.000	3314	249
•	•	•	•	•			3	HA			30°	VHM	Ⓡ	3.000 - 20.000	3680	249
Mini slot drills (3-fluted)																
•	•	○	•	•			3	HA/HB			30°	VHM	Ⓡ	0.300 - 20.000	3684	250
•	•	○	•	○			3	HA/HB			45°	VHM	Ⓡ	1.000 - 10.000	3686	251
End mills (4-fluted)																
•	•	•	•	•			4	HA			30°	VHM	○	2.000 - 20.000	3198	252
•	•	•	•	•			4	HA			30°	VHM	Ⓡ	2.000 - 20.000	3637	252
•	•	•	•	•			4	HB			30°	VHM	○	2.000 - 20.000	3298	253
•	•	•	•	•			4	HB			30°	VHM	Ⓡ	2.000 - 20.000	3721	253
•	•	•	•	•			4	HA			30°	VHM	○	2.000 - 20.000	3197	254
•	•	•	•	•			4	HA			30°	VHM	Ⓡ	2.000 - 20.000	3649	254
•	•	•	•	•			4	HB			30°	VHM	○	2.000 - 20.000	3299	255
•	•	•	•	•			4	HB			30°	VHM	Ⓡ	2.000 - 20.000	3722	255
•	•	•	•	•			4	-HA			30°	VHM	○	2.000 - 20.000	3304	256
•	•	•	•	•			4	-HA			30°	VHM	Ⓡ	2.000 - 20.000	3678	256
•	•	•	•	•			4	-HA			30°	VHM	○	4.500 - 20.000	3257	257
•	•	•	•	•			4	-HA			30°	VHM	Ⓡ	4.500 - 20.000	3713	257
XL slot drills (2-fluted)																
•	•	•	•	•			4	HA			30°	VHM	○	3.000 - 20.000	3012	258
•	•	•	•	•			4	HA			30°	VHM	Ⓡ	3.000 - 20.000	3023	258
Ratio end mill sets RF 100 Diver																
•	•	•	•	•			4	48 HRC	HA		36° 38° 37°	VHM	Ⓡ		6755	259

Solid carbide universal milling cutters



P	M	K	N	S	H	Tool illustration	Z	Hardness	Shank form	Length	Helix angle °	Tool material	Surface	d1/mm	Article no.	Page
---	---	---	---	---	---	-------------------	---	----------	------------	--------	---------------	---------------	---------	-------	-------------	------

Ratio end mill sets RF 100 Diver

•	•	•	•	•			4	48 HRC	HB		36° 38° 37°	VHM	Y		6754	260
---	---	---	---	---	--	--	---	--------	----	--	-------------------	-----	---	--	------	-----

Ratio end mill sets RF 100 Speed

•	•						4		HA		48°	VHM	A		6778	261
•	•						4		HB		48°	VHM	A		6780	262
•	•						4		HA		48°	VHM	A		6777	263
•	•						4		HB		48°	VHM	A		6781	264

Ratio end mill sets RF 100 U Z3

•	•	•	•	•	○		3		HB		41° 43° 45°	VHM	F		4372	265
---	---	---	---	---	---	--	---	--	----	--	-------------------	-----	---	--	------	-----

Ratio end mill sets RF 100 U

•	○	•	○	○			4	48 HRC	HB		35° 38°	VHM	F		5634	266
•	○	•	○	○			4		HA		35° 38°	VHM	F		5645	267

Solid carbide universal milling cutters



P	M	K	N	S	H	Tool illustration	Z	Hardness	Shank form	Length	Helix angle °	Tool material	Surface	d1/mm	Article no.	Page
•	○	•	○	○			4	48 HRC	HB		35° 38°	VHM	F		5635	268
•	•	○	•				4		HB		36° 38°	VHM	a		4370	269
•	•	•	○	○			4		HB		36° 38°	VHM	a		4371	270
•	•	•	○	•	○		4		HA		30°	VHM	F		4352	271
•	•	•	○	•			4		HA		30°	VHM	F		4345	272
•	•	•	○	•			4		HB		30°	VHM	F		4344	273
•	•		○				5-6	48 HRC	HA		45°	VHM	F		4353	274

Solid carbide universal milling cutters



P	M	K	N	S	H	Tool illustration	Z	Hardness	Shank form	Length	Helix angle °	Tool material	Surface	d1/mm	Article no.	Page
---	---	---	---	---	---	-------------------	---	----------	------------	--------	---------------	---------------	---------	-------	-------------	------

High-performance roughing end mills RS 100 F, set

•	•						5-6	48 HRC	HA		45°	VHM	F		4348	275
•	•						5-6	48 HRC	HB		45°	VHM	F		4347	276

Slot drills (2-fluted), set

•	•	•	•				2		HB		30°	VHM	F		3798	277
---	---	---	---	--	--	--	---	--	----	--	-----	-----	---	--	------	-----

Slot drills GH 100 U (3-fluted), set

•	•	•	•	•	•		3		HB		45°	VHM	F		5636	278
---	---	---	---	---	---	--	---	--	----	--	-----	-----	---	--	------	-----

End mills (4-fluted), set

•	•	•	•				4		HB		30°	VHM	F		3799	279
---	---	---	---	--	--	--	---	--	----	--	-----	-----	---	--	------	-----

Solid carbide universal milling cutters

Chamfering milling cutters

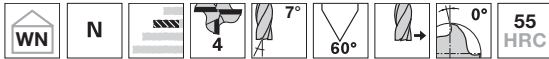

Tool material	Solid carbide	
Surface	A	A
Type	N	N
Shank form	HA	HB

P • **GUHRING NAVIGATOR**
M • Cutting data page 335
K •
N •
S •
H ○

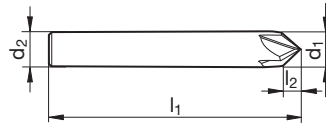

Article no.					6711	6712
d1 js9	d2 h6	l1	l2	Z	Code no.	
mm	mm	mm	mm			
4.000	4.000	50.000	3.500	4	4.000	
6.000	6.000	57.000	5.200	4	6.000	
8.000	8.000	63.000	7.000	4	8.000	
10.000	10.000	72.000	8.700	4	10.000	
12.000	12.000	83.000	10.400	4	12.000	

ISO	Hardness	vc	fz (mm/z) / Ø							vc	fz (mm/z) / Ø								
			Chamfering						ap/ae max = 0,25 x D		De-burring						ap/ae max = 0,05 x D		
			3	6	8	10	12	16	20				3	6	8	10	12	16	20
P	≤ 850 N/mm ²	192	0,018	0,036	0,048	0,06	0,08	0,10	0,13	250	0,030	0,060	0,080	0,11	0,13	0,17	0,21		
	≥ 850 N/mm ²	140	0,016	0,032	0,042	0,06	0,07	0,09	0,12	180	0,026	0,053	0,070	0,10	0,12	0,16	0,20		
M	≤ 750 N/mm ²	120	0,013	0,025	0,034	0,05	0,05	0,07	0,09	160	0,021	0,042	0,056	0,08	0,09	0,12	0,15		
	≥ 750 N/mm ²	80	0,009	0,019	0,025	0,04	0,04	0,06	0,07	100	0,016	0,032	0,042	0,06	0,07	0,10	0,12		
K	≤ 240 HB	170	0,017	0,033	0,044	0,06	0,07	0,09	0,12	230	0,028	0,056	0,074	0,10	0,12	0,16	0,20		
N	≥ 7% Si	250	0,023	0,047	0,062	0,08	0,10	0,13	0,17	330	0,039	0,078	0,104	0,14	0,17	0,22	0,28		

Solid carbide universal milling cutters



Chamfering milling cutters

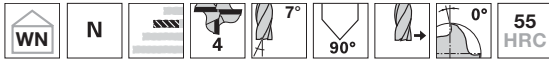

Tool material	Solid carbide	
Surface	A	A
Type	N	N
Shank form	HA	HB

P • **GUHRING NAVIGATOR**
M • Cutting data page 335
K •
N •
S •
H ○

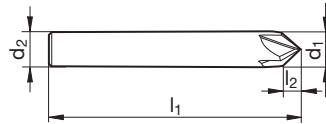

Article no. **6713** **3396**

d1 js9	d2 h6	l1	l2	Z	Code no.
mm	mm	mm	mm		
4.000	4.000	50.000	2.000	4	4.000
6.000	6.000	57.000	3.000	4	6.000
8.000	8.000	63.000	4.000	4	8.000
10.000	10.000	72.000	5.000	4	10.000
12.000	12.000	83.000	6.000	4	12.000

ISO	Hardness	vc	fz (mm/z) / Ø							vc	fz (mm/z) / Ø						
			3	6	8	10	12	16	20		3	6	8	10	12	16	20
P	≤ 850 N/mm ²	192	0,018	0,036	0,048	0,06	0,08	0,10	0,13	250	0,030	0,060	0,080	0,11	0,13	0,17	0,21
	≥ 850 N/mm ²	140	0,016	0,032	0,042	0,06	0,07	0,09	0,12	180	0,026	0,053	0,070	0,10	0,12	0,16	0,20
M	≤ 750 N/mm ²	120	0,013	0,025	0,034	0,05	0,05	0,07	0,09	160	0,021	0,042	0,056	0,08	0,09	0,12	0,15
	≥ 750 N/mm ²	80	0,009	0,019	0,025	0,04	0,04	0,06	0,07	100	0,016	0,032	0,042	0,06	0,07	0,10	0,12
K	≤ 240 HB	170	0,017	0,033	0,044	0,06	0,07	0,09	0,12	230	0,028	0,056	0,074	0,10	0,12	0,16	0,20
N	≥ 7% Si	250	0,023	0,047	0,062	0,08	0,10	0,13	0,17	330	0,039	0,078	0,104	0,14	0,17	0,22	0,28

Solid carbide universal milling cutters

Chamfering milling cutters

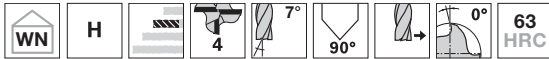

Tool material	Solid carbide	
Surface		
Type	H	H
Shank form	HA	HB

P • **GUHRING NAVIGATOR**
M • Cutting data page 335
K •
N •
S •
H •

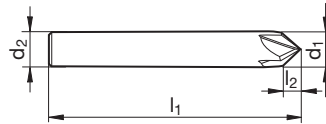

Article no. **6784** **6785**

d1 js9	d2 h6	l1	l2	Z	Code no.
mm	mm	mm	mm		
4.000	4.000	50.000	2.000	4	4.000
6.000	6.000	57.000	3.000	4	6.000
8.000	8.000	63.000	4.000	4	8.000
10.000	10.000	72.000	5.000	4	10.000
12.000	12.000	83.000	6.000	4	12.000

ISO	Hardness	vc	fz (mm/z) / Ø							vc	fz (mm/z) / Ø						
			3	6	8	10	12	16	20		3	6	8	10	12	16	20
P	≥ 850 N/mm ²	140	0,016	0,032	0,042	0,06	0,07	0,09	0,12	180	0,026	0,053	0,070	0,10	0,12	0,16	0,20
K	≥ 240 HB	150	0,014	0,028	0,037	0,05	0,06	0,08	0,10	190	0,023	0,047	0,062	0,08	0,10	0,13	0,17
H	≤ 55 HRC	50	0,010	0,020	0,026	0,04	0,04	0,06	0,07	70	0,017	0,033	0,044	0,06	0,07	0,10	0,12
	55 - 63 HRC	40	0,013	0,025	0,034	0,05	0,05	0,07	0,09	60	0,021	0,042	0,056	0,08	0,09	0,12	0,15

Solid carbide universal milling cutters



Chamfering milling cutters

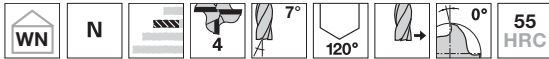

Tool material	Solid carbide	
Surface	A	A
Type	N	N
Shank form	HA	HB

P • **GUHRING NAVIGATOR**
M • Cutting data page 335
K •
N •
S •
H ○

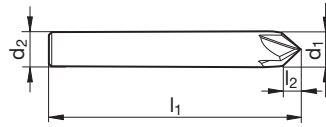

Article no. **6714** **6715**

d1 js9	d2 h6	l1	l2	Z	Code no.
mm	mm	mm	mm		
4.000	4.000	50.000	1.200	4	4.000
6.000	6.000	57.000	1.800	4	6.000
8.000	8.000	63.000	2.400	4	8.000
10.000	10.000	72.000	2.900	4	10.000
12.000	12.000	83.000	3.500	4	12.000

ISO	Hardness	vc	fz (mm/z) / Ø							vc	fz (mm/z) / Ø														
			Chamfering						ap/ae max = 0,25 x D		De-burring						ap/ae max = 0,05 x D								
			3	6	8	10	12	16		20				3	6	8		10	12	16	20				
P	≤ 850 N/mm ²	192	0,018	0,036	0,048	0,06	0,08	0,10	0,13	250	0,030	0,060	0,080	0,11	0,13	0,17	0,21	180	0,026	0,053	0,070	0,10	0,12	0,16	0,20
	≥ 850 N/mm ²	140	0,016	0,032	0,042	0,06	0,07	0,09	0,12	180	0,026	0,053	0,070	0,10	0,12	0,16	0,20	180	0,026	0,053	0,070	0,10	0,12	0,16	0,20
M	≤ 750 N/mm ²	120	0,013	0,025	0,034	0,05	0,05	0,07	0,09	160	0,021	0,042	0,056	0,08	0,09	0,12	0,15	100	0,016	0,032	0,042	0,06	0,07	0,10	0,12
	≥ 750 N/mm ²	80	0,009	0,019	0,025	0,04	0,04	0,06	0,07	100	0,016	0,032	0,042	0,06	0,07	0,10	0,12	100	0,016	0,032	0,042	0,06	0,07	0,10	0,12
K	≤ 240 HB	170	0,017	0,033	0,044	0,06	0,07	0,09	0,12	230	0,028	0,056	0,074	0,10	0,12	0,16	0,20	230	0,028	0,056	0,074	0,10	0,12	0,16	0,20
N	≥ 7% Si	250	0,023	0,047	0,062	0,08	0,10	0,13	0,17	330	0,039	0,078	0,104	0,14	0,17	0,22	0,28	330	0,039	0,078	0,104	0,14	0,17	0,22	0,28

Solid carbide universal milling cutters

Chamfering milling cutters

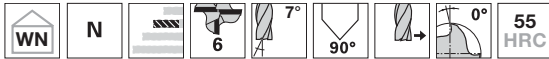

Tool material	Solid carbide	
Surface	A	A
Type	N	N
Shank form	HA	HB
	NEW	NEW

P • **GUHRING NAVIGATOR**
M • Cutting data page 335
K •
N •
S ○
H ○

- face cutting
- without centre cutting

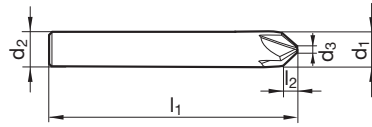

Article no. **6786** **6787**

d1 js9	d2 h6	d3	l1	l2	Z	Code no.
mm	mm	mm	mm	mm		
6.000	6.000	1.500	57.000	2.250	6	6.000
8.000	8.000	2.000	63.000	3.000	6	8.000
10.000	10.000	3.000	72.000	3.500	6	10.000
12.000	12.000	3.000	83.000	4.500	6	12.000
16.000	16.000	4.000	92.000	6.000	6	16.000
20.000	20.000	6.000	92.000	7.000	6	20.000

ISO	Hardness	vc	fz (mm/z) / Ø							vc	fz (mm/z) / Ø						
			Chamfering								De-burring						
P	≤ 850 N/mm ²	192	0,018	0,036	0,048	0,06	0,08	0,10	0,13	250	0,030	0,060	0,080	0,11	0,13	0,17	0,21
	≥ 850 N/mm ²	140	0,016	0,032	0,042	0,06	0,07	0,09	0,12	180	0,026	0,053	0,070	0,10	0,12	0,16	0,20
M	≤ 750 N/mm ²	120	0,013	0,025	0,034	0,05	0,05	0,07	0,09	160	0,021	0,042	0,056	0,08	0,09	0,12	0,15
	≥ 750 N/mm ²	80	0,009	0,019	0,025	0,04	0,04	0,06	0,07	100	0,016	0,032	0,042	0,06	0,07	0,10	0,12
K	≤ 240 HB	170	0,017	0,033	0,044	0,06	0,07	0,09	0,12	230	0,028	0,056	0,074	0,10	0,12	0,16	0,20
N	≥ 7% Si	250	0,023	0,047	0,062	0,08	0,10	0,13	0,17	330	0,039	0,078	0,104	0,14	0,17	0,22	0,28

Solid carbide universal milling cutters



Front/back deburrer 90°

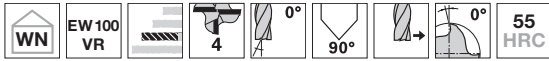

Tool material	Solid carbide
Surface	a
Type	EW 100 VR
Shank form	HA

P • **GUHRING NAVIGATOR**
M • Cutting data page 335
K •
N ○
S •
H •

- neck clearance < Ø 6.0 mm
- without centre cutting

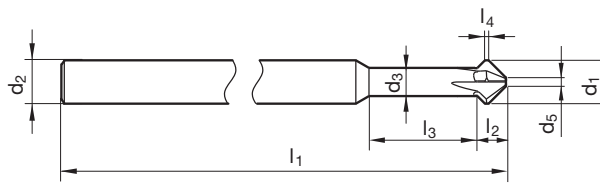

Article no. **495**

d1	d2 h6	d3	d5	l1	l2	l3	l4	Z	Code no.
mm	mm	mm	mm	mm	mm	mm	mm		
3.00	4.00	2.20	0.6	75	2.1	9.3	0.5	4	3.000
4.00	4.00	2.90	0.8	75	2.7	12.3	0.5	4	4.000
5.00	5.00	3.90	1.0	75	3.0	15.0	0.5	4	5.000
6.00	6.00	3.90	1.2	100	3.9	14.3	0.5	4	6.000
8.00	6.00	6.00	1.6	100	4.7		0.5	4	8.000
10.00	6.00	6.00	2.0	100	6.5		0.5	4	10.000
12.00	6.00	6.00	2.4	100	8.3		0.5	4	12.000

ISO	Hardness	vc	fz (mm/z) / Ø								vc	fz (mm/z) / Ø							
			3	6	8	10	12	16	20	3		6	8	10	12	16	20		
P	≤ 850 N/mm ²	192	0,018	0,036	0,048	0,06	0,08	0,10	0,13	ap/ae max = 0,25 x D	250	0,030	0,060	0,080	0,11	0,13	0,17	0,21	
	≥ 850 N/mm ²	140	0,016	0,032	0,042	0,06	0,07	0,09	0,12		180	0,026	0,053	0,070	0,10	0,12	0,16	0,20	
M	≤ 750 N/mm ²	120	0,013	0,025	0,034	0,05	0,05	0,07	0,09	ap/ae max = 0,05 x D	160	0,021	0,042	0,056	0,08	0,09	0,12	0,15	
	≥ 750 N/mm ²	80	0,009	0,019	0,025	0,04	0,04	0,06	0,07		100	0,016	0,032	0,042	0,06	0,07	0,10	0,12	
K	≤ 240 HB	170	0,017	0,033	0,044	0,06	0,07	0,09	0,12	ap/ae max = 0,05 x D	230	0,028	0,056	0,074	0,10	0,12	0,16	0,20	
N	≥ 7% Si	250	0,023	0,047	0,062	0,08	0,10	0,13	0,17		330	0,039	0,078	0,104	0,14	0,17	0,22	0,28	

Solid carbide universal milling cutters

Quadrant milling cutters



Tool material	Solid carbide
Surface	F
Type	N
Shank form	HA

P • **GUHRING NAVIGATOR**
M • Cutting data page 335
K •
N •
S ○
H • • without centre cutting

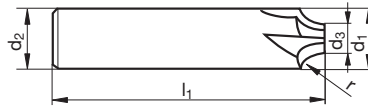

Article no. **6788**

d1	r	d2	d3	l1	Z	Code no.
mm	mm	mm	mm	mm		
6.00	0.50	6.00	5.0	50	4	6.005
6.00	1.00	6.00	4.0	50	4	6.010
8.00	1.50	8.00	5.0	58	4	8.015
10.00	2.00	10.00	6.0	66	4	10.020
10.00	2.50	10.00	5.0	66	4	10.025
12.00	3.00	12.00	6.0	73	4	12.030
14.00	3.50	14.00	7.0	75	4	14.035
14.00	4.00	14.00	6.0	75	4	14.040
16.00	4.50	16.00	7.0	76	4	16.045
16.00	5.00	16.00	6.0	76	4	16.050
20.00	5.50	20.00	9.0	92	4	20.055
20.00	6.00	20.00	8.0	92	4	20.060

Solid carbide universal milling cutters

ISO	Hardness	vc	fz (mm/z) / Ø							vc	fz (mm/z) / Ø						
			3	6	8	10	12	16	20		3	6	8	10	12	16	20
P	≤ 850 N/mm ²	140	0,014	0,028	0,037	0,048	0,06	0,08	0,10	240	0,013	0,026	0,035	0,046	0,06	0,07	0,09
	≥ 850 N/mm ²	110	0,012	0,024	0,032	0,045	0,05	0,07	0,09	180	0,012	0,023	0,031	0,043	0,05	0,07	0,09
M	≤ 750 N/mm ²	100	0,010	0,019	0,026	0,035	0,04	0,06	0,07	160	0,009	0,018	0,025	0,033	0,04	0,05	0,07
	≥ 750 N/mm ²	70	0,008	0,015	0,020	0,029	0,03	0,05	0,06	100	0,006	0,013	0,017	0,024	0,03	0,04	0,05
K	≤ 240 HB	130	0,013	0,026	0,034	0,045	0,05	0,07	0,09	220	0,012	0,024	0,033	0,043	0,05	0,07	0,09
N	≥ 7% Si	190	0,018	0,036	0,048	0,064	0,08	0,10	0,13	320	0,017	0,034	0,046	0,062	0,07	0,10	0,12



Slot drills (2-fluted)



Tool material	Solid carbide	
Surface	○	Ⓡ
Type	N	N
Shank form	HA	HA

P • **GUHRING NAVIGATOR**
M • Cutting data page 335
K •
N •
S •
H • centre cutting

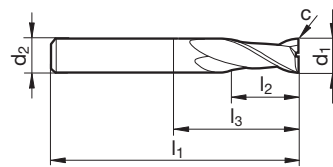

							Article no.	3194	3633
d1 h10	d2 h6	l1	l2	l3	c	Z	Code no.		
mm	mm	mm	mm	mm	mm x 45°				
2.00	6.00	50	3.0	6.4	0.02	2	2.000		
2.50	6.00	50	3.0	6.4	0.05	2	2.500		
3.00	6.00	50	4.0	8.9	0.05	2	3.000		
4.00	6.00	54	5.0	10.4	0.05	2	4.000		
5.00	6.00	54	6.0	12.9	0.05	2	5.000		
6.00	6.00	54	7.0	18.0	0.05	2	6.000		
6.50	8.00	58	8.0	17.4	0.10	2	6.500		
8.00	8.00	58	9.0	22.0	0.10	2	8.000		
10.00	10.00	66	11.0	26.0	0.10	2	10.000		
12.00	12.00	73	12.0	28.0	0.10	2	12.000		
14.00	14.00	75	14.0	30.0	0.15	2	14.000		
16.00	16.00	82	16.0	34.0	0.15	2	16.000		
18.00	18.00	84	18.0	36.0	0.15	2	18.000		
20.00	20.00	92	20.0	42.0	0.15	2	20.000		

ISO	Hardness	vc	fz (mm/z) / Ø							vc	fz (mm/z) / Ø							
			3	6	8	10	12	16	20		3	6	8	10	12	16	20	
P	≤ 850 N/mm ²	120	0,012	0,024	0,032	0,042	0,05	0,07	0,08		140	0,014	0,028	0,037	0,048	0,06	0,08	0,10
	≥ 850 N/mm ²	90	0,011	0,021	0,028	0,039	0,05	0,06	0,08		110	0,012	0,024	0,032	0,045	0,05	0,07	0,09
M	≤ 750 N/mm ²	80	0,008	0,017	0,022	0,030	0,04	0,05	0,06		100	0,010	0,019	0,026	0,035	0,04	0,06	0,07
	≥ 750 N/mm ²	50	0,006	0,013	0,017	0,024	0,03	0,04	0,05		70	0,008	0,015	0,020	0,029	0,03	0,05	0,06
K	≤ 240 HB	110	0,011	0,022	0,030	0,039	0,05	0,06	0,08	130	0,013	0,026	0,034	0,045	0,05	0,07	0,09	
N	≥ 7% Si	160	0,016	0,031	0,042	0,056	0,07	0,09	0,11	190	0,018	0,036	0,048	0,064	0,08	0,10	0,13	

Please reduce cutting values for bright finish tools: vc -50% and fz -25%

Solid carbide universal milling cutters

Slot drills (2-fluted)



Tool material	Solid carbide	
Surface	○	●
Type	N	N
Shank form	HB	HB

P • **GUHRING NAVIGATOR**
M • Cutting data page 335
K •
N •
S •
H • centre cutting

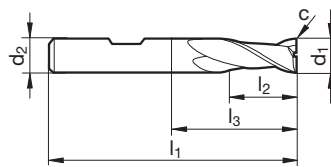

Article no. **3294** **3634**

d1 h10	d2 h6	l1	l2	l3	c	Z	Code no.
mm	mm	mm	mm	mm	mm x 45°		
2.00	6.00	50	3.0	6.4	0.02	2	2.000
2.50	6.00	50	3.0	6.4	0.05	2	2.500
3.00	6.00	50	4.0	8.9	0.05	2	3.000
4.00	6.00	54	5.0	10.4	0.05	2	4.000
5.00	6.00	54	6.0	12.9	0.05	2	5.000
6.00	6.00	54	7.0	18.0	0.05	2	6.000
6.50	8.00	58	8.0	17.4	0.10	2	6.500
8.00	8.00	58	9.0	22.0	0.10	2	8.000
10.00	10.00	66	11.0	26.0	0.10	2	10.000
12.00	12.00	73	12.0	28.0	0.10	2	12.000
14.00	14.00	75	14.0	30.0	0.15	2	14.000
16.00	16.00	82	16.0	34.0	0.15	2	16.000
18.00	18.00	84	18.0	36.0	0.15	2	18.000
20.00	20.00	92	20.0	42.0	0.15	2	20.000

Solid carbide universal milling cutters

ISO	Hardness	vc	fz (mm/z) / Ø							vc	fz (mm/z) / Ø							
			3	6	8	10	12	16	20		3	6	8	10	12	16	20	
P	≤ 850 N/mm ²	120	0,012	0,024	0,032	0,042	0,05	0,07	0,08		140	0,014	0,028	0,037	0,048	0,06	0,08	0,10
	≥ 850 N/mm ²	90	0,011	0,021	0,028	0,039	0,05	0,06	0,08		110	0,012	0,024	0,032	0,045	0,05	0,07	0,09
M	≤ 750 N/mm ²	80	0,008	0,017	0,022	0,030	0,04	0,05	0,06		100	0,010	0,019	0,026	0,035	0,04	0,06	0,07
	≥ 750 N/mm ²	50	0,006	0,013	0,017	0,024	0,03	0,04	0,05		70	0,008	0,015	0,020	0,029	0,03	0,05	0,06
K	≤ 240 HB	110	0,011	0,022	0,030	0,039	0,05	0,06	0,08	130	0,013	0,026	0,034	0,045	0,05	0,07	0,09	
N	≥ 7% Si	160	0,016	0,031	0,042	0,056	0,07	0,09	0,11	190	0,018	0,036	0,048	0,064	0,08	0,10	0,13	

Please reduce cutting values for bright finish tools: vc -50% and fz -25%



Slot drills (2-fluted)



Tool material	Solid carbide	
Surface	○	● (F)
Type	N	N
Shank form	HA	HA

P • **GUHRING NAVIGATOR**
M • Cutting data page 335
K •
N •
S
H • centre cutting

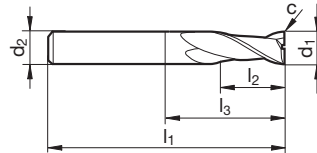

Article no. **3195** **3635**

d1 h10	d2 h6	l1	l2	l3	c	Z	Code no.
mm	mm	mm	mm	mm	mm x 45°		
1.00	3.00	38	2.0	3.9	0.02	2	1.000
1.50	3.00	38	3.0	6.4	0.02	2	1.500
2.00	6.00	57	6.0	9.4	0.02	2	2.000
2.50	6.00	57	7.0	10.4	0.05	2	2.500
2.80	6.00	57	7.0	11.9	0.05	2	2.800
3.00	6.00	57	7.0	11.9	0.05	2	3.000
3.50	6.00	57	7.0	12.4	0.05	2	3.500
3.80	6.00	57	8.0	13.4	0.05	2	3.800
4.00	6.00	57	8.0	13.4	0.05	2	4.000
4.50	6.00	57	8.0	14.9	0.05	2	4.500
4.80	6.00	57	10.0	16.9	0.05	2	4.800
5.00	6.00	57	10.0	16.9	0.05	2	5.000
5.50	6.00	57	10.0	17.4	0.05	2	5.500
5.75	6.00	57	10.0	18.4	0.05	2	5.750
6.00	6.00	57	10.0	21.0	0.05	2	6.000
6.75	8.00	63	13.0	22.4	0.10	2	6.750
7.00	8.00	63	13.0	22.4	0.10	2	7.000
7.50	8.00	63	16.0	25.4	0.10	2	7.500
7.75	8.00	63	16.0	25.4	0.10	2	7.750
8.00	8.00	63	16.0	27.0	0.10	2	8.000
8.70	10.00	72	16.0	27.4	0.10	2	8.700
9.00	10.00	72	16.0	27.4	0.10	2	9.000
9.70	10.00	72	19.0	30.4	0.10	2	9.700
10.00	10.00	72	19.0	32.0	0.10	2	10.000
11.70	12.00	83	22.0	35.4	0.10	2	11.700
12.00	12.00	83	22.0	38.0	0.10	2	12.000
13.70	14.00	83	22.0	37.4	0.15	2	13.700
14.00	14.00	83	22.0	38.0	0.15	2	14.000
14.00	16.00	92	26.0	42.0	0.15	2	14.001
15.70	16.00	92	26.0	44.0	0.15	2	15.700
16.00	16.00	92	26.0	44.0	0.15	2	16.000
18.00	18.00	92	26.0	44.0	0.15	2	18.000
18.00	20.00	104	32.0	51.0	0.15	2	18.001
20.00	20.00	104	32.0	54.0	0.15	2	20.000

Solid carbide universal milling cutters

ISO	Hardness	vc	fz (mm/z) / Ø							vc	fz (mm/z) / Ø							
			3	6	8	10	12	16	20		3	6	8	10	12	16	20	
P	≤ 850 N/mm ²	120	0,012	0,024	0,032	0,042	0,05	0,07	0,08		140	0,014	0,028	0,037	0,048	0,06	0,08	0,10
	≥ 850 N/mm ²	90	0,011	0,021	0,028	0,039	0,05	0,06	0,08		110	0,012	0,024	0,032	0,045	0,05	0,07	0,09
M	≤ 750 N/mm ²	80	0,008	0,017	0,022	0,030	0,04	0,05	0,06		100	0,010	0,019	0,026	0,035	0,04	0,06	0,07
	≥ 750 N/mm ²	50	0,006	0,013	0,017	0,024	0,03	0,04	0,05		70	0,008	0,015	0,020	0,029	0,03	0,05	0,06
K	≤ 240 HB	110	0,011	0,022	0,030	0,039	0,05	0,06	0,08		130	0,013	0,026	0,034	0,045	0,05	0,07	0,09
N	≥ 7% Si	160	0,016	0,031	0,042	0,056	0,07	0,09	0,11		190	0,018	0,036	0,048	0,064	0,08	0,10	0,13

Please reduce cutting values for bright finish tools: vc -50% and fz -25%

Slot drills (2-fluted)



Tool material	Solid carbide	
Surface	○	Ⓡ
Type	N	N
Shank form	HB	HB

P • **GUHRING NAVIGATOR**
M • Cutting data page 335
K •
N •
S
H • centre cutting

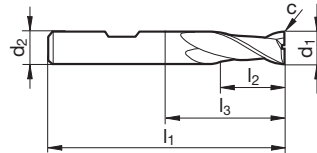

Article no. **3295** **3154**

d1 h10	d2 h6	l1	l2	l3	c	Z	Code no.
mm	mm	mm	mm	mm	mm x 45°		
2.00	6.00	57	6.0	9.4	0.02	2	2.000
2.50	6.00	57	7.0	10.4	0.05	2	2.500
2.80	6.00	57	7.0	11.9	0.05	2	2.800
3.00	6.00	57	7.0	11.9	0.05	2	3.000
3.50	6.00	57	7.0	12.4	0.05	2	3.500
3.80	6.00	57	8.0	13.4	0.05	2	3.800
4.00	6.00	57	8.0	13.4	0.05	2	4.000
4.50	6.00	57	8.0	14.9	0.05	2	4.500
4.80	6.00	57	10.0	16.9	0.05	2	4.800
5.00	6.00	57	10.0	16.9	0.05	2	5.000
5.50	6.00	57	10.0	17.4	0.05	2	5.500
5.75	6.00	57	10.0	18.4	0.05	2	5.750
6.00	6.00	57	10.0	21.0	0.05	2	6.000
6.75	8.00	63	13.0	22.4	0.10	2	6.750
7.00	8.00	63	13.0	22.4	0.10	2	7.000
7.50	8.00	63	16.0	25.4	0.10	2	7.500
7.75	8.00	63	16.0	25.4	0.10	2	7.750
8.00	8.00	63	16.0	27.0	0.10	2	8.000
8.70	10.00	72	16.0	27.4	0.10	2	8.700
9.00	10.00	72	16.0	27.4	0.10	2	9.000
9.70	10.00	72	19.0	30.4	0.10	2	9.700
10.00	10.00	72	19.0	32.0	0.10	2	10.000
11.70	12.00	83	22.0	35.4	0.10	2	11.700
12.00	12.00	83	22.0	38.0	0.10	2	12.000
13.70	14.00	83	22.0	37.4	0.15	2	13.700
14.00	14.00	83	22.0	38.0	0.15	2	14.000
15.70	16.00	92	26.0	44.0	0.15	2	15.700
16.00	16.00	92	26.0	44.0	0.15	2	16.000
18.00	18.00	92	26.0	44.0	0.15	2	18.000
20.00	20.00	104	32.0	54.0	0.15	2	20.000

Solid carbide universal milling cutters

ISO	Hardness	vc	fz (mm/z) / Ø							vc	fz (mm/z) / Ø							
			3	6	8	10	12	16	20		3	6	8	10	12	16	20	
P	≤ 850 N/mm ²	120	0,012	0,024	0,032	0,042	0,05	0,07	0,08		140	0,014	0,028	0,037	0,048	0,06	0,08	0,10
	≥ 850 N/mm ²	90	0,011	0,021	0,028	0,039	0,05	0,06	0,08		110	0,012	0,024	0,032	0,045	0,05	0,07	0,09
M	≤ 750 N/mm ²	80	0,008	0,017	0,022	0,030	0,04	0,05	0,06		100	0,010	0,019	0,026	0,035	0,04	0,06	0,07
	≥ 750 N/mm ²	50	0,006	0,013	0,017	0,024	0,03	0,04	0,05		70	0,008	0,015	0,020	0,029	0,03	0,05	0,06
K	≤ 240 HB	110	0,011	0,022	0,030	0,039	0,05	0,06	0,08	130	0,013	0,026	0,034	0,045	0,05	0,07	0,09	
N	≥ 7% Si	160	0,016	0,031	0,042	0,056	0,07	0,09	0,11	190	0,018	0,036	0,048	0,064	0,08	0,10	0,13	

Please reduce cutting values for bright finish tools: vc -50% and fz -25%



Slot drills (2-fluted)



Tool material	Solid carbide	
Surface	○	● (F)
Type	N	N
Shank form	HA	HA

P • **GUHRING NAVIGATOR**
M • Cutting data page 335
K •
N •
S
H • centre cutting

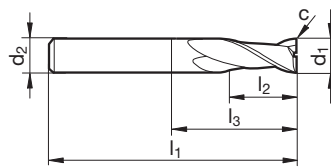

Article no. **3212** **3709**

d1 h10	d2 h6	l1	l2	l3	c	Z	Code no.
mm	mm	mm	mm	mm	mm x 45°		
2.00	2.00	32	8.0	10.5	0.02	2	2.000
2.50	2.50	32	8.0	10.5	0.05	2	2.500
3.00	3.00	32	12.0	16.0	0.05	2	3.000
3.50	3.50	32	12.0	16.5	0.05	2	3.500
4.00	4.00	40	12.0	16.5	0.05	2	4.000
4.50	4.50	50	14.0	19.5	0.05	2	4.500
5.00	5.00	50	14.0	19.5	0.05	2	5.000
5.50	5.50	50	16.0	22.0	0.05	2	5.500
6.00	6.00	50	16.0	23.0	0.05	2	6.000
6.50	6.50	60	16.0	24.0	0.10	2	6.500
7.00	7.00	60	20.0	28.0	0.10	2	7.000
7.50	7.50	60	20.0	28.0	0.10	2	7.500
8.00	8.00	60	20.0	28.0	0.10	2	8.000
8.50	8.50	60	20.0	30.0	0.10	2	8.500
9.00	9.00	60	20.0	30.0	0.10	2	9.000
9.50	9.50	70	22.0	32.0	0.10	2	9.500
10.00	10.00	70	22.0	32.0	0.10	2	10.000
11.00	11.00	70	22.0	34.0	0.10	2	11.000
12.00	12.00	70	22.0	35.0	0.10	2	12.000
13.00	13.00	75	25.0	39.0	0.15	2	13.000
14.00	14.00	75	25.0	39.0	0.15	2	14.000
15.00	15.00	75	25.0	41.0	0.15	2	15.000
16.00	16.00	75	25.0	41.0	0.15	2	16.000
18.00	18.00	100	35.0	52.0	0.15	2	18.000
20.00	20.00	100	35.0	54.0	0.15	2	20.000

Solid carbide universal milling cutters

ISO	Hardness	vc	fz (mm/z) / Ø							vc	fz (mm/z) / Ø								
			3	6	8	10	12	16	20		3	6	8	10	12	16	20		
			ap = 1,0 x D								ae = 1,0 x D			ap = 1,0 x D					
P	≤ 850 N/mm ²	120	0,012	0,024	0,032	0,042	0,05	0,07	0,08	140	0,014	0,028	0,037	0,048	0,06	0,08	0,10		
	≥ 850 N/mm ²	90	0,011	0,021	0,028	0,039	0,05	0,06	0,08	110	0,012	0,024	0,032	0,045	0,05	0,07	0,09		
M	≤ 750 N/mm ²	80	0,008	0,017	0,022	0,030	0,04	0,05	0,06	100	0,010	0,019	0,026	0,035	0,04	0,06	0,07		
	≥ 750 N/mm ²	50	0,006	0,013	0,017	0,024	0,03	0,04	0,05	70	0,008	0,015	0,020	0,029	0,03	0,05	0,06		
K	≤ 240 HB	110	0,011	0,022	0,030	0,039	0,05	0,06	0,08	130	0,013	0,026	0,034	0,045	0,05	0,07	0,09		
N	≥ 7% Si	160	0,016	0,031	0,042	0,056	0,07	0,09	0,11	190	0,018	0,036	0,048	0,064	0,08	0,10	0,13		

Please reduce cutting values for bright finish tools: vc -50% and fz -25%

Slot drills (2-fluted)



Tool material	Solid carbide	
Surface	○	●
Type	N	N
Shank form	HA	HA

P • **GUHRING NAVIGATOR**
M • Cutting data page 335
K •
N •
S •
H • centre cutting

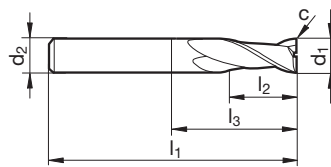

Article no. **3303** **3676**

d1 h10	d2 h6	l1	l2	l3	c	Z	Code no.
mm	mm	mm	mm	mm	mm x 45°		
2.00	2.00	32	5.0	7.5	0.02	2	2.000
2.50	2.50	32	6.0	8.5	0.05	2	2.500
3.00	3.00	38	7.0	11.0	0.05	2	3.000
3.50	3.50	50	7.0	22.0	0.05	2	3.500
4.00	4.00	50	8.0	22.0	0.05	2	4.000
4.50	4.50	50	8.0	22.0	0.05	2	4.500
5.00	5.00	50	10.0	22.0	0.05	2	5.000
5.50	5.50	57	10.0	21.0	0.05	2	5.500
6.00	6.00	57	10.0	21.0	0.05	2	6.000
6.50	6.50	60	13.0	24.0	0.10	2	6.500
7.00	7.00	60	13.0	24.0	0.10	2	7.000
7.50	7.50	63	16.0	27.0	0.10	2	7.500
8.00	8.00	63	16.0	27.0	0.10	2	8.000
8.50	8.50	67	16.0	27.0	0.10	2	8.500
9.00	9.00	67	16.0	27.0	0.10	2	9.000
9.50	9.50	72	19.0	32.0	0.10	2	9.500
10.00	10.00	72	19.0	32.0	0.10	2	10.000
11.00	11.00	83	22.0	38.0	0.10	2	11.000
12.00	12.00	83	22.0	38.0	0.10	2	12.000
13.00	13.00	83	22.0	38.0	0.15	2	13.000
14.00	14.00	83	22.0	38.0	0.15	2	14.000
15.00	15.00	92	26.0	44.0	0.15	2	15.000
16.00	16.00	92	26.0	44.0	0.15	2	16.000
18.00	18.00	92	26.0	44.0	0.15	2	18.000
20.00	20.00	104	32.0	54.0	0.15	2	20.000

Solid carbide universal milling cutters

ISO	Hardness	vc	fz (mm/z) / Ø							vc	fz (mm/z) / Ø								
			3	6	8	10	12	16	20		3	6	8	10	12	16	20		
			ap = 1,0 x D								ae = 1,0 x D			ap = 1,0 x D					
P	≤ 850 N/mm ²	120	0,012	0,024	0,032	0,042	0,05	0,07	0,08	140	0,014	0,028	0,037	0,048	0,06	0,08	0,10		
	≥ 850 N/mm ²	90	0,011	0,021	0,028	0,039	0,05	0,06	0,08	110	0,012	0,024	0,032	0,045	0,05	0,07	0,09		
M	≤ 750 N/mm ²	80	0,008	0,017	0,022	0,030	0,04	0,05	0,06	100	0,010	0,019	0,026	0,035	0,04	0,06	0,07		
	≥ 750 N/mm ²	50	0,006	0,013	0,017	0,024	0,03	0,04	0,05	70	0,008	0,015	0,020	0,029	0,03	0,05	0,06		
K	≤ 240 HB	110	0,011	0,022	0,030	0,039	0,05	0,06	0,08	130	0,013	0,026	0,034	0,045	0,05	0,07	0,09		
N	≥ 7% Si	160	0,016	0,031	0,042	0,056	0,07	0,09	0,11	190	0,018	0,036	0,048	0,064	0,08	0,10	0,13		

Please reduce cutting values for bright finish tools: vc -50% and fz -25%



XL slot drills (2-fluted)



Tool material	Solid carbide	
Surface	○	●
Type	N	N
Shank form	HA	HA

P • **GUHRING NAVIGATOR**
M • Cutting data page 335
K •
N •
S •
H • centre cutting

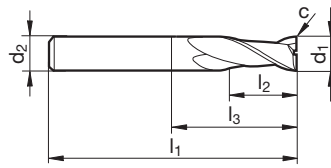

Article no. **3011** **3021**

d1 h10	d2 h6	l1	l2	l3	c	Z	Code no.
mm	mm	mm	mm	mm	mm x 45°		
3.00	3.00	75	20.0	47.0	0.05	2	3.000
4.00	4.00	75	25.0	47.0	0.05	2	4.000
5.00	5.00	75	30.0	47.0	0.05	2	5.000
6.00	6.00	75	30.0	39.0	0.05	2	6.000
8.00	8.00	100	40.0	64.0	0.10	2	8.000
10.00	10.00	100	40.0	60.0	0.10	2	10.000
12.00	12.00	150	45.0	105.0	0.10	2	12.000
14.00	14.00	150	45.0	105.0	0.15	2	14.000
14.00	16.00	150	65.0	81.0	0.15	2	14.001
16.00	16.00	150	65.0	102.0	0.15	2	16.000
18.00	18.00	150	65.0	102.0	0.15	2	18.000
18.00	20.00	150	65.0	84.0	0.15	2	18.001
20.00	20.00	150	65.0	100.0	0.15	2	20.000

ISO	Hardness	vc	fz (mm/z) / Ø							vc	fz (mm/z) / Ø							
			3	6	8	10	12	16	20		3	6	8	10	12	16	20	
P	≤ 850 N/mm ²	40	0,004	0,007	0,010	0,013	0,015	0,020	0,025		50	0,004	0,008	0,011	0,014	0,017	0,023	0,029
	≥ 850 N/mm ²	30	0,003	0,006	0,008	0,012	0,014	0,019	0,023		40	0,004	0,007	0,010	0,013	0,016	0,022	0,027
M	≤ 750 N/mm ²	30	0,003	0,005	0,007	0,009	0,011	0,014	0,018		35	0,003	0,006	0,008	0,010	0,012	0,017	0,021
	≥ 750 N/mm ²	20	0,002	0,004	0,005	0,007	0,009	0,012	0,014		25	0,002	0,005	0,006	0,009	0,010	0,014	0,017
K	≤ 240 HB	40	0,003	0,007	0,009	0,012	0,014	0,019	0,023		45	0,004	0,008	0,010	0,013	0,016	0,022	0,027
N	≥ 7% Si	55	0,005	0,009	0,012	0,017	0,020	0,027	0,034		65	0,005	0,011	0,014	0,019	0,023	0,031	0,039

Please reduce cutting values for bright finish tools: vc -50% and fz -25%

Solid carbide universal milling cutters

Al slot drills (2-fluted)

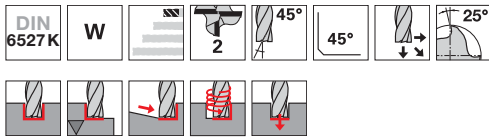

P	
M	
K	
N	•
S	
H	

GUHRING NAVIGATOR

Cutting data page 335

• centre cutting

Tool material **Solid carbide**

Surface	○	○
Type	W	W
Shank form	HA	HB

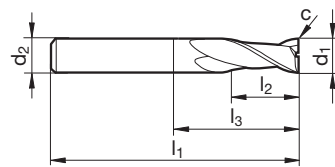

Article no. **3310** **3126**

d1 e8	d2 h6	l1	l2	l3	c	Z	Code no.
mm	mm	mm	mm	mm	mm x 45°		
3.00	6.00	50	4.0	7.9	0.03	2	3.000
4.00	6.00	54	5.0	8.9	0.03	2	4.000
5.00	6.00	54	6.0	11.4	0.03	2	5.000
6.00	6.00	54	7.0	18.0	0.03	2	6.000
8.00	8.00	58	9.0	22.0	0.05	2	8.000
10.00	10.00	66	11.0	26.0	0.05	2	10.000
12.00	12.00	73	12.0	28.0	0.10	2	12.000
14.00	14.00	75	14.0	30.0	0.10	2	14.000
16.00	16.00	82	16.0	34.0	0.10	2	16.000
18.00	18.00	84	18.0	36.0	0.10	2	18.000
20.00	20.00	92	20.0	42.0	0.10	2	20.000

ISO	Hardness	vc	fz (mm/z) / Ø							vc	fz (mm/z) / Ø						
			3	6	8	10	12	16	20		3	6	8	10	12	16	20
N	≤ 7% Si	300	0,019	0,037	0,050	0,065	0,08	0,10	0,13	350	0,021	0,043	0,057	0,075	0,09	0,12	0,15
	≥ 7% Si	160	0,013	0,025	0,034	0,046	0,06	0,07	0,09	190	0,018	0,036	0,048	0,064	0,08	0,10	0,13
NE	≤ 850 N/mm²	175	0,013	0,025	0,034	0,046	0,06	0,07	0,09	290	0,014	0,029	0,039	0,053	0,06	0,08	0,11

Solid carbide universal milling cutters



Al slot drills (2-fluted)

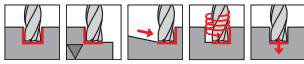

P **GUHRING NAVIGATOR**
M Cutting data page 335
K
N •
S
H • centre cutting

Tool material	Solid carbide	
Surface	○	○
Type	W	W
Shank form	HA	HB

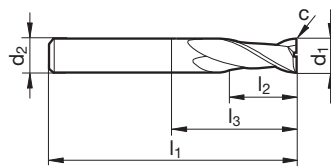

Article no. **3309** **3059**

d1 e8	d2 h6	l1	l2	l3	c	Z	Code no.
mm	mm	mm	mm	mm	mm x 45°		
3.00	6.00	57	7.0	10.9	0.03	2	3.000
4.00	6.00	57	8.0	11.9	0.03	2	4.000
5.00	6.00	57	10.0	15.4	0.03	2	5.000
6.00	6.00	57	10.0	21.0	0.03	2	6.000
8.00	8.00	63	16.0	27.0	0.05	2	8.000
10.00	10.00	72	19.0	32.0	0.05	2	10.000
12.00	12.00	83	22.0	38.0	0.10	2	12.000
14.00	14.00	83	22.0	38.0	0.10	2	14.000
14.00	16.00	92	26.0	37.4	0.10	2	14.001
16.00	16.00	92	26.0	44.0	0.10	2	16.000
18.00	18.00	92	26.0	44.0	0.10	2	18.000
18.00	20.00	104	32.0	46.0	0.10	2	18.001
20.00	20.00	104	32.0	54.0	0.10	2	20.000

ISO	Hardness	vc	fz (mm/z) / Ø							vc	fz (mm/z) / Ø						
			3	6	8	10	12	16	20		3	6	8	10	12	16	20
N	≤ 7% Si	300	0,019	0,037	0,050	0,065	0,08	0,10	0,13	350	0,021	0,043	0,057	0,075	0,09	0,12	0,15
	≥ 7% Si	160	0,013	0,025	0,034	0,046	0,06	0,07	0,09		190	0,018	0,036	0,048	0,064	0,08	0,10
NE	≤ 850 N/mm ²	175	0,013	0,025	0,034	0,046	0,06	0,07	0,09	290	0,014	0,029	0,039	0,053	0,06	0,08	0,11

Solid carbide universal milling cutters

XL AI slot drills (2-fluted)

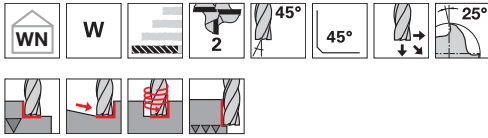

P
M
K
N •
S
H

GUHRING NAVIGATOR
Cutting data page 335

• centre cutting

Tool material	Solid carbide
Surface	○
Type	W
Shank form	HA

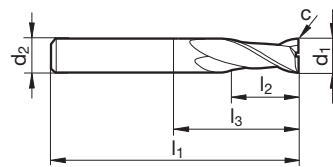

Article no. **3358**

d1 h10	d2 h6	l1	l2	l3	c	Z	Code no.
mm	mm	mm	mm	mm	mm x 45°		
5.00	5.00	75	30.0	47.0	0.03	2	5.000
6.00	6.00	75	30.0	39.0	0.03	2	6.000
8.00	8.00	100	40.0	64.0	0.05	2	8.000
10.00	10.00	100	40.0	60.0	0.05	2	10.000
12.00	12.00	150	45.0	105.0	0.10	2	12.000
16.00	16.00	150	65.0	102.0	0.10	2	16.000

ISO	Hardness	vc	fz (mm/z) / Ø							vc	fz (mm/z) / Ø						
			3	6	8	10	12	16	20		3	6	8	10	12	16	20
N	≤ 7% Si	220	0,015	0,030	0,040	0,052	0,06	0,08	0,10	270	0,009	0,019	0,025	0,033	0,039	0,052	0,065
	≥ 7% Si	130	0,013	0,025	0,033	0,045	0,05	0,07	0,09		140	0,008	0,016	0,021	0,028	0,034	0,045
NE	≤ 850 N/mm ²	70	0,010	0,020	0,027	0,037	0,04	0,06	0,07	220	0,006	0,013	0,017	0,023	0,028	0,037	0,046



Slot drills (3-fluted)



Tool material	Solid carbide	
Surface	○	⊕
Type	N	N
Shank form	HA	HA

P • **GUHRING NAVIGATOR**
M • Cutting data page 335
K •
N •
S •
H • centre cutting

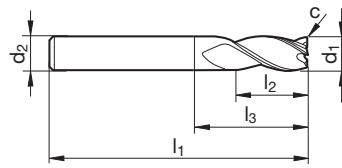

							Article no.	3555	3558
d1 h10	d2 h6	l1	l2	l3	c	Z	Code no.		
mm	mm	mm	mm	mm	mm x 45°				
2.00	6.00	50	3.0	7.4	0.02	3	2.000		
2.50	6.00	50	3.0	7.4	0.05	3	2.500		
3.00	6.00	50	4.0	8.4	0.05	3	3.000		
3.50	6.00	50	4.0	8.4	0.05	3	3.500		
4.00	6.00	54	5.0	10.4	0.05	3	4.000		
5.00	6.00	54	6.0	12.4	0.05	3	5.000		
5.50	6.00	54	7.0	14.9	0.05	3	5.500		
6.00	6.00	54	7.0	18.0	0.05	3	6.000		
7.00	8.00	58	8.0	16.9	0.10	3	7.000		
8.00	8.00	58	9.0	22.0	0.10	3	8.000		
8.50	10.00	66	10.0	20.9	0.10	3	8.500		
9.00	10.00	66	10.0	20.9	0.10	3	9.000		
10.00	10.00	66	11.0	26.0	0.10	3	10.000		
12.00	12.00	73	12.0	28.0	0.10	3	12.000		
14.00	14.00	75	14.0	30.0	0.15	3	14.000		
16.00	16.00	82	16.0	34.0	0.15	3	16.000		
18.00	18.00	84	18.0	36.0	0.15	3	18.000		
20.00	20.00	92	20.0	42.0	0.15	3	20.000		

ISO	Hardness	vc	fz (mm/z) / Ø							vc	fz (mm/z) / Ø							
			3	6	8	10	12	16	20		3	6	8	10	12	16	20	
P	≤ 850 N/mm ²	120	0,012	0,024	0,032	0,042	0,05	0,07	0,08		140	0,014	0,028	0,037	0,048	0,06	0,08	0,10
	≥ 850 N/mm ²	90	0,011	0,021	0,028	0,039	0,05	0,06	0,08			110	0,012	0,024	0,032	0,045	0,05	0,07
M	≤ 750 N/mm ²	80	0,008	0,017	0,022	0,030	0,04	0,05	0,06		100	0,010	0,019	0,026	0,035	0,04	0,06	0,07
	≥ 750 N/mm ²	50	0,006	0,013	0,017	0,024	0,03	0,04	0,05			70	0,008	0,015	0,020	0,029	0,03	0,05
K	≤ 240 HB	110	0,011	0,022	0,030	0,039	0,05	0,06	0,08		130	0,013	0,026	0,034	0,045	0,05	0,07	0,09
N	≥ 7% Si	160	0,016	0,031	0,042	0,056	0,07	0,09	0,11		190	0,018	0,036	0,048	0,064	0,08	0,10	0,13

Please reduce cutting values for bright finish tools: vc -50% and fz -25%

Solid carbide universal milling cutters

Slot drills (3-fluted)



Tool material	Solid carbide	
Surface	○	●
Type	N	N
Shank form	HB	HB

P • **GUHRING NAVIGATOR**
M • Cutting data page 335
K •
N •
S •
H • centre cutting

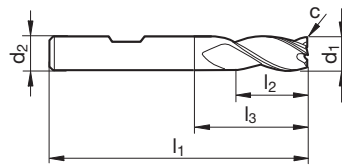

Article no. **3296** **3719**

d1 h10	d2 h6	l1	l2	l3	c	Z	Code no.
mm	mm	mm	mm	mm	mm x 45°		
2.00	6.00	50	3.0	7.4	0.02	3	2.000
2.50	6.00	50	3.0	7.4	0.05	3	2.500
3.00	6.00	50	4.0	8.4	0.05	3	3.000
3.50	6.00	50	4.0	8.4	0.05	3	3.500
4.00	6.00	54	5.0	10.4	0.05	3	4.000
5.00	6.00	54	6.0	12.4	0.05	3	5.000
5.50	6.00	54	7.0	14.9	0.05	3	5.500
6.00	6.00	54	7.0	18.0	0.05	3	6.000
7.00	8.00	58	8.0	16.9	0.10	3	7.000
8.00	8.00	58	9.0	22.0	0.10	3	8.000
8.50	10.00	66	10.0	20.9	0.10	3	8.500
9.00	10.00	66	10.0	20.9	0.10	3	9.000
10.00	10.00	66	11.0	26.0	0.10	3	10.000
12.00	12.00	73	12.0	28.0	0.10	3	12.000
14.00	14.00	75	14.0	30.0	0.15	3	14.000
16.00	16.00	82	16.0	34.0	0.15	3	16.000
18.00	18.00	84	18.0	36.0	0.15	3	18.000
20.00	20.00	92	20.0	42.0	0.15	3	20.000

ISO	Hardness	vc	fz (mm/z) / Ø							vc	fz (mm/z) / Ø							
			3	6	8	10	12	16	20		3	6	8	10	12	16	20	
P	≤ 850 N/mm ²	120	0,012	0,024	0,032	0,042	0,05	0,07	0,08		140	0,014	0,028	0,037	0,048	0,06	0,08	0,10
	≥ 850 N/mm ²	90	0,011	0,021	0,028	0,039	0,05	0,06	0,08			110	0,012	0,024	0,032	0,045	0,05	0,07
M	≤ 750 N/mm ²	80	0,008	0,017	0,022	0,030	0,04	0,05	0,06		100	0,010	0,019	0,026	0,035	0,04	0,06	0,07
	≥ 750 N/mm ²	50	0,006	0,013	0,017	0,024	0,03	0,04	0,05			70	0,008	0,015	0,020	0,029	0,03	0,05
K	≤ 240 HB	110	0,011	0,022	0,030	0,039	0,05	0,06	0,08	130	0,013	0,026	0,034	0,045	0,05	0,07	0,09	
N	≥ 7% Si	160	0,016	0,031	0,042	0,056	0,07	0,09	0,11	190	0,018	0,036	0,048	0,064	0,08	0,10	0,13	

Please reduce cutting values for bright finish tools: vc -50% and fz -25%



Slot drills (3-fluted)



Tool material	Solid carbide	
Surface	○	⦿
Type	N	N
Shank form	HA	HA

P • **GUHRING NAVIGATOR**
M • Cutting data page 335
K •
N •
S •
H • centre cutting

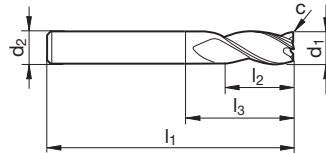

Article no. **3559** **3560**

d1 h10	d2 h6	l1	l2	l3	c	Z	Code no.
mm	mm	mm	mm	mm	mm x 45°		
2.00	6.00	57	6.0	10.4	0.02	3	2.000
2.50	6.00	57	7.0	11.4	0.05	3	2.500
2.80	6.00	57	7.0	11.4	0.05	3	2.800
3.00	6.00	57	7.0	11.4	0.05	3	3.000
3.50	6.00	57	7.0	11.4	0.05	3	3.500
3.80	6.00	57	8.0	13.9	0.05	3	3.800
4.00	6.00	57	8.0	13.9	0.05	3	4.000
4.50	6.00	57	8.0	13.9	0.05	3	4.500
4.80	6.00	57	10.0	16.9	0.05	3	4.800
5.00	6.00	57	10.0	16.9	0.05	3	5.000
5.80	6.00	57	10.0	17.9	0.05	3	5.800
6.00	6.00	57	10.0	21.0	0.05	3	6.000
6.80	8.00	63	13.0	21.9	0.10	3	6.800
7.00	8.00	63	13.0	21.9	0.10	3	7.000
7.80	8.00	63	16.0	25.9	0.10	3	7.800
8.00	8.00	63	16.0	27.0	0.10	3	8.000
8.50	10.00	72	16.0	27.4	0.10	3	8.500
8.70	10.00	72	16.0	27.4	0.10	3	8.700
9.00	10.00	72	16.0	27.4	0.10	3	9.000
9.70	10.00	72	19.0	31.4	0.10	3	9.700
10.00	10.00	72	19.0	32.0	0.10	3	10.000
11.70	12.00	83	22.0	36.4	0.10	3	11.700
12.00	12.00	83	22.0	38.0	0.10	3	12.000
13.70	14.00	83	22.0	37.4	0.15	3	13.700
14.00	14.00	83	22.0	38.0	0.15	3	14.000
14.00	16.00	92	26.0	37.4	0.15	3	14.001
15.70	16.00	92	26.0	44.0	0.15	3	15.700
16.00	16.00	92	26.0	44.0	0.15	3	16.000
18.00	18.00	92	26.0	44.0	0.15	3	18.000
18.00	20.00	104	32.0	45.0	0.15	3	18.001
20.00	20.00	104	32.0	54.0	0.15	3	20.000

Solid carbide universal milling cutters

ISO	Hardness	vc	fz (mm/z) / Ø							vc	fz (mm/z) / Ø							
			3	6	8	10	12	16	20		3	6	8	10	12	16	20	
P	≤ 850 N/mm ²	120	0,012	0,024	0,032	0,042	0,05	0,07	0,08		140	0,014	0,028	0,037	0,048	0,06	0,08	0,10
	≥ 850 N/mm ²	90	0,011	0,021	0,028	0,039	0,05	0,06	0,08		110	0,012	0,024	0,032	0,045	0,05	0,07	0,09
M	≤ 750 N/mm ²	80	0,008	0,017	0,022	0,030	0,04	0,05	0,06		100	0,010	0,019	0,026	0,035	0,04	0,06	0,07
	≥ 750 N/mm ²	50	0,006	0,013	0,017	0,024	0,03	0,04	0,05		70	0,008	0,015	0,020	0,029	0,03	0,05	0,06
K	≤ 240 HB	110	0,011	0,022	0,030	0,039	0,05	0,06	0,08		130	0,013	0,026	0,034	0,045	0,05	0,07	0,09
N	≥ 7% Si	160	0,016	0,031	0,042	0,056	0,07	0,09	0,11		190	0,018	0,036	0,048	0,064	0,08	0,10	0,13

Please reduce cutting values for bright finish tools: vc -50% and fz -25%

Slot drills (3-fluted)



Tool material	Solid carbide	
Surface	○	●
Type	N	N
Shank form	HB	HB

P • **GUHRING NAVIGATOR**
M • Cutting data page 335
K •
N •
S •
H • centre cutting

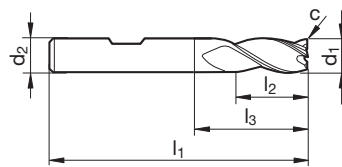

Article no. **3297** **3720**

d1 h10	d2 h6	l1	l2	l3	c	Z	Code no.
mm	mm	mm	mm	mm	mm x 45°		
2.00	6.00	57	6.0	10.4	0.02	3	2.000
2.50	6.00	57	7.0	11.4	0.05	3	2.500
3.00	6.00	57	7.0	11.4	0.05	3	3.000
3.50	6.00	57	7.0	11.4	0.05	3	3.500
4.00	6.00	57	8.0	13.9	0.05	3	4.000
4.50	6.00	57	8.0	13.9	0.05	3	4.500
5.00	6.00	57	10.0	16.9	0.05	3	5.000
6.00	6.00	57	10.0	21.0	0.05	3	6.000
7.00	8.00	63	13.0	21.9	0.10	3	7.000
8.00	8.00	63	16.0	27.0	0.10	3	8.000
8.50	10.00	72	16.0	27.4	0.10	3	8.500
9.00	10.00	72	16.0	27.4	0.10	3	9.000
10.00	10.00	72	19.0	32.0	0.10	3	10.000
12.00	12.00	83	22.0	38.0	0.10	3	12.000
14.00	14.00	83	22.0	38.0	0.15	3	14.000
16.00	16.00	92	26.0	44.0	0.15	3	16.000
18.00	18.00	92	26.0	44.0	0.15	3	18.000
20.00	20.00	104	32.0	54.0	0.15	3	20.000

ISO	Hardness	vc	fz (mm/z) / Ø							vc	fz (mm/z) / Ø							
			3	6	8	10	12	16	20		3	6	8	10	12	16	20	
P	≤ 850 N/mm ²	120	0,012	0,024	0,032	0,042	0,05	0,07	0,08		140	0,014	0,028	0,037	0,048	0,06	0,08	0,10
	≥ 850 N/mm ²	90	0,011	0,021	0,028	0,039	0,05	0,06	0,08			110	0,012	0,024	0,032	0,045	0,05	0,07
M	≤ 750 N/mm ²	80	0,008	0,017	0,022	0,030	0,04	0,05	0,06		100	0,010	0,019	0,026	0,035	0,04	0,06	0,07
	≥ 750 N/mm ²	50	0,006	0,013	0,017	0,024	0,03	0,04	0,05			70	0,008	0,015	0,020	0,029	0,03	0,05
K	≤ 240 HB	110	0,011	0,022	0,030	0,039	0,05	0,06	0,08	130	0,013	0,026	0,034	0,045	0,05	0,07	0,09	
N	≥ 7% Si	160	0,016	0,031	0,042	0,056	0,07	0,09	0,11	190	0,018	0,036	0,048	0,064	0,08	0,10	0,13	

Please reduce cutting values for bright finish tools: vc -50% and fz -25%

Solid carbide universal milling cutters



Slot drills (3-fluted)



Tool material	Solid carbide	
Surface	○	● F
Type	N	N
Shank form	HA	HA

P ● **GUHRING NAVIGATOR**
M ● Cutting data page 335
K ●
N ●
S ●
H ● centre cutting

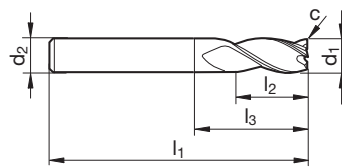

Article no. **3307** **3677**

d1 h10	d2 h6	l1	l2	l3	c	Z	Code no.
mm	mm	mm	mm	mm	mm x 45°		
2.00	2.00	32	5.0	9.0	0.02	3	2.000
2.50	2.50	32	6.0	10.0	0.05	3	2.500
3.00	3.00	38	7.0	10.0	0.05	3	3.000
3.50	3.50	50	7.0	22.0	0.05	3	3.500
4.00	4.00	50	8.0	22.0	0.05	3	4.000
4.50	4.50	50	8.0	22.0	0.05	3	4.500
5.00	5.00	50	10.0	22.0	0.05	3	5.000
5.50	5.50	57	10.0	21.0	0.05	3	5.500
6.00	6.00	57	10.0	21.0	0.05	3	6.000
6.50	6.50	60	13.0	24.0	0.10	3	6.500
7.00	7.00	60	13.0	24.0	0.10	3	7.000
7.50	7.50	63	16.0	27.0	0.10	3	7.500
8.00	8.00	63	16.0	27.0	0.10	3	8.000
8.50	8.50	67	16.0	27.0	0.10	3	8.500
9.00	9.00	67	16.0	27.0	0.10	3	9.000
9.50	9.50	72	19.0	32.0	0.10	3	9.500
10.00	10.00	72	19.0	32.0	0.10	3	10.000
11.00	11.00	83	22.0	38.0	0.10	3	11.000
12.00	12.00	83	22.0	38.0	0.10	3	12.000
13.00	13.00	83	22.0	38.0	0.15	3	13.000
14.00	14.00	83	22.0	38.0	0.15	3	14.000
15.00	15.00	92	26.0	44.0	0.15	3	15.000
16.00	16.00	92	26.0	44.0	0.15	3	16.000
18.00	18.00	92	26.0	44.0	0.15	3	18.000
20.00	20.00	104	32.0	54.0	0.15	3	20.000

Solid carbide universal milling cutters

ISO	Hardness	vc	fz (mm/z) / Ø							vc	fz (mm/z) / Ø								
			3	6	8	10	12	16	20		3	6	8	10	12	16	20		
			ap = 1,0 x D								ae = 1,0 x D			ap = 1,0 x D					
P	≤ 850 N/mm ²	120	0,012	0,024	0,032	0,042	0,05	0,07	0,08	140	0,014	0,028	0,037	0,048	0,06	0,08	0,10		
	≥ 850 N/mm ²	90	0,011	0,021	0,028	0,039	0,05	0,06	0,08	110	0,012	0,024	0,032	0,045	0,05	0,07	0,09		
M	≤ 750 N/mm ²	80	0,008	0,017	0,022	0,030	0,04	0,05	0,06	100	0,010	0,019	0,026	0,035	0,04	0,06	0,07		
	≥ 750 N/mm ²	50	0,006	0,013	0,017	0,024	0,03	0,04	0,05	70	0,008	0,015	0,020	0,029	0,03	0,05	0,06		
K	≤ 240 HB	110	0,011	0,022	0,030	0,039	0,05	0,06	0,08	130	0,013	0,026	0,034	0,045	0,05	0,07	0,09		
N	≥ 7% Si	160	0,016	0,031	0,042	0,056	0,07	0,09	0,11	190	0,018	0,036	0,048	0,064	0,08	0,10	0,13		

Please reduce cutting values for bright finish tools: vc -50% and fz -25%

Slot drills (3-fluted)



Tool material	Solid carbide	
Surface	○	● (F)
Type	N	N
Shank form	HA	HA

P • **GUHRING NAVIGATOR**
M • Cutting data page 335
K •
N •
S •
H • centre cutting

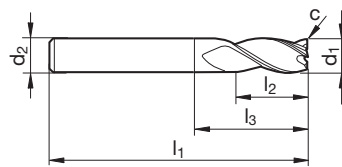

Article no. **3220** **3711**

d1 h10	d2 h6	l1	l2	l3	c	Z	Code no.
mm	mm	mm	mm	mm	mm x 45°		
2.00	2.00	32	8.0	12.0	0.02	3	2.000
2.50	2.50	32	8.0	12.0	0.05	3	2.500
3.00	3.00	32	12.0	16.0	0.05	3	3.000
3.50	3.50	32	12.0	16.0	0.05	3	3.500
4.00	4.00	40	12.0	16.0	0.05	3	4.000
4.50	4.50	50	14.0	19.0	0.05	3	4.500
5.00	5.00	50	14.0	19.0	0.05	3	5.000
5.50	5.50	50	16.0	22.0	0.05	3	5.500
6.00	6.00	50	16.0	22.0	0.05	3	6.000
6.50	6.50	60	16.0	23.0	0.10	3	6.500
7.00	7.00	60	20.0	27.0	0.10	3	7.000
7.50	7.50	60	20.0	28.0	0.10	3	7.500
8.00	8.00	60	20.0	28.0	0.10	3	8.000
8.50	8.50	60	20.0	29.0	0.10	3	8.500
9.00	9.00	60	20.0	29.0	0.10	3	9.000
9.50	9.50	70	22.0	32.0	0.10	3	9.500
10.00	10.00	70	22.0	32.0	0.10	3	10.000
11.00	11.00	70	22.0	33.0	0.10	3	11.000
12.00	12.00	70	22.0	34.0	0.10	3	12.000
13.00	13.00	75	25.0	37.0	0.15	3	13.000
14.00	14.00	75	25.0	38.0	0.15	3	14.000
15.00	15.00	75	25.0	39.0	0.15	3	15.000
16.00	16.00	75	25.0	40.0	0.15	3	16.000
18.00	18.00	100	35.0	51.0	0.15	3	18.000
20.00	20.00	100	35.0	54.0	0.15	3	20.000

Solid carbide universal milling cutters

ISO	Hardness	vc	fz (mm/z) / Ø							vc	fz (mm/z) / Ø						
			3	6	8	10	12	16	20		3	6	8	10	12	16	20
			ap = 1,0 x D								ae = 1,0 x D			ap = 1,0 x D			
P	≤ 850 N/mm ²	120	0,012	0,024	0,032	0,042	0,05	0,07	0,08	140	0,014	0,028	0,037	0,048	0,06	0,08	0,10
	≥ 850 N/mm ²	90	0,011	0,021	0,028	0,039	0,05	0,06	0,08	110	0,012	0,024	0,032	0,045	0,05	0,07	0,09
M	≤ 750 N/mm ²	80	0,008	0,017	0,022	0,030	0,04	0,05	0,06	100	0,010	0,019	0,026	0,035	0,04	0,06	0,07
	≥ 750 N/mm ²	50	0,006	0,013	0,017	0,024	0,03	0,04	0,05	70	0,008	0,015	0,020	0,029	0,03	0,05	0,06
K	≤ 240 HB	110	0,011	0,022	0,030	0,039	0,05	0,06	0,08	130	0,013	0,026	0,034	0,045	0,05	0,07	0,09
N	≥ 7% Si	160	0,016	0,031	0,042	0,056	0,07	0,09	0,11	190	0,018	0,036	0,048	0,064	0,08	0,10	0,13

Please reduce cutting values for bright finish tools: vc -50% and fz -25%



Slot drills XL (3-fluted)



Tool material	Solid carbide	
Surface	○	●
Type	N	N
Shank form	HA	HA

P • **GUHRING NAVIGATOR**
M • Cutting data page 335
K •
N •
S •
H • centre cutting

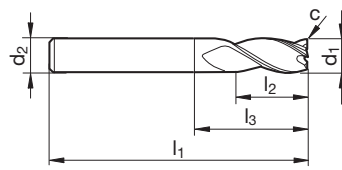

Article no. **3314** **3680**

d1 h10	d2 h6	l1	l2	l3	c	Z	Code no.
mm	mm	mm	mm	mm	mm x 45°		
3.00	3.00	75	20.0	47.0	0.05	3	3.000
4.00	4.00	75	25.0	47.0	0.05	3	4.000
5.00	5.00	75	30.0	47.0	0.05	3	5.000
6.00	6.00	75	30.0	39.0	0.05	3	6.000
8.00	8.00	100	40.0	64.0	0.10	3	8.000
10.00	10.00	100	40.0	60.0	0.10	3	10.000
12.00	12.00	150	45.0	105.0	0.10	3	12.000
16.00	16.00	150	65.0	102.0	0.15	3	16.000
20.00	20.00	150	65.0	100.0	0.15	3	20.000

ISO	Hardness	vc	fz (mm/z) / Ø							vc	fz (mm/z) / Ø						
			3	6	8	10	12	16	20		3	6	8	10	12	16	20
P	≤ 850 N/mm ²	40	0,004	0,007	0,010	0,013	0,015	0,020	0,025	50	0,004	0,008	0,011	0,014	0,017	0,023	0,029
	≥ 850 N/mm ²	30	0,003	0,006	0,008	0,012	0,014	0,019	0,023	40	0,004	0,007	0,010	0,013	0,016	0,022	0,027
M	≤ 750 N/mm ²	30	0,003	0,005	0,007	0,009	0,011	0,014	0,018	35	0,003	0,006	0,008	0,010	0,012	0,017	0,021
	≥ 750 N/mm ²	20	0,002	0,004	0,005	0,007	0,009	0,012	0,014	25	0,002	0,005	0,006	0,009	0,010	0,014	0,017
K	≤ 240 HB	40	0,003	0,007	0,009	0,012	0,014	0,019	0,023	45	0,004	0,008	0,010	0,013	0,016	0,022	0,027
N	≥ 7% Si	55	0,005	0,009	0,012	0,017	0,020	0,027	0,034	65	0,005	0,011	0,014	0,019	0,023	0,031	0,039

Please reduce cutting values for bright finish tools: vc -50% and fz -25%

Solid carbide universal milling cutters

Mini slot drills (3-fluted)



- P** • **GUHRING NAVIGATOR**
- M** • Cutting data page 335
- K** ○
- N** •
- S** •
- H** • centre cutting

Tool material	Solid carbide
Surface	F
Type	N
Shank form	HA/HB

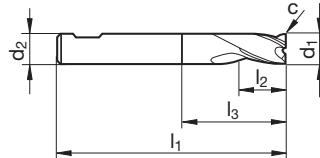

Article no. **3684**

d1 e8	d2 h6	l1	l2	l3	c	Z	Code no.
mm	mm	mm	mm	mm	mm x 45°		
0.30	3.00	38	1.0	3.4		3	0.300
0.40	3.00	38	1.0	3.4		3	0.400
0.50	3.00	38	1.5	3.4	0.02	3	0.500
0.60	3.00	38	1.5	3.4	0.02	3	0.600
0.80	3.00	38	2.0	3.9	0.02	3	0.800
1.00	3.00	38	2.0	3.9	0.02	3	1.000
1.20	3.00	38	2.0	3.9	0.02	3	1.200
1.50	3.00	38	2.0	3.9	0.02	3	1.500
1.80	3.00	38	2.0	3.9	0.02	3	1.800
2.00	6.00	38	4.0	7.4	0.02	3	2.000
2.50	6.00	38	5.0	8.4	0.05	3	2.500
3.00	6.00	38	5.0	8.4	0.05	3	3.000
3.50	6.00	38	6.0	9.4	0.05	3	3.500
4.00	6.00	38	7.0	10.4	0.05	3	4.000
4.50	6.00	38	8.0	12.4	0.05	3	4.500
5.00	6.00	38	8.0	12.4	0.05	3	5.000
5.50	6.00	38	8.0	12.4	0.05	3	5.500
5.75	6.00	38	8.0	12.4	0.05	3	5.750
6.00	6.00	38	8.0	14.0	0.05	3	6.000
6.75	8.00	42	10.0	15.4	0.10	3	6.750
7.00	8.00	42	10.0	16.4	0.10	3	7.000
7.75	8.00	42	10.0	16.4	0.10	3	7.750
8.00	8.00	43	11.0	19.0	0.10	3	8.000
8.70	10.00	48	11.0	17.4	0.10	3	8.700
9.00	10.00	48	11.0	17.4	0.10	3	9.000
9.70	10.00	48	11.0	17.4	0.10	3	9.700
10.00	10.00	50	13.0	23.0	0.10	3	10.000
12.00	12.00	55	15.0	24.5	0.10	3	12.000
14.00	14.00	58	15.0	27.5	0.15	3	14.000
16.00	16.00	62	18.0	29.0	0.15	3	16.000
18.00	18.00	70	20.0	37.0	0.15	3	18.000
20.00	20.00	75	22.0	41.0	0.15	3	20.000

Solid carbide universal milling cutters

ISO	Hardness	vc	fz (mm/z) / Ø							vc	fz (mm/z) / Ø							
			3	6	8	10	12	16	20		3	6	8	10	12	16	20	
P	≤ 850 N/mm ²	120	0,012	0,024	0,032	0,042	0,05	0,07	0,08		140	0,014	0,028	0,037	0,048	0,06	0,08	0,10
	≥ 850 N/mm ²	90	0,011	0,021	0,028	0,039	0,05	0,06	0,08			110	0,012	0,024	0,032	0,045	0,05	0,07
M	≤ 750 N/mm ²	80	0,008	0,017	0,022	0,030	0,04	0,05	0,06		100	0,010	0,019	0,026	0,035	0,04	0,06	0,07
	≥ 750 N/mm ²	50	0,006	0,013	0,017	0,024	0,03	0,04	0,05			70	0,008	0,015	0,020	0,029	0,03	0,05
K	≤ 240 HB	110	0,011	0,022	0,030	0,039	0,05	0,06	0,08		130	0,013	0,026	0,034	0,045	0,05	0,07	0,09
N	≥ 7% Si	160	0,016	0,031	0,042	0,056	0,07	0,09	0,11		190	0,018	0,036	0,048	0,064	0,08	0,10	0,13



Mini slot drills (3-fluted)



Tool material	Solid carbide
Surface	F
Type	NH
Shank form	HA/HB

P • **GUHRING NAVIGATOR**
M • Cutting data page 335
K ○
N •
S ○
H □ • centre cutting

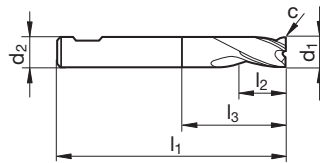

Article no. **3686**

d1 e8	d2 h6	l1	l2	l3	c	Z	Code no.
mm	mm	mm	mm	mm	mm x 45°		
1.00	3.00	38	2.0	3.4	0.02	3	1.000
1.20	3.00	38	2.0	3.4	0.02	3	1.200
1.50	3.00	38	3.0	5.9	0.02	3	1.500
1.80	3.00	38	3.0	5.9	0.02	3	1.800
2.00	6.00	45	4.0	6.9	0.02	3	2.000
2.50	6.00	45	5.0	7.9	0.05	3	2.500
3.00	6.00	45	6.0	9.9	0.05	3	3.000
3.50	6.00	45	6.0	9.9	0.05	3	3.500
4.00	6.00	45	7.0	10.9	0.05	3	4.000
4.50	6.00	45	8.0	13.4	0.05	3	4.500
5.00	6.00	45	8.0	13.4	0.05	3	5.000
5.50	6.00	45	8.0	14.4	0.05	3	5.500
5.75	6.00	45	10.0	17.0	0.05	3	5.750
6.00	6.00	45	10.0	15.0	0.05	3	6.000
6.75	8.00	55	10.0	18.4	0.10	3	6.750
7.00	8.00	55	12.0	18.9	0.10	3	7.000
7.75	8.00	55	12.0	18.9	0.10	3	7.750
8.00	8.00	55	13.0	18.9	0.10	3	8.000
8.70	10.00	55	14.0	23.4	0.10	3	8.700
9.00	10.00	55	14.0	23.4	0.10	3	9.000
9.70	10.00	55	16.0	25.0	0.10	3	9.700
10.00	10.00	55	16.0	25.0	0.10	3	10.000

Solid carbide universal milling cutters

ISO	Hardness	vc	fz (mm/z) / Ø						vc	fz (mm/z) / Ø							
			3	6	8	10	12	16		20	3	6	8	10	12	16	20
P	≤ 850 N/mm ²	120	0,012	0,024	0,032	0,042	0,05	0,07	0,08	140	0,014	0,028	0,037	0,048	0,06	0,08	0,10
	≥ 850 N/mm ²	90	0,011	0,021	0,028	0,039	0,05	0,06	0,08	110	0,012	0,024	0,032	0,045	0,05	0,07	0,09
M	≤ 750 N/mm ²	80	0,008	0,017	0,022	0,030	0,04	0,05	0,06	100	0,010	0,019	0,026	0,035	0,04	0,06	0,07
	≥ 750 N/mm ²	50	0,006	0,013	0,017	0,024	0,03	0,04	0,05	70	0,008	0,015	0,020	0,029	0,03	0,05	0,06
K	≤ 240 HB	110	0,011	0,022	0,030	0,039	0,05	0,06	0,08	130	0,013	0,026	0,034	0,045	0,05	0,07	0,09
N	≥ 7% Si	160	0,016	0,031	0,042	0,056	0,07	0,09	0,11	190	0,018	0,036	0,048	0,064	0,08	0,10	0,13

End mills (4-fluted)



Tool material	Solid carbide	
Surface	○	⦿
Type	N	N
Shank form	HA	HA

P • **GUHRING NAVIGATOR**
M • Cutting data page 335
K •
N •
S •
H • centre cutting

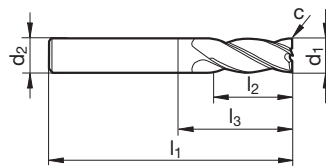

Article no. **3198** **3637**

d1 h10	d2 h6	l1	l2	l3	c	Z	Code no.
mm	mm	mm	mm	mm	mm x 45°		
2.00	6.00	50	4.0	8.4	0.02	4	2.000
3.00	6.00	50	5.0	9.4	0.05	4	3.000
4.00	6.00	54	8.0	13.4	0.05	4	4.000
5.00	6.00	54	9.0	15.9	0.05	4	5.000
6.00	6.00	54	10.0	18.0	0.05	4	6.000
8.00	8.00	58	12.0	22.0	0.10	4	8.000
10.00	10.00	66	14.0	26.0	0.10	4	10.000
12.00	12.00	73	16.0	28.0	0.10	4	12.000
14.00	14.00	75	18.0	30.0	0.15	4	14.000
16.00	16.00	82	22.0	34.0	0.15	4	16.000
18.00	18.00	84	24.0	36.0	0.15	4	18.000
20.00	20.00	92	26.0	42.0	0.15	4	20.000

ISO	Hardness	vc	fz (mm/z) / Ø								vc	fz (mm/z) / Ø							
			3	6	8	10	12	16	20	3		6	8	10	12	16	20		
			ap = 1,0 x D				ae = 1,0 x D					ap = 1,0 x D				ae max = 0,75 x D			
P	≤ 850 N/mm ²	120	0,012	0,024	0,032	0,042	0,05	0,07	0,08	140	0,014	0,028	0,037	0,048	0,06	0,08	0,10		
	≥ 850 N/mm ²	90	0,011	0,021	0,028	0,039	0,05	0,06	0,08	110	0,012	0,024	0,032	0,045	0,05	0,07	0,09		
M	≤ 750 N/mm ²	80	0,008	0,017	0,022	0,030	0,04	0,05	0,06	100	0,010	0,019	0,026	0,035	0,04	0,06	0,07		
	≥ 750 N/mm ²	50	0,006	0,013	0,017	0,024	0,03	0,04	0,05	70	0,008	0,015	0,020	0,029	0,03	0,05	0,06		
K	≤ 240 HB	110	0,011	0,022	0,030	0,039	0,05	0,06	0,08	130	0,013	0,026	0,034	0,045	0,05	0,07	0,09		
N	≥ 7% Si	160	0,016	0,031	0,042	0,056	0,07	0,09	0,11	190	0,018	0,036	0,048	0,064	0,08	0,10	0,13		

Please reduce cutting values for bright finish tools: vc -50% and fz -25%

Solid carbide universal milling cutters



End mills (4-fluted)



Tool material	Solid carbide	
Surface	○	⊕
Type	N	N
Shank form	HB	HB

P • **GUHRING NAVIGATOR**
M • Cutting data page 335
K •
N •
S •
H • centre cutting

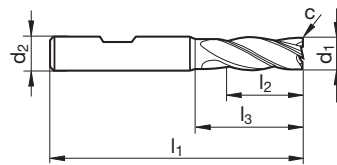

Article no. **3298** **3721**

d1 h10	d2 h6	l1	l2	l3	c	Z	Code no.
mm	mm	mm	mm	mm	mm x 45°		
2.00	6.00	50	4.0	8.4	0.02	4	2.000
3.00	6.00	50	5.0	9.4	0.05	4	3.000
4.00	6.00	54	8.0	13.4	0.05	4	4.000
5.00	6.00	54	9.0	15.9	0.05	4	5.000
6.00	6.00	54	10.0	18.0	0.05	4	6.000
8.00	8.00	58	12.0	22.0	0.10	4	8.000
10.00	10.00	66	14.0	26.0	0.10	4	10.000
12.00	12.00	73	16.0	28.0	0.10	4	12.000
14.00	14.00	75	18.0	30.0	0.15	4	14.000
16.00	16.00	82	22.0	34.0	0.15	4	16.000
18.00	18.00	84	24.0	36.0	0.15	4	18.000
20.00	20.00	92	26.0	42.0	0.15	4	20.000

ISO	Hardness	vc	fz (mm/z) / Ø								vc	fz (mm/z) / Ø							
			ap = 1,0 x D				ap = 1,0 x D					ap = 1,0 x D				ap max = 0,75 x D			
			3	6	8	10	12	16	20	3		6	8	10	12	16	20		
P	≤ 850 N/mm ²	120	0,012	0,024	0,032	0,042	0,05	0,07	0,08	140	0,014	0,028	0,037	0,048	0,06	0,08	0,10		
	≥ 850 N/mm ²	90	0,011	0,021	0,028	0,039	0,05	0,06	0,08	110	0,012	0,024	0,032	0,045	0,05	0,07	0,09		
M	≤ 750 N/mm ²	80	0,008	0,017	0,022	0,030	0,04	0,05	0,06	100	0,010	0,019	0,026	0,035	0,04	0,06	0,07		
	≥ 750 N/mm ²	50	0,006	0,013	0,017	0,024	0,03	0,04	0,05	70	0,008	0,015	0,020	0,029	0,03	0,05	0,06		
K	≤ 240 HB	110	0,011	0,022	0,030	0,039	0,05	0,06	0,08	130	0,013	0,026	0,034	0,045	0,05	0,07	0,09		
N	≥ 7% Si	160	0,016	0,031	0,042	0,056	0,07	0,09	0,11	190	0,018	0,036	0,048	0,064	0,08	0,10	0,13		

Please reduce cutting values for bright finish tools: vc -50% and fz -25%

Solid carbide universal milling cutters

End mills (4-fluted)



Tool material	Solid carbide	
Surface	○	●
Type	N	N
Shank form	HA	HA

P • **GUHRING NAVIGATOR**
M • Cutting data page 335
K •
N •
S •
H • centre cutting

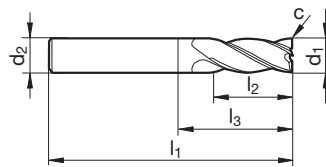

Article no. 3197 3649

d1 h10	d2 h6	l1	l2	l3	c	Z	Code no.
mm	mm	mm	mm	mm	mm x 45°		
2.00	6.00	57	7.0	11.4	0.02	4	2.000
3.00	6.00	57	8.0	12.9	0.05	4	3.000
3.50	6.00	57	10.0	15.9	0.05	4	3.500
4.00	6.00	57	11.0	16.9	0.05	4	4.000
4.50	6.00	57	11.0	16.9	0.05	4	4.500
5.00	6.00	57	13.0	19.9	0.05	4	5.000
6.00	6.00	57	13.0	21.0	0.05	4	6.000
7.00	8.00	63	16.0	23.9	0.10	4	7.000
8.00	8.00	63	19.0	27.0	0.10	4	8.000
9.00	10.00	72	19.0	28.4	0.10	4	9.000
10.00	10.00	72	22.0	32.0	0.10	4	10.000
12.00	12.00	83	26.0	38.0	0.10	4	12.000
14.00	14.00	83	26.0	38.0	0.15	4	14.000
14.00	16.00	92	32.0	38.4	0.15	4	14.001
16.00	16.00	92	32.0	44.0	0.15	4	16.000
18.00	18.00	92	32.0	44.0	0.15	4	18.000
18.00	20.00	104	38.0	48.0	0.15	4	18.001
20.00	20.00	104	38.0	54.0	0.15	4	20.000

ISO	Hardness	vc	fz (mm/z) / Ø							vc	fz (mm/z) / Ø							
			3	6	8	10	12	16	20		3	6	8	10	12	16	20	
P	≤ 850 N/mm ²	120	0,012	0,024	0,032	0,042	0,05	0,07	0,08		140	0,014	0,028	0,037	0,048	0,06	0,08	0,10
	≥ 850 N/mm ²	90	0,011	0,021	0,028	0,039	0,05	0,06	0,08		110	0,012	0,024	0,032	0,045	0,05	0,07	0,09
M	≤ 750 N/mm ²	80	0,008	0,017	0,022	0,030	0,04	0,05	0,06		100	0,010	0,019	0,026	0,035	0,04	0,06	0,07
	≥ 750 N/mm ²	50	0,006	0,013	0,017	0,024	0,03	0,04	0,05		70	0,008	0,015	0,020	0,029	0,03	0,05	0,06
K	≤ 240 HB	110	0,011	0,022	0,030	0,039	0,05	0,06	0,08	130	0,013	0,026	0,034	0,045	0,05	0,07	0,09	
N	≥ 7% Si	160	0,016	0,031	0,042	0,056	0,07	0,09	0,11	190	0,018	0,036	0,048	0,064	0,08	0,10	0,13	

Please reduce cutting values for bright finish tools: vc -50% and fz -25%

Solid carbide universal milling cutters



End mills (4-fluted)



Tool material	Solid carbide	
Surface	○	● F
Type	N	N
Shank form	HB	HB

P • **GUHRING NAVIGATOR**
M • Cutting data page 335
K •
N •
S •
H • centre cutting

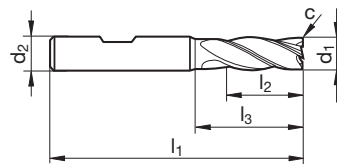

Article no. **3299** **3722**

d1 h10	d2 h6	l1	l2	l3	c	Z	Code no.
mm	mm	mm	mm	mm	mm x 45°		
2.00	6.00	57	7.0	11.4	0.02	4	2.000
3.00	6.00	57	8.0	12.9	0.05	4	3.000
3.50	6.00	57	10.0	15.9	0.05	4	3.500
4.00	6.00	57	11.0	16.9	0.05	4	4.000
4.50	6.00	57	11.0	16.9	0.05	4	4.500
5.00	6.00	57	13.0	19.9	0.05	4	5.000
6.00	6.00	57	13.0	21.0	0.05	4	6.000
7.00	8.00	63	16.0	23.9	0.10	4	7.000
8.00	8.00	63	19.0	27.0	0.10	4	8.000
9.00	10.00	72	19.0	28.4	0.10	4	9.000
10.00	10.00	72	22.0	32.0	0.10	4	10.000
12.00	12.00	83	26.0	38.0	0.10	4	12.000
14.00	14.00	83	26.0	38.0	0.15	4	14.000
16.00	16.00	92	32.0	44.0	0.15	4	16.000
18.00	18.00	92	32.0	44.0	0.15	4	18.000
20.00	20.00	104	38.0	54.0	0.15	4	20.000

ISO	Hardness	vc	fz (mm/z) / Ø							vc	fz (mm/z) / Ø							
			3	6	8	10	12	16	20		3	6	8	10	12	16	20	
P	≤ 850 N/mm ²	120	0,012	0,024	0,032	0,042	0,05	0,07	0,08		140	0,014	0,028	0,037	0,048	0,06	0,08	0,10
	≥ 850 N/mm ²	90	0,011	0,021	0,028	0,039	0,05	0,06	0,08			110	0,012	0,024	0,032	0,045	0,05	0,07
M	≤ 750 N/mm ²	80	0,008	0,017	0,022	0,030	0,04	0,05	0,06		100	0,010	0,019	0,026	0,035	0,04	0,06	0,07
	≥ 750 N/mm ²	50	0,006	0,013	0,017	0,024	0,03	0,04	0,05			70	0,008	0,015	0,020	0,029	0,03	0,05
K	≤ 240 HB	110	0,011	0,022	0,030	0,039	0,05	0,06	0,08	130	0,013	0,026	0,034	0,045	0,05	0,07	0,09	
N	≥ 7% Si	160	0,016	0,031	0,042	0,056	0,07	0,09	0,11	190	0,018	0,036	0,048	0,064	0,08	0,10	0,13	

Please reduce cutting values for bright finish tools: vc -50% and fz -25%

Solid carbide universal milling cutters

End mills (4-fluted)



Tool material	Solid carbide	
Surface	○	●
Type	N	N
Shank form	HA	HA

P • **GUHRING NAVIGATOR**
M • Cutting data page 335
K •
N •
S •
H • centre cutting

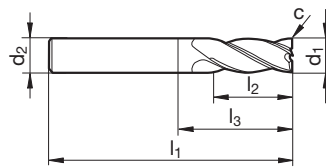

Article no. **3304** **3678**

d1 h10	d2 h6	l1	l2	l3	c	Z	Code no.
mm	mm	mm	mm	mm	mm x 45°		
2.00	2.00	32	5.0	10.0	0.02	4	2.000
2.50	2.50	32	6.0	11.0	0.05	4	2.500
3.00	3.00	38	7.0	11.0	0.05	4	3.000
3.50	3.50	50	8.0	14.0	0.05	4	3.500
4.00	4.00	50	11.0	22.0	0.05	4	4.000
4.50	4.50	50	11.0	22.0	0.05	4	4.500
5.00	5.00	50	13.0	22.0	0.05	4	5.000
6.00	6.00	57	13.0	21.0	0.05	4	6.000
7.00	7.00	60	16.0	24.0	0.10	4	7.000
7.50	7.50	63	19.0	27.0	0.10	4	7.500
8.00	8.00	63	19.0	27.0	0.10	4	8.000
9.00	9.00	67	19.0	27.0	0.10	4	9.000
10.00	10.00	72	22.0	32.0	0.10	4	10.000
11.00	11.00	83	26.0	38.0	0.10	4	11.000
12.00	12.00	83	26.0	38.0	0.10	4	12.000
13.00	13.00	83	26.0	38.0	0.15	4	13.000
14.00	14.00	83	26.0	38.0	0.15	4	14.000
15.00	15.00	92	32.0	44.0	0.15	4	15.000
16.00	16.00	92	32.0	44.0	0.15	4	16.000
18.00	18.00	92	32.0	44.0	0.15	4	18.000
20.00	20.00	104	38.0	54.0	0.15	4	20.000

Solid carbide universal milling cutters

ISO	Hardness	vc	fz (mm/z) / Ø						vc	fz (mm/z) / Ø							
			3	6	8	10	12	16		20	3	6	8	10	12	16	20
P	≤ 850 N/mm ²	120	0,012	0,024	0,032	0,042	0,05	0,07	0,08	140	0,014	0,028	0,037	0,048	0,06	0,08	0,10
	≥ 850 N/mm ²	90	0,011	0,021	0,028	0,039	0,05	0,06	0,08	110	0,012	0,024	0,032	0,045	0,05	0,07	0,09
M	≤ 750 N/mm ²	80	0,008	0,017	0,022	0,030	0,04	0,05	0,06	100	0,010	0,019	0,026	0,035	0,04	0,06	0,07
	≥ 750 N/mm ²	50	0,006	0,013	0,017	0,024	0,03	0,04	0,05	70	0,008	0,015	0,020	0,029	0,03	0,05	0,06
K	≤ 240 HB	110	0,011	0,022	0,030	0,039	0,05	0,06	0,08	130	0,013	0,026	0,034	0,045	0,05	0,07	0,09
N	≥ 7% Si	160	0,016	0,031	0,042	0,056	0,07	0,09	0,11	190	0,018	0,036	0,048	0,064	0,08	0,10	0,13

Please reduce cutting values for bright finish tools: vc -50% and fz -25%



End mills (4-fluted)



Tool material	Solid carbide	
Surface	○	● (F)
Type	N	N
Shank form	HA	HA

P • **GUHRING NAVIGATOR**
M • Cutting data page 335
K •
N •
S •
H • centre cutting

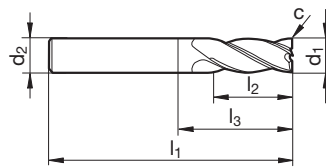

Article no. **3257** **3713**

d1 h10	d2 h6	l1	l2	l3	c	Z	Code no.
mm	mm	mm	mm	mm	mm x 45°		
4.50	4.50	50	14.0	18.0	0.05	4	4.500
5.00	5.00	50	14.0	18.0	0.05	4	5.000
5.50	5.50	50	16.0	21.0	0.05	4	5.500
6.00	6.00	50	16.0	21.0	0.05	4	6.000
6.50	6.50	60	16.0	21.0	0.10	4	6.500
7.00	7.00	60	20.0	25.0	0.10	4	7.000
7.50	7.50	60	20.0	26.0	0.10	4	7.500
8.00	8.00	60	20.0	26.0	0.10	4	8.000
8.50	8.50	60	20.0	27.0	0.10	4	8.500
9.00	9.00	60	20.0	27.0	0.10	4	9.000
9.50	9.50	70	22.0	30.0	0.10	4	9.500
10.00	10.00	70	22.0	30.0	0.10	4	10.000
11.00	11.00	70	22.0	30.0	0.10	4	11.000
12.00	12.00	70	22.0	31.0	0.10	4	12.000
13.00	13.00	75	25.0	34.0	0.15	4	13.000
14.00	14.00	75	25.0	35.0	0.15	4	14.000
15.00	15.00	75	25.0	36.0	0.15	4	15.000
16.00	16.00	75	25.0	37.0	0.15	4	16.000
18.00	18.00	100	35.0	48.0	0.15	4	18.000
20.00	20.00	100	35.0	49.0	0.15	4	20.000

Solid carbide universal milling cutters

ISO	Hardness	vc	fz (mm/z) / Ø						vc	fz (mm/z) / Ø							
			3	6	8	10	12	16		20	3	6	8	10	12	16	20
P	≤ 850 N/mm ²	120	0,012	0,024	0,032	0,042	0,05	0,07	0,08	140	0,014	0,028	0,037	0,048	0,06	0,08	0,10
	≥ 850 N/mm ²	90	0,011	0,021	0,028	0,039	0,05	0,06	0,08	110	0,012	0,024	0,032	0,045	0,05	0,07	0,09
M	≤ 750 N/mm ²	80	0,008	0,017	0,022	0,030	0,04	0,05	0,06	100	0,010	0,019	0,026	0,035	0,04	0,06	0,07
	≥ 750 N/mm ²	50	0,006	0,013	0,017	0,024	0,03	0,04	0,05	70	0,008	0,015	0,020	0,029	0,03	0,05	0,06
K	≤ 240 HB	110	0,011	0,022	0,030	0,039	0,05	0,06	0,08	130	0,013	0,026	0,034	0,045	0,05	0,07	0,09
N	≥ 7% Si	160	0,016	0,031	0,042	0,056	0,07	0,09	0,11	190	0,018	0,036	0,048	0,064	0,08	0,10	0,13

Please reduce cutting values for bright finish tools: vc -50% and fz -25%

XL slot drills (2-fluted)



Tool material	Solid carbide	
Surface	○	●
Type	N	N
Shank form	HA	HA

P • **GUHRING NAVIGATOR**
M • Cutting data page 335
K •
N •
S •
H • centre cutting

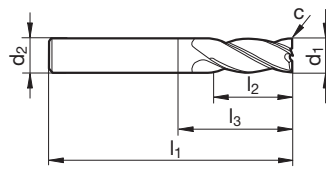

Article no. **3012** **3023**

d1 h10	d2 h6	l1	l2	l3	c	Z	Code no.
mm	mm	mm	mm	mm	mm x 45°		
3.00	3.00	75	20.0	47.0	0.05	4	3.000
4.00	4.00	75	25.0	47.0	0.05	4	4.000
5.00	5.00	75	30.0	47.0	0.05	4	5.000
6.00	6.00	75	30.0	39.0	0.05	4	6.000
8.00	8.00	100	40.0	64.0	0.10	4	8.000
10.00	10.00	100	40.0	60.0	0.10	4	10.000
12.00	12.00	150	45.0	105.0	0.10	4	12.000
14.00	14.00	150	45.0	105.0	0.15	4	14.000
14.00	16.00	150	65.0	78.0	0.15	4	14.001
16.00	16.00	150	65.0	102.0	0.15	4	16.000
18.00	18.00	150	65.0	102.0	0.15	4	18.000
18.00	20.00	150	65.0	79.0	0.15	4	18.001
20.00	20.00	150	65.0	100.0	0.15	4	20.000

Solid carbide universal milling cutters

ISO	Hardness	vc	fz (mm/z) / Ø							vc	fz (mm/z) / Ø							
			3	6	8	10	12	16	20		3	6	8	10	12	16	20	
P	≤ 850 N/mm ²	40	0,004	0,007	0,010	0,013	0,015	0,020	0,025		50	0,004	0,008	0,011	0,014	0,017	0,023	0,029
	≥ 850 N/mm ²	30	0,003	0,006	0,008	0,012	0,014	0,019	0,023		40	0,004	0,007	0,010	0,013	0,016	0,022	0,027
M	≤ 750 N/mm ²	30	0,003	0,005	0,007	0,009	0,011	0,014	0,018		35	0,003	0,006	0,008	0,010	0,012	0,017	0,021
	≥ 750 N/mm ²	20	0,002	0,004	0,005	0,007	0,009	0,012	0,014		25	0,002	0,005	0,006	0,009	0,010	0,014	0,017
K	≤ 240 HB	40	0,003	0,007	0,009	0,012	0,014	0,019	0,023		45	0,004	0,008	0,010	0,013	0,016	0,022	0,027
N	≥ 7% Si	55	0,005	0,009	0,012	0,017	0,020	0,027	0,034		65	0,005	0,011	0,014	0,019	0,023	0,031	0,039

Please reduce cutting values for bright finish tools: vc -50% and fz -25%



Ratio end mill sets RF 100 Diver

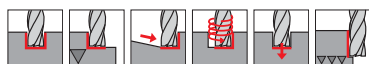

- P** • **GUHRING NAVIGATOR**
- M** • Cutting data page 326
- K** •
- N** •
- S** •
 - neck clearance
 - centre cutting
- H** • consisting of art. no. 6737

Tool material	Solid carbide
Surface	Ⓚ
Type	N
Shank form	HA



Article no. **6755**

Ø-range mm	Pieces/set	Code no.
5,7/7,7/9,7/11,7/15,6	5	1.000
6/8/10/12/16	5	2.000

ISO	Hardness	vc	fz (mm/z) / Ø							vc	fz (mm/z) / Ø							
			3	6	8	10	12	16	20		3	6	8	10	12	16	20	
P	≤ 850 N/mm ²	270	0,017	0,025	0,034	0,050	0,060	0,080	0,100	HPC	450	0,027	0,040	0,054	0,080	0,10	0,13	0,16
	≥ 850 N/mm ²	180	0,014	0,021	0,028	0,045	0,054	0,072	0,090		300	0,022	0,034	0,045	0,072	0,09	0,12	0,14
M	≤ 750 N/mm ²	120	0,014	0,021	0,028	0,045	0,054	0,072	0,090	200	0,022	0,034	0,045	0,072	0,09	0,12	0,14	
	≥ 750 N/mm ²	80	0,013	0,019	0,026	0,040	0,048	0,064	0,080	140	0,020	0,031	0,041	0,064	0,08	0,10	0,13	
S	Ti-based	60	0,013	0,019	0,026	0,040	0,048	0,064	0,080	110	0,020	0,031	0,041	0,064	0,08	0,10	0,13	
K	≤ 240 HB	150	0,017	0,025	0,034	0,050	0,060	0,080	0,100	250	0,027	0,040	0,054	0,080	0,10	0,13	0,16	
N	≥ 7% Si	340	0,018	0,027	0,036	0,055	0,066	0,088	0,110	570	0,029	0,043	0,058	0,088	0,11	0,14	0,18	

Solid carbide universal milling cutters

Ratio end mill sets RF 100 Diver

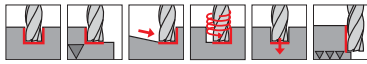
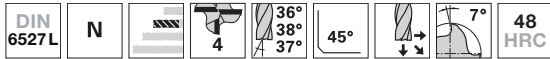

P • **GUHRING NAVIGATOR**

M • Cutting data page 326

K •

N •

S •

H •

- neck clearance
- centre cutting
- consisting of art. no. 6736

Tool material **Solid carbide**

Surface **Y**

Type **N**

Shank form **HB**



Article no. **6754**

Ø-range mm	Pieces/set	Code no.
5,7/7,7/9,7/11,7/15,6	5	1.000
6/8/10/12/16	5	2.000

ISO	Hardness	vc	fz (mm/z) / Ø							vc	fz (mm/z) / Ø							
			3	6	8	10	12	16	20		3	6	8	10	12	16	20	
P	≤ 850 N/mm ²	270	0,017	0,025	0,034	0,050	0,060	0,080	0,100	HPC	450	0,027	0,040	0,054	0,080	0,10	0,13	0,16
	≥ 850 N/mm ²	180	0,014	0,021	0,028	0,045	0,054	0,072	0,090		300	0,022	0,034	0,045	0,072	0,09	0,12	0,14
M	≤ 750 N/mm ²	120	0,014	0,021	0,028	0,045	0,054	0,072	0,090	200	0,022	0,034	0,045	0,072	0,09	0,12	0,14	
	≥ 750 N/mm ²	80	0,013	0,019	0,026	0,040	0,048	0,064	0,080	140	0,020	0,031	0,041	0,064	0,08	0,10	0,13	
S	Ti-based	60	0,013	0,019	0,026	0,040	0,048	0,064	0,080	110	0,020	0,031	0,041	0,064	0,08	0,10	0,13	
K	≤ 240 HB	150	0,017	0,025	0,034	0,050	0,060	0,080	0,100	250	0,027	0,040	0,054	0,080	0,10	0,13	0,16	
N	≥ 7% Si	340	0,018	0,027	0,036	0,055	0,066	0,088	0,110	570	0,029	0,043	0,058	0,088	0,11	0,14	0,18	



Ratio end mill sets RF 100 Speed

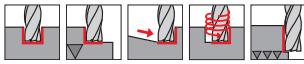

P	•	GUHRING NAVIGATOR
M	•	
K		
N		
S	•	
H		<ul style="list-style-type: none"> • centre cutting • consisting of art. no. 6765

Cutting data page 327

Tool material	Solid carbide
Surface	A
Type	NH
Shank form	HA



Article no. **6778**

Ø-range mm	Pieces/set	Code no.
6/8/10/12/16	5	1.000
6/8/10/12	4	2.000
6,0	5	6.000
8,0	5	8.000
10,0	3	10.000
12,0	3	12.000
16,0	3	16.000

ISO	Hardness	vc	fz (mm/z) / Ø								vc	fz (mm/z) / Ø							
			3	6	8	10	12	16	20	3		6	8	10	12	16	20		
P	≤ 850 N/mm ²	340	0,036	0,072	0,096	0,138	0,17	0,22	0,28	360	0,017	0,034	0,046	0,066	0,08	0,11	0,13		
	≥ 850 N/mm ²	250	0,031	0,062	0,083	0,115	0,14	0,18	0,23	270	0,015	0,030	0,040	0,055	0,07	0,09	0,11		
M	≤ 750 N/mm ²	220	0,031	0,062	0,083	0,115	0,14	0,18	0,23	240	0,015	0,030	0,040	0,055	0,07	0,09	0,11		
	≥ 750 N/mm ²	110	0,024	0,048	0,064	0,092	0,11	0,15	0,18	120	0,011	0,021	0,028	0,040	0,05	0,06	0,08		
S	Ni-based	60	0,019	0,039	0,052	0,074	0,09	0,12	0,15	60	0,008	0,017	0,022	0,032	0,04	0,05	0,06		
	Ti-based	110	0,028	0,055	0,074	0,104	0,12	0,17	0,21	120	0,013	0,026	0,035	0,050	0,06	0,08	0,10		

Solid carbide universal milling cutters

Ratio end mill sets RF 100 Speed

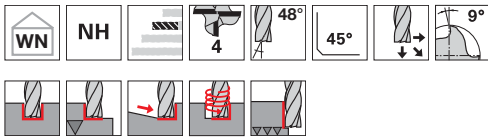

P • **GUHRING NAVIGATOR**
M • Cutting data page 327
K
N
S •
H • centre cutting
 • consisting of art. no. 6760

Tool material	Solid carbide
Surface	A
Type	NH
Shank form	HB



Article no. **6780**

Ø-range mm	Pieces/set	Code no.
6/8/10/12/16	5	1.000
6/8/10/12	4	2.000
6,0	5	6.000
8,0	5	8.000
10,0	3	10.000
12,0	3	12.000
16,0	3	16.000

Solid carbide universal milling cutters

ISO	Hardness	vc	fz (mm/z) / Ø								vc	fz (mm/z) / Ø							
			3	6	8	10	12	16	20	3		6	8	10	12	16	20		
P	≤ 850 N/mm ²	340	0,036	0,072	0,096	0,138	0,17	0,22	0,28	360	0,017	0,034	0,046	0,066	0,08	0,11	0,13		
	≥ 850 N/mm ²	250	0,031	0,062	0,083	0,115	0,14	0,18	0,23	270	0,015	0,030	0,040	0,055	0,07	0,09	0,11		
M	≤ 750 N/mm ²	220	0,031	0,062	0,083	0,115	0,14	0,18	0,23	240	0,015	0,030	0,040	0,055	0,07	0,09	0,11		
	≥ 750 N/mm ²	110	0,024	0,048	0,064	0,092	0,11	0,15	0,18	120	0,011	0,021	0,028	0,040	0,05	0,06	0,08		
S	Ni-based	60	0,019	0,039	0,052	0,074	0,09	0,12	0,15	60	0,008	0,017	0,022	0,032	0,04	0,05	0,06		
	Ti-based	110	0,028	0,055	0,074	0,104	0,12	0,17	0,21	120	0,013	0,026	0,035	0,050	0,06	0,08	0,10		



Ratio end mill sets RF 100 Speed

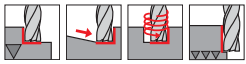

P • **GUHRING NAVIGATOR**
M • Cutting data page 327
K
N
S •
H

- with chip breaker
- re-inforced core
- centre cutting
- consisting of art. no. 6766

Tool material	Solid carbide
Surface	A
Type	NH
Shank form	HA



Article no. **6777**

Ø-range	Pieces/set	Code no.
mm		
6,0	5	6.000
8,0	5	8.000
10,0	3	10.000
12,0	3	12.000
16,0	3	16.000

ISO	Hardness	vc	fz (mm/z) / Ø							vc	fz (mm/z) / Ø						
			3	6	8	10	12	16	20		3	6	8	10	12	16	20
			ap = l2		HPC	HSC		ae max. = 0,10 x D			ap = l2			ae max. = 0,02 x D			
P	≤ 850 N/mm ²	340	0,036	0,072	0,096	0,138	0,17	0,22	0,28	360	0,017	0,034	0,046	0,066	0,08	0,11	0,13
	≥ 850 N/mm ²	250	0,031	0,062	0,083	0,115	0,14	0,18	0,23	270	0,015	0,030	0,040	0,055	0,07	0,09	0,11
M	≤ 750 N/mm ²	220	0,031	0,062	0,083	0,115	0,14	0,18	0,23	240	0,015	0,030	0,040	0,055	0,07	0,09	0,11
	≥ 750 N/mm ²	110	0,024	0,048	0,064	0,092	0,11	0,15	0,18	120	0,011	0,021	0,028	0,040	0,05	0,06	0,08
S	Ni-based	60	0,019	0,039	0,052	0,074	0,09	0,12	0,15	60	0,008	0,017	0,022	0,032	0,04	0,05	0,06
	Ti-based	110	0,028	0,055	0,074	0,104	0,12	0,17	0,21	120	0,013	0,026	0,035	0,050	0,06	0,08	0,10

Solid carbide universal milling cutters

Ratio end mill sets RF 100 Speed

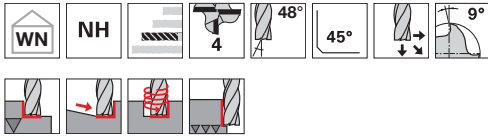

P • **GUHRING NAVIGATOR**
M • Cutting data page 327
K
N
S •
H
 • with chip breaker
 • re-inforced core
 • centre cutting
 • consisting of art. no. 6761

Tool material	Solid carbide
Surface	A
Type	NH
Shank form	HB



Article no. **6781**

Ø-range	Pieces/set	Code no.
mm		
6,0	5	6.000
8,0	5	8.000
10,0	3	10.000
12,0	3	12.000
16,0	3	16.000

ISO	Hardness	vc	fz (mm/z) / Ø							vc	fz (mm/z) / Ø						
			3	6	8	10	12	16	20		3	6	8	10	12	16	20
P	≤ 850 N/mm ²	340	0,036	0,072	0,096	0,138	0,17	0,22	0,28	360	0,017	0,034	0,046	0,066	0,08	0,11	0,13
	≥ 850 N/mm ²	250	0,031	0,062	0,083	0,115	0,14	0,18	0,23		270	0,015	0,030	0,040	0,055	0,07	0,09
M	≤ 750 N/mm ²	220	0,031	0,062	0,083	0,115	0,14	0,18	0,23	240	0,015	0,030	0,040	0,055	0,07	0,09	0,11
	≥ 750 N/mm ²	110	0,024	0,048	0,064	0,092	0,11	0,15	0,18		120	0,011	0,021	0,028	0,040	0,05	0,06
S	Ni-based	60	0,019	0,039	0,052	0,074	0,09	0,12	0,15	60	0,008	0,017	0,022	0,032	0,04	0,05	0,06
	Ti-based	110	0,028	0,055	0,074	0,104	0,12	0,17	0,21		120	0,013	0,026	0,035	0,050	0,06	0,08

Solid carbide universal milling cutters



Ratio end mill sets RF 100 U Z3

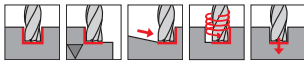

- P** • **GUHRING NAVIGATOR**
M • Cutting data page 328
K •
N •
S ○ • neck clearance
 • centre cutting
H • consisting of art. no. 3892

Tool material	Solid carbide
Surface	F
Type	NH
Shank form	HB



Article no. **4372**

Ø-range	Pieces/set	Code no.
mm		
6/8/10/12	4	1.000

ISO	Hardness	vc	fz (mm/z) / Ø							vc	fz (mm/z) / Ø						
			3	6	8	10	12	16	20		3	6	8	10	12	16	20
P	≤ 850 N/mm ²	180	0,016	0,031	0,042	0,060	0,07	0,10	0,12	210	0,018	0,036	0,048	0,069	0,08	0,11	0,14
	≥ 850 N/mm ²	135	0,014	0,027	0,036	0,050	0,06	0,08	0,10		160	0,016	0,031	0,041	0,058	0,07	0,09
M	≤ 750 N/mm ²	120	0,014	0,027	0,036	0,050	0,06	0,08	0,10	140	0,016	0,031	0,041	0,058	0,07	0,09	0,12
	≥ 750 N/mm ²	60	0,011	0,021	0,028	0,040	0,05	0,06	0,08		80	0,013	0,025	0,034	0,048	0,06	0,08
S	Ni-based	30	0,008	0,017	0,022	0,032	0,04	0,05	0,06	40	0,010	0,020	0,027	0,038	0,05	0,06	0,08
	Ti-based	60	0,012	0,024	0,032	0,045	0,05	0,07	0,09		80	0,014	0,029	0,038	0,054	0,06	0,09
N	≤ 5% Si	500	0,020	0,039	0,052	0,080	0,10	0,13	0,16	600	0,022	0,045	0,060	0,092	0,11	0,15	0,18
	≥ 5% Si	230	0,017	0,033	0,044	0,060	0,07	0,10	0,12		300	0,019	0,038	0,051	0,069	0,08	0,11

Solid carbide universal milling cutters

Ratio end mill sets RF 100 U

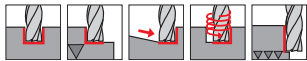
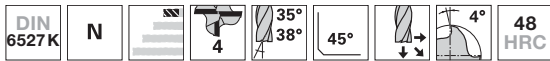

P • **GUHRING NAVIGATOR**

M ○ Cutting data page 328

K •

N ○

S ○

H ○

- neck clearance
- centre cutting
- consisting of art. no. 5534

Tool material	Solid carbide
Surface	F
Type	N
Shank form	HB



Article no. **5634**

Ø-range	Pieces/set	Code no.
mm		
6/8/10/12/16	5	1.000

ISO	Hardness	vc	fz (mm/z) / Ø							vc	fz (mm/z) / Ø							
			3	6	8	10	12	16	20		3	6	8	10	12	16	20	
P	≤ 850 N/mm ²	180	0,016	0,031	0,042	0,060	0,07	0,10	0,12		305	0,025	0,050	0,067	0,096	0,12	0,15	0,19
	≥ 850 N/mm ²	135	0,014	0,027	0,036	0,050	0,06	0,08	0,10		230	0,022	0,043	0,058	0,080	0,10	0,13	0,16
K	≤ 240 HB	160	0,017	0,033	0,044	0,065	0,08	0,10	0,13		270	0,026	0,053	0,070	0,104	0,12	0,17	0,21
	≥ 240 HB	140	0,015	0,030	0,040	0,055	0,07	0,09	0,11		240	0,024	0,048	0,064	0,088	0,11	0,14	0,18



Ratio end mill sets RF 100 U

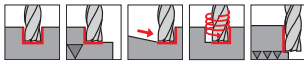

P • **GUHRING NAVIGATOR**
M ○ Cutting data page 328
K •
N ○
S ○ • neck clearance
H ○ • centre cutting
 • consisting of art. no. 5735

Tool material	Solid carbide
Surface	F
Type	N
Shank form	HA



Article no. **5645**

Ø-range	Pieces/set	Code no.
mm		
6/8/10/12	4	1.000

ISO	Hardness	vc	fz (mm/z) / Ø							vc	fz (mm/z) / Ø							
			3	6	8	10	12	16	20		3	6	8	10	12	16	20	
P	≤ 850 N/mm ²	180	0,016	0,031	0,042	0,060	0,07	0,10	0,12		305	0,025	0,050	0,067	0,096	0,12	0,15	0,19
	≥ 850 N/mm ²	135	0,014	0,027	0,036	0,050	0,06	0,08	0,10		230	0,022	0,043	0,058	0,080	0,10	0,13	0,16
K	≤ 240 HB	160	0,017	0,033	0,044	0,065	0,08	0,10	0,13		270	0,026	0,053	0,070	0,104	0,12	0,17	0,21
	≥ 240 HB	140	0,015	0,030	0,040	0,055	0,07	0,09	0,11		240	0,024	0,048	0,064	0,088	0,11	0,14	0,18

Solid carbide universal milling cutters

Ratio end mill sets RF 100 U

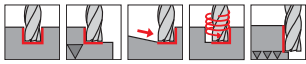

P • **GUHRING NAVIGATOR**
M ○ Cutting data page 328
K •
N ○
S ○ • neck clearance
H ○ • centre cutting
 • consisting of art. no. 5535

Tool material	Solid carbide
Surface	F
Type	N
Shank form	HB



Article no. **5635**

Ø-range		Pieces/set	Code no.
mm			
6/8/10/12/16		5	1.000

ISO	Hardness	vc	fz (mm/z) / Ø							vc	fz (mm/z) / Ø						
			3	6	8	10	12	16	20		3	6	8	10	12	16	20
P	≤ 850 N/mm ²	180	0,016	0,031	0,042	0,060	0,07	0,10	0,12	305	0,025	0,050	0,067	0,096	0,12	0,15	0,19
	≥ 850 N/mm ²	135	0,014	0,027	0,036	0,050	0,06	0,08	0,10	230	0,022	0,043	0,058	0,080	0,10	0,13	0,16
K	≤ 240 HB	160	0,017	0,033	0,044	0,065	0,08	0,10	0,13	270	0,026	0,053	0,070	0,104	0,12	0,17	0,21
	≥ 240 HB	140	0,015	0,030	0,040	0,055	0,07	0,09	0,11	240	0,024	0,048	0,064	0,088	0,11	0,14	0,18

Solid carbide universal milling cutters



Ratio end mill sets RF 100 VA

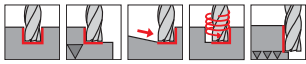

P • **GUHRING NAVIGATOR**
M • Cutting data page 328
K
N ○
S •
H
 • neck clearance
 • centre cutting
 • consisting of art. no. 3803

Tool material	Solid carbide
Surface	a
Type	N
Shank form	HB



Article no.		4370
Ø-range	Pieces/set	Code no.
mm		
6/8/10/12/16	5	1.000

ISO	Hardness	vc	fz (mm/z) / Ø							vc	fz (mm/z) / Ø							
			3	6	8	10	12	16	20		3	6	8	10	12	16	20	
P	≤ 850 N/mm ²	180	0,016	0,031	0,042	0,060	0,07	0,10	0,12	HPC	305	0,025	0,050	0,067	0,096	0,12	0,15	0,19
	≥ 850 N/mm ²	135	0,014	0,027	0,036	0,050	0,06	0,08	0,10		230	0,022	0,043	0,058	0,080	0,10	0,13	0,16
M	≤ 750 N/mm ²	120	0,014	0,027	0,036	0,050	0,06	0,08	0,10	205	0,022	0,043	0,058	0,080	0,10	0,13	0,16	
	≥ 750 N/mm ²	60	0,011	0,021	0,028	0,040	0,05	0,06	0,08	100	0,017	0,034	0,045	0,064	0,08	0,10	0,13	
S	Ni-based	30	0,008	0,017	0,022	0,032	0,04	0,05	0,06	50	0,013	0,027	0,036	0,051	0,06	0,08	0,10	
	Ti-based	60	0,012	0,024	0,032	0,045	0,05	0,07	0,09	100	0,019	0,038	0,051	0,072	0,09	0,12	0,14	
K	≤ 240 HB	160	0,017	0,033	0,044	0,065	0,08	0,10	0,13	270	0,026	0,053	0,070	0,104	0,12	0,17	0,21	
	≥ 240 HB	140	0,015	0,030	0,040	0,055	0,07	0,09	0,11	240	0,024	0,048	0,064	0,088	0,11	0,14	0,18	

Solid carbide universal milling cutters

Ratio end mill sets RF 100 VA NF

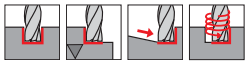

- P** • **GUHRING NAVIGATOR**
M • Cutting data page 329
K •
N ○
S ○ • neck clearance
H • centre cutting
 • consisting of art. no. 3718

Tool material	Solid carbide
Surface	a
Type	NF
Shank form	HB



Article no. **4371**

Ø-range	Pieces/set	Code no.
mm		
6/8/10/12/16	5	1.000

ISO	Hardness	vc	fz (mm/z) / Ø							vc	fz (mm/z) / Ø							
			3	6	8	10	12	16	20		3	6	8	10	12	16	20	
P	≤ 850 N/mm ²	135	0,009	0,018	0,024	0,032	0,038	0,051	0,064		160	0,010	0,021	0,028	0,037	0,044	0,059	0,074
	≥ 850 N/mm ²	100	0,008	0,017	0,022	0,030	0,036	0,048	0,060		120	0,010	0,019	0,026	0,035	0,041	0,055	0,069
M	≤ 750 N/mm ²	90	0,008	0,017	0,022	0,030	0,036	0,048	0,060		110	0,010	0,019	0,026	0,035	0,041	0,055	0,069
	≥ 750 N/mm ²	55	0,007	0,013	0,018	0,025	0,030	0,040	0,050		70	0,008	0,016	0,021	0,030	0,036	0,048	0,060
S	Ni-based	25	0,006	0,012	0,016	0,022	0,026	0,035	0,044		40	0,007	0,014	0,019	0,026	0,032	0,042	0,053
	Ti-based	50	0,007	0,013	0,018	0,025	0,030	0,040	0,050		70	0,008	0,016	0,021	0,030	0,036	0,048	0,060
K	≤ 240 HB	120	0,009	0,018	0,024	0,032	0,038	0,051	0,064		140	0,010	0,021	0,028	0,037	0,044	0,059	0,074
	≥ 240 HB	105	0,008	0,017	0,022	0,030	0,036	0,048	0,060		130	0,010	0,019	0,026	0,035	0,041	0,055	0,069

Solid carbide universal milling cutters



High-performance roughing end mills RS 100 U, set



Tool material	Solid carbide
Surface	F
Type	NF
Shank form	HA

P • **GUHRING NAVIGATOR**
M • Cutting data page 329
K •
N ○
S •
H ○

- neck clearance
- centre cutting
- consisting of art. no. 3887



Article no. **4352**

Ø-range	Pieces/set	Code no.
mm		
6/8/10/12	4	1.000

ISO	Hardness	vc	fz (mm/z) / Ø							vc	fz (mm/z) / Ø							
			3	6	8	10	12	16	20		3	6	8	10	12	16	20	
P	≤ 850 N/mm ²	135	0,009	0,018	0,024	0,032	0,038	0,051	0,064		160	0,010	0,021	0,028	0,037	0,044	0,059	0,074
	≥ 850 N/mm ²	100	0,008	0,017	0,022	0,030	0,036	0,048	0,060		120	0,010	0,019	0,026	0,035	0,041	0,055	0,069
M	≤ 750 N/mm ²	90	0,008	0,017	0,022	0,030	0,036	0,048	0,060		110	0,010	0,019	0,026	0,035	0,041	0,055	0,069
	≥ 750 N/mm ²	55	0,007	0,013	0,018	0,025	0,030	0,040	0,050		70	0,008	0,016	0,021	0,030	0,036	0,048	0,060
S	Ni-based	25	0,006	0,012	0,016	0,022	0,026	0,035	0,044		40	0,007	0,014	0,019	0,026	0,032	0,042	0,053
	Ti-based	50	0,007	0,013	0,018	0,025	0,030	0,040	0,050		70	0,008	0,016	0,021	0,030	0,036	0,048	0,060
K	≤ 240 HB	120	0,009	0,018	0,024	0,032	0,038	0,051	0,064		140	0,010	0,021	0,028	0,037	0,044	0,059	0,074
	≥ 240 HB	105	0,008	0,017	0,022	0,030	0,036	0,048	0,060		130	0,010	0,019	0,026	0,035	0,041	0,055	0,069

Solid carbide universal milling cutters

High-performance roughing end mills RS 100 U, set



Tool material	Solid carbide
Surface	F
Type	NF
Shank form	HA

P • **GUHRING NAVIGATOR**
M • Cutting data page 329
K •
N ○
S •
H ○

- neck clearance
- centre cutting
- consisting of art. no. 3887



Article no. **4345**

Ø-range	Pieces/set	Code no.
mm		
6/8/10/12/16	5	1.000

ISO	Hardness	vc	fz (mm/z) / Ø							vc	fz (mm/z) / Ø							
			3	6	8	10	12	16	20		3	6	8	10	12	16	20	
P	≤ 850 N/mm ²	135	0,009	0,018	0,024	0,032	0,038	0,051	0,064		160	0,010	0,021	0,028	0,037	0,044	0,059	0,074
	≥ 850 N/mm ²	100	0,008	0,017	0,022	0,030	0,036	0,048	0,060		120	0,010	0,019	0,026	0,035	0,041	0,055	0,069
M	≤ 750 N/mm ²	90	0,008	0,017	0,022	0,030	0,036	0,048	0,060		110	0,010	0,019	0,026	0,035	0,041	0,055	0,069
	≥ 750 N/mm ²	55	0,007	0,013	0,018	0,025	0,030	0,040	0,050		70	0,008	0,016	0,021	0,030	0,036	0,048	0,060
S	Ni-based	25	0,006	0,012	0,016	0,022	0,026	0,035	0,044		40	0,007	0,014	0,019	0,026	0,032	0,042	0,053
	Ti-based	50	0,007	0,013	0,018	0,025	0,030	0,040	0,050		70	0,008	0,016	0,021	0,030	0,036	0,048	0,060
K	≤ 240 HB	120	0,009	0,018	0,024	0,032	0,038	0,051	0,064		140	0,010	0,021	0,028	0,037	0,044	0,059	0,074
	≥ 240 HB	105	0,008	0,017	0,022	0,030	0,036	0,048	0,060		130	0,010	0,019	0,026	0,035	0,041	0,055	0,069

Solid carbide universal milling cutters



High-performance roughing end mills RS 100 U, set

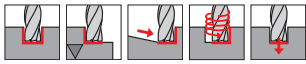

P • **GUHRING NAVIGATOR**
M • Cutting data page 329
K •
N ○
S •
H •

- neck clearance
- centre cutting
- consisting of art. no. 3888

Tool material	Solid carbide
Surface	F
Type	NF
Shank form	HB



Article no. **4344**

Ø-range	Pieces/set	Code no.
mm		
6/8/10/12/16	5	1.000

ISO	Hardness	vc	fz (mm/z) / Ø							vc	fz (mm/z) / Ø							
			3	6	8	10	12	16	20		3	6	8	10	12	16	20	
P	≤ 850 N/mm ²	135	0,009	0,018	0,024	0,032	0,038	0,051	0,064		160	0,010	0,021	0,028	0,037	0,044	0,059	0,074
	≥ 850 N/mm ²	100	0,008	0,017	0,022	0,030	0,036	0,048	0,060		120	0,010	0,019	0,026	0,035	0,041	0,055	0,069
M	≤ 750 N/mm ²	90	0,008	0,017	0,022	0,030	0,036	0,048	0,060		110	0,010	0,019	0,026	0,035	0,041	0,055	0,069
	≥ 750 N/mm ²	55	0,007	0,013	0,018	0,025	0,030	0,040	0,050		70	0,008	0,016	0,021	0,030	0,036	0,048	0,060
S	Ni-based	25	0,006	0,012	0,016	0,022	0,026	0,035	0,044		40	0,007	0,014	0,019	0,026	0,032	0,042	0,053
	Ti-based	50	0,007	0,013	0,018	0,025	0,030	0,040	0,050		70	0,008	0,016	0,021	0,030	0,036	0,048	0,060
K	≤ 240 HB	120	0,009	0,018	0,024	0,032	0,038	0,051	0,064		140	0,010	0,021	0,028	0,037	0,044	0,059	0,074
	≥ 240 HB	105	0,008	0,017	0,022	0,030	0,036	0,048	0,060		130	0,010	0,019	0,026	0,035	0,041	0,055	0,069

Solid carbide universal milling cutters

High-performance roughing end mills RS 100 F, set

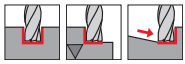
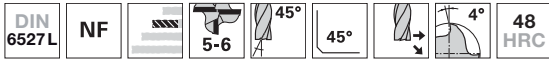

P • **GUHRING NAVIGATOR**
M Cutting data page 329
K •
N
S
H ○

- neck clearance
- centre cutting
- consisting of art. no. 3889

Tool material	Solid carbide
Surface	F
Type	NF
Shank form	HA



Article no. **4353**

Ø-range	Pieces/set	Code no.
mm		
6/8/10/12	4	1.000

ISO	Hardness	vc	fz (mm/z) / Ø							vc	fz (mm/z) / Ø							
			3	6	8	10	12	16	20		3	6	8	10	12	16	20	
P	≤ 850 N/mm ²	135	0,009	0,018	0,024	0,032	0,038	0,051	0,064		160	0,010	0,021	0,028	0,037	0,044	0,059	0,074
	≥ 850 N/mm ²	100	0,008	0,017	0,022	0,030	0,036	0,048	0,060		120	0,010	0,019	0,026	0,035	0,041	0,055	0,069
K	≤ 240 HB	120	0,009	0,018	0,024	0,032	0,038	0,051	0,064		140	0,010	0,021	0,028	0,037	0,044	0,059	0,074
	≥ 240 HB	105	0,008	0,017	0,022	0,030	0,036	0,048	0,060		130	0,010	0,019	0,026	0,035	0,041	0,055	0,069



High-performance roughing end mills RS 100 F, set

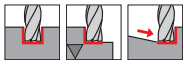
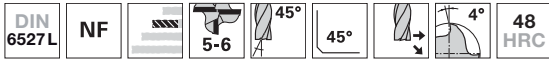

P • **GUHRING NAVIGATOR**
M Cutting data page 329
K •
N
S
H ○

- neck clearance
- centre cutting
- consisting of art. no. 3889

Tool material	Solid carbide
Surface	F
Type	NF
Shank form	HA



Article no. **4348**

Ø-range	Pieces/set	Code no.
mm		
6/8/10/12/16	5	1.000

ISO	Hardness	vc	fz (mm/z) / Ø							vc	fz (mm/z) / Ø						
			3	6	8	10	12	16	20		3	6	8	10	12	16	20
P	≤ 850 N/mm ²	135	0,009	0,018	0,024	0,032	0,038	0,051	0,064	160	0,010	0,021	0,028	0,037	0,044	0,059	0,074
	≥ 850 N/mm ²	100	0,008	0,017	0,022	0,030	0,036	0,048	0,060	120	0,010	0,019	0,026	0,035	0,041	0,055	0,069
K	≤ 240 HB	120	0,009	0,018	0,024	0,032	0,038	0,051	0,064	140	0,010	0,021	0,028	0,037	0,044	0,059	0,074
	≥ 240 HB	105	0,008	0,017	0,022	0,030	0,036	0,048	0,060	130	0,010	0,019	0,026	0,035	0,041	0,055	0,069

Solid carbide universal milling cutters

High-performance roughing end mills RS 100 F, set

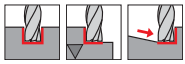
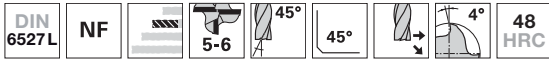

P • **GUHRING NAVIGATOR**

M Cutting data page 329

K •

N

S

H ○

- neck clearance
- centre cutting
- consisting of art. no. 3890

Tool material	Solid carbide
Surface	F
Type	NF
Shank form	HB



Article no. **4347**

Ø-range	Pieces/set	Code no.
mm		
6/8/10/12/16	5	1.000

ISO	Hardness	vc	fz (mm/z) / Ø							vc	fz (mm/z) / Ø							
			3	6	8	10	12	16	20		3	6	8	10	12	16	20	
P	≤ 850 N/mm ²	135	0,009	0,018	0,024	0,032	0,038	0,051	0,064		160	0,010	0,021	0,028	0,037	0,044	0,059	0,074
	≥ 850 N/mm ²	100	0,008	0,017	0,022	0,030	0,036	0,048	0,060		120	0,010	0,019	0,026	0,035	0,041	0,055	0,069
K	≤ 240 HB	120	0,009	0,018	0,024	0,032	0,038	0,051	0,064		140	0,010	0,021	0,028	0,037	0,044	0,059	0,074
	≥ 240 HB	105	0,008	0,017	0,022	0,030	0,036	0,048	0,060		130	0,010	0,019	0,026	0,035	0,041	0,055	0,069



Slot drills (2-fluted), set



Tool material	Solid carbide
Surface	F
Type	N
Shank form	HB

P • **GUHRING NAVIGATOR**
M • Cutting data page 335
K •
N •
S •
H •
 • centre cutting
 • consisting of art. no. 3154



Article no. **3798**

Ø-range	Pieces/set	Code no.
mm		
6/8/10/12	4	1.000

ISO	Hardness	vc	fz (mm/z) / Ø							vc	fz (mm/z) / Ø							
			3	6	8	10	12	16	20		3	6	8	10	12	16	20	
P	≤ 850 N/mm ²	120	0,012	0,024	0,032	0,042	0,05	0,07	0,08		140	0,014	0,028	0,037	0,048	0,06	0,08	0,10
	≥ 850 N/mm ²	90	0,011	0,021	0,028	0,039	0,05	0,06	0,08		110	0,012	0,024	0,032	0,045	0,05	0,07	0,09
M	≤ 750 N/mm ²	80	0,008	0,017	0,022	0,030	0,04	0,05	0,06		100	0,010	0,019	0,026	0,035	0,04	0,06	0,07
	≥ 750 N/mm ²	50	0,006	0,013	0,017	0,024	0,03	0,04	0,05		70	0,008	0,015	0,020	0,029	0,03	0,05	0,06
K	≤ 240 HB	110	0,011	0,022	0,030	0,039	0,05	0,06	0,08	130	0,013	0,026	0,034	0,045	0,05	0,07	0,09	
N	≥ 7% Si	160	0,016	0,031	0,042	0,056	0,07	0,09	0,11	190	0,018	0,036	0,048	0,064	0,08	0,10	0,13	

Solid carbide universal milling cutters

Slot drills GH 100 U (3-fluted), set

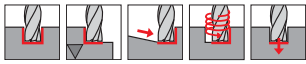

P • **GUHRING NAVIGATOR**
M • Cutting data page 330
K •
N ○
S ○
H ○

- centre cutting
- consisting of art. no. 5546

Tool material	Solid carbide
Surface	F
Type	NH
Shank form	HB



Article no. **5636**

Ø-range	Pieces/set	Code no.
mm		
6/8/10/12/16	5	1.000

ISO	Hardness	vc	fz (mm/z) / Ø							vc	fz (mm/z) / Ø						
			ap = 1,0 x D			ae = 1,0 x D					ap = 1,0 x D			ae = 0,75 x D			
P	≤ 850 N/mm ²	120	0,012	0,024	0,032	0,045	0,05	0,07	0,09	140	0,014	0,028	0,037	0,052	0,06	0,08	0,10
	≥ 850 N/mm ²	90	0,011	0,023	0,030	0,042	0,05	0,07	0,08	110	0,013	0,026	0,035	0,048	0,06	0,08	0,10
M	≤ 750 N/mm ²	80	0,011	0,023	0,030	0,042	0,05	0,07	0,08	100	0,013	0,026	0,035	0,048	0,06	0,08	0,10
	≥ 750 N/mm ²	40	0,010	0,020	0,026	0,035	0,04	0,06	0,07	50	0,012	0,024	0,032	0,042	0,05	0,07	0,08
S	Ni-based	20	0,008	0,015	0,020	0,030	0,04	0,05	0,06	30	0,009	0,018	0,024	0,036	0,04	0,06	0,07
	Ti-based	40	0,010	0,020	0,026	0,038	0,05	0,06	0,08	50	0,012	0,024	0,032	0,046	0,05	0,07	0,09
K	≤ 240 HB	105	0,012	0,024	0,032	0,045	0,05	0,07	0,09	130	0,014	0,028	0,037	0,052	0,06	0,08	0,10
	≥ 240 HB	90	0,011	0,023	0,030	0,042	0,05	0,07	0,08	110	0,013	0,026	0,035	0,048	0,06	0,08	0,10

Solid carbide universal milling cutters



End mills (4-fluted), set



Tool material	Solid carbide
Surface	F
Type	N
Shank form	HB

P • **GUHRING NAVIGATOR**
M • Cutting data page 335
K •
N •
S •
H •
 • centre cutting
 • consisting of art. no. 3722



Article no. **3799**

Ø-range	Pieces/set	Code no.
mm		
6/8/10/12	4	1.000

ISO	Hardness	vc	fz (mm/z) / Ø							vc	fz (mm/z) / Ø							
			3	6	8	10	12	16	20		3	6	8	10	12	16	20	
P	≤ 850 N/mm ²	120	0,012	0,024	0,032	0,042	0,05	0,07	0,08		140	0,014	0,028	0,037	0,048	0,06	0,08	0,10
	≥ 850 N/mm ²	90	0,011	0,021	0,028	0,039	0,05	0,06	0,08		110	0,012	0,024	0,032	0,045	0,05	0,07	0,09
M	≤ 750 N/mm ²	80	0,008	0,017	0,022	0,030	0,04	0,05	0,06		100	0,010	0,019	0,026	0,035	0,04	0,06	0,07
	≥ 750 N/mm ²	50	0,006	0,013	0,017	0,024	0,03	0,04	0,05		70	0,008	0,015	0,020	0,029	0,03	0,05	0,06
K	≤ 240 HB	110	0,011	0,022	0,030	0,039	0,05	0,06	0,08	130	0,013	0,026	0,034	0,045	0,05	0,07	0,09	
N	≥ 7% Si	160	0,016	0,031	0,042	0,056	0,07	0,09	0,11	190	0,018	0,036	0,048	0,064	0,08	0,10	0,13	

Solid carbide universal milling cutters

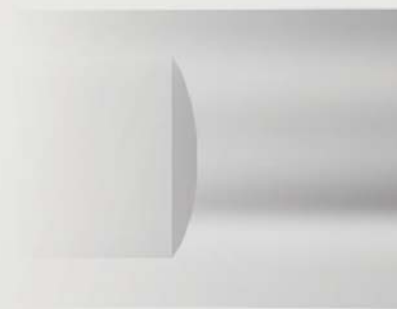

HSS

**HIGH PERFORMANCE MILLING CUTTERS HSS-E-PM
UNIVERSAL MILLING CUTTERS M42**



**- E - P M
M 4 2**

P	M	K	N	S	H	Tool illustration	Z	Hardness	Shank form	Length	Helix angle °	Tool material	Surface	d1/mm	Article no.	Page
Ratio end mills RF 40																
•	•	•	•	•	•				B			HSS-E-PM	○	8.000 - 30.000	3429	287
•	•	•	•	•	•				B			HSS-E-PM	Ⓡ	8.000 - 30.000	3705	287
•	•	•	•	•	•				B			HSS-E-PM	○	16.000 - 30.000	3432	288
•	•	•	•	•	•				B			HSS-E-PM	Ⓡ	16.000 - 30.000	3706	288
Roughing end mills GS 40 with fine teeth																
•	•	•	•	•	•				B			HSS-E-PM	○	6.000 - 20.000	3322	289
•	•	•	•	•	•				B			HSS-E-PM	Ⓡ	6.000 - 20.000	3668	289
•	•	•	•	•	•				B			HSS-E-PM	○	6.000 - 32.000	3340	290
•	•	•	•	•	•				B			HSS-E-PM	Ⓡ	6.000 - 32.000	3660	290
Roughing end mills GS 80 with fine teeth																
•	•	•	•	•	•				B			HSS-E-PM	Ⓡ	4.000 - 25.000	6756	292



P	M	K	N	S	H	Tool illustration	Z	Hardness	Shank form	Length	Helix angle °	Tool material	Surface	d1/mm	Article no.	Page
---	---	---	---	---	---	-------------------	---	----------	------------	--------	---------------	---------------	---------	-------	-------------	------

Slot drills (2-fluted)

•	○	•	•	•					B			HSCO	○	1.000 - 25.000	3451	293
•	○	•	•	•					B			HSCO	Ⓡ	1.000 - 25.000	3663	293
•	○	•	•	•					B			HSCO	○	3.000 - 20.000	3452	294
•	○	•	•	•					B			HSCO	Ⓡ	3.000 - 20.000	3694	294
•	○	•	•	•					B			HSCO	○	3.000 - 20.000	3453	295
•	○	•	•	•					B			HSCO	Ⓡ	3.000 - 20.000	3695	295

Ball nose slot drills (2-fluted)

•	○	•	•	•					B			HSCO	○	2.000 - 30.000	3466	296
•	•	•	•	•					B			HSCO	Ⓡ	2.000 - 30.000	3703	296
•	○	•	•	•					B			HSCO	○	3.000 - 30.000	3467	297
•	•	•	•	•					B			HSCO	Ⓡ	3.000 - 30.000	3704	297

Mini slot drills (3-fluted)

•	•	•	•	•					B			HSCO	○	3.000 - 10.000	3142	298
•	•	•	•	•					B			HSCO	Ⓡ	3.000 - 10.000	3144	298
•	•	•	•	•					B			HSCO	○	3.000 - 10.000	3143	299
•	•	•	•	•					B			HSCO	Ⓡ	3.000 - 10.000	3145	299

Slot drills (3-fluted)

•	○	•	•	•					B			M42	○	2.800 - 30.000	3458	300
•	○	•	•	•					B			HSCO	Ⓡ	2.800 - 30.000	3651	300
•	○	•	•	•					B			M42	○	2.800 - 20.000	3459	301
•	○	•	•	•					B			HSCO	Ⓡ	2.800 - 20.000	3664	301
•	○	•	•	•					B			HSCO	○	3.000 - 20.000	3460	302
•	○	•	•	•					B			HSCO	Ⓡ	3.000 - 20.000	3836	302

End mills

•	○	•	•	•					B			HSCO	○	2.000 - 32.000	3428	303
---	---	---	---	---	--	--	--	--	---	--	--	------	---	----------------	------	-----

Universal milling cutters M42

P	M	K	N	S	H	Tool illustration	Z	Hardness	Shank form	Length	Helix angle °	Tool material	Sur-face	d1/mm	Article no.	Page
End mills																
•	○	•	•				4-6		B		30°	HSCO	F	2.000 - 32.000	3670	303
•	○	•	•				4-6		B		30°	HSCO	○	3.000 - 40.000	3431	304
•	○	•	•				4-6		B		30°	HSCO	F	3.000 - 40.000	3692	304
•	○	•	•				4		B		30°	HSCO	○	6.000 - 20.000	3433	305
Roughing end mills																
•	○	•	•				4-6		B		30°	M42	○	6.000 - 40.000	3346	306
•	○	•	•				4-6		B		30°	HSCO	F	6.000 - 40.000	3690	306
•	○	•	•				4-6		B		30°	HSCO	○	6.000 - 36.000	3347	307
•	○	•	•				4-6		B		30°	HSCO	F	6.000 - 36.000	3650	307
Roughing/finishing end mills																
•	○	•	•				6+		B		30°	M42	○	6.000 - 40.000	3343	308
•	○	•	•				6+		B		30°	HSCO	F	6.000 - 40.000	3669	308
•	○	•	•				4-6		B		30°	HSCO	○	6.000 - 36.000	3342	309
•	○	•	•				4		B		30°	HSCO	F	6.000 - 36.000	3698	309
Morse taper end mills																
•	○	•	•				4-8		MK		30°	HSCO	○	10.000 - 50.000	3117	310
•	○	•	•				4-8		MK		30°	HSCO	○	14.000 - 45.000	3440	311
•	○	•	•				4-8		MK		30°	HSCO	○	16.000 - 50.000	3121	312
•	○	•	•				4-8		MK		30°	HSCO	○	16.000 - 63.000	3120	313
Side and face cutters																
•	○	•	•								15°	HSCO	○	50.000 - 160.000	3530	314
Shell end mills																
•	○	•	•				6+				30°	M42	○	40.000 - 125.000	3504	315
•	○	•	•				6+				30°	HSCO	C	40.000 - 125.000	3654	315
•	○	•	•				6+				30°	M42	○	40.000 - 125.000	3185	316



P	M	K	N	S	H	Tool illustration	Z	Hardness	Shank form	Length	Helix angle °	Tool material	Surface	d1/mm	Article no.	Page
Shell end mills																
•	○	•	•									HSCO	⊙	40.000 - 125.000	3749	316
•	○	•	•									M42	○	40.000 - 125.000	3187	317
T-slot end mills																
•	○	•	•									HSCO	○	12.500 - 32.000	3570	318
Woodruff cutters																
•	○	•	•									HSCO	○	4.500 - 45.500	3580	319
Dovetail cutters																
•	○	•	•									HSCO	○	16.000 - 32.000	3572	320
•	○	•	•									HSCO	○	16.000 - 32.000	3576	320
•	○	•	•									HSCO	○	16.000 - 32.000	3574	321
•	○	•	•									HSCO	○	16.000 - 32.000	3577	321
Quadrant milling cutters																
•	○	•	•									HSCO	○	10.000 - 58.000	3176	322

RF40 – High-performance PM roughing end mills for difficult applications in steel and high strength steels

Ratio®



Perfect smooth running
with unequal helix 35°/38°

35°

38°

Low power consumption
thanks to optimised flute geometry and extremely sharp cutting edges
Application also on less rigid machines and with unstable clamping

High heat resistance and toughness
thanks to HSS-E-PM tool material with FIRE-coating
Especially for tough and difficult-to-machine materials



Face cutting edges with
unequal cutting edge
distribution and centre
cutting for plunging



Ratio end mills RF 40



Tool material	HSS-E-PM	
Surface	○	●
Type	N	N
Shank form	B	B

P ● **GUHRING NAVIGATOR**
M ● Cutting data page 337
K ●
N ●
S ○
H ● neck clearance
 ● centre cutting

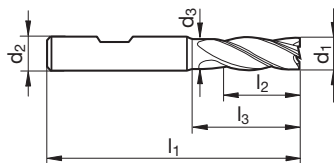

Article no. **3429** **3705**

d1 js12	d2	d3	l1	l2	l3	Z	Code no.
mm	mm	mm	mm	mm	mm		
8.00	10.00	7.70	69	19.0	21.5	4	8.000
10.00	10.00	9.50	72	22.0	30.0	4	10.000
12.00	12.00	11.50	83	26.0	36.0	4	12.000
14.00	12.00	12.00	83	26.0	38.0	4	14.000
16.00	16.00	15.50	92	32.0	42.0	4	16.000
18.00	16.00	16.00	92	32.0	44.0	4	18.000
20.00	20.00	19.00	104	38.0	52.0	4	20.000
25.00	25.00	24.00	121	45.0	63.0	4	25.000
30.00	25.00	25.00	121	45.0	65.0	6	30.000

ISO	Hardness	vc	fz (mm/z) / Ø								vc	fz (mm/z) / Ø							
			3	6	8	10	12	16	20	3		6	8	10	12	16	20		
			ap = 1,0 x D				ae = 1,0 x D					ap = 1,0 x D				ae max = 0,75 x D			
P	≤ 850 N/mm ²	60	0,013	0,025	0,034	0,045	0,05	0,07	0,09	70	0,014	0,029	0,039	0,052	0,06	0,08	0,10		
	≥ 850 N/mm ²	50	0,011	0,023	0,030	0,040	0,05	0,06	0,08	60	0,013	0,026	0,035	0,046	0,06	0,07	0,09		
M	≤ 750 N/mm ²	50	0,010	0,020	0,026	0,035	0,04	0,06	0,07	60	0,011	0,023	0,030	0,040	0,05	0,06	0,08		
	≥ 750 N/mm ²	30	0,008	0,015	0,020	0,027	0,03	0,04	0,05	40	0,009	0,018	0,024	0,032	0,04	0,05	0,06		
K	≤ 240 HB	50	0,013	0,025	0,034	0,045	0,05	0,07	0,09	60	0,014	0,029	0,039	0,052	0,06	0,08	0,10		
N	≥ 7% Si	80	0,016	0,032	0,042	0,055	0,07	0,09	0,11	100	0,018	0,037	0,049	0,063	0,08	0,10	0,13		

Please reduce cutting values for bright finish tools: vc -50% and fz -25%

High performance milling cutters HSS-E-PM

Ratio end mills RF 40



Tool material	HSS-E-PM	
Surface	○	●
Type	N	N
Shank form	B	B

P ● **GUHRING NAVIGATOR**
M ● Cutting data page 337
K ●
N ●
S ○
H ● neck clearance
 ● centre cutting

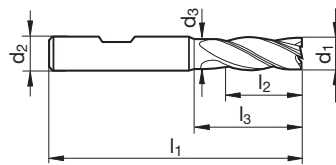

Article no. 3432 3706

d1 js12	d2	d3	l1	l2	l3	Z	Code no.
mm	mm	mm	mm	mm	mm		
16.00	16.00	15.50	123	63.0	73.0	4	16.000
18.00	16.00	15.70	123	63.0	75.0	4	18.000
18.00	16.00	16.00	123	63.0	75.0	4	18.000
20.00	20.00	19.00	141	75.0	89.0	4	20.000
25.00	25.00	24.00	166	90.0	108.0	4	25.000
30.00	25.00	25.00	166	90.0	110.0	6	30.000
30.00	25.00	24.70	166	90.0	110.0	6	30.000

ISO	Hardness	vc	fz (mm/z) / Ø							vc	fz (mm/z) / Ø						
			3	6	8	10	12	16	20		3	6	8	10	12	16	20
P	≤ 850 N/mm ²	35	0,008	0,015	0,020	0,027	0,03	0,04	0,05	50	0,010	0,020	0,027	0,036	0,04	0,06	0,07
	≥ 850 N/mm ²	30	0,007	0,014	0,018	0,024	0,03	0,04	0,05	40	0,009	0,018	0,024	0,032	0,04	0,05	0,06
M	≤ 750 N/mm ²	30	0,006	0,012	0,016	0,021	0,03	0,03	0,04	40	0,008	0,016	0,021	0,028	0,03	0,05	0,06
	≥ 750 N/mm ²	20	0,005	0,009	0,012	0,016	0,02	0,03	0,03	30	0,006	0,013	0,017	0,023	0,03	0,04	0,05
K	≤ 240 HB	30	0,008	0,015	0,020	0,027	0,03	0,04	0,05	40	0,010	0,020	0,027	0,036	0,04	0,06	0,07
N	≥ 7% Si	50	0,010	0,019	0,025	0,033	0,04	0,05	0,07	70	0,013	0,026	0,034	0,044	0,05	0,07	0,09

Please reduce cutting values for bright finish tools: vc -50% and fz -25%



Roughing end mills GS 40 with fine teeth



Tool material	HSS-E-PM	
Surface	○	●
Type	NRf	NRf
Shank form	B	B

P ● **GUHRING NAVIGATOR**
M ● Cutting data page 337
K ●
N ●
S ○
H ● neck clearance
 ● centre cutting

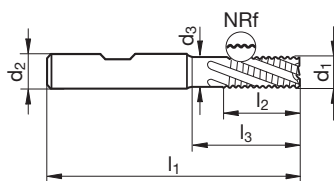

Article no. **3322** **3668**

d1 js12	d2	d3	l1	l2	l3	Z	Code no.
mm	mm	mm	mm	mm	mm		
6.00	6.00	5.70	57	13.0	20.0	3	6.000
8.00	10.00	7.70	69	19.0	21.5	3	8.000
10.00	10.00	9.50	72	22.0	30.0	3	10.000
12.00	12.00	11.50	83	26.0	36.0	3	12.000
14.00	12.00	12.00	83	26.0	38.0	3	14.000
16.00	16.00	15.50	92	32.0	42.0	3	16.000
18.00	16.00	16.00	92	32.0	44.0	3	18.000
20.00	20.00	19.00	104	38.0	52.0	3	20.000

ISO	Hardness	vc	fz (mm/z) / Ø							vc	fz (mm/z) / Ø						
			3	6	8	10	12	16	20		3	6	8	10	12	16	20
			ap = 1,0 x D								ap = 1,0 x D			ae max = 0,75 x D			
P	≤ 850 N/mm ²	60	0,013	0,025	0,034	0,045	0,05	0,07	0,09	70	0,014	0,029	0,039	0,052	0,06	0,08	0,10
	≥ 850 N/mm ²	50	0,011	0,023	0,030	0,040	0,05	0,06	0,08	60	0,013	0,026	0,035	0,046	0,06	0,07	0,09
M	≤ 750 N/mm ²	50	0,010	0,020	0,026	0,035	0,04	0,06	0,07	60	0,011	0,023	0,030	0,040	0,05	0,06	0,08
	≥ 750 N/mm ²	30	0,008	0,015	0,020	0,027	0,03	0,04	0,05	40	0,009	0,018	0,024	0,032	0,04	0,05	0,06
K	≤ 240 HB	50	0,013	0,025	0,034	0,045	0,05	0,07	0,09	60	0,014	0,029	0,039	0,052	0,06	0,08	0,10
N	≥ 7% Si	80	0,016	0,032	0,042	0,055	0,07	0,09	0,11	100	0,018	0,037	0,049	0,063	0,08	0,10	0,13

Please reduce cutting values for bright finish tools: vc -50% and fz -25%

High performance milling cutters HSS-E-PM

Roughing end mills GS 40 with fine teeth



Tool material	HSS-E-PM	
Surface	○	⦿
Type	NRf	NRf
Shank form	B	B

P • **GUHRING NAVIGATOR**
M • Cutting data page 337
K •
N •
S ○
H • neck clearance
 • centre cutting

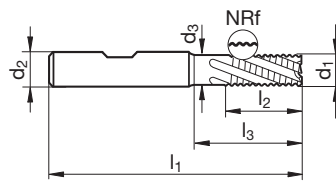

Article no. **3340** **3660**

d1 js12	d2	d3	l1	l2	l3	Z	Code no.
mm	mm	mm	mm	mm	mm		
6.00	6.00	5.70	57	13.0	20.0	4	6.000
7.00	10.00	6.70	66	16.0	17.9	4	7.000
8.00	10.00	7.70	69	19.0	21.5	4	8.000
9.00	10.00	8.70	69	19.0	24.3	4	9.000
10.00	10.00	9.50	72	22.0	30.0	4	10.000
11.00	12.00	10.50	79	22.0	30.7	4	11.000
12.00	12.00	11.50	83	26.0	36.0	4	12.000
13.00	12.00	12.00	83	26.0	38.0	4	13.000
14.00	12.00	12.00	83	26.0	38.0	4	14.000
15.00	12.00	12.00	83	26.0	38.0	4	15.000
16.00	16.00	15.50	92	32.0	42.0	4	16.000
18.00	16.00	16.00	92	32.0	44.0	4	18.000
20.00	20.00	19.00	104	38.0	52.0	4	20.000
25.00	25.00	24.00	121	45.0	63.0	5	25.000
28.00	25.00	25.00	121	45.0	65.0	5	28.000
30.00	25.00	25.00	121	45.0	65.0	5	30.000
32.00	32.00	31.00	133	53.0	71.0	6	32.000

ISO	Hardness	vc	fz (mm/z) / Ø							vc	fz (mm/z) / Ø							
			3	6	8	10	12	16	20		3	6	8	10	12	16	20	
P	≤ 850 N/mm ²	60	0,013	0,025	0,034	0,045	0,05	0,07	0,09		70	0,014	0,029	0,039	0,052	0,06	0,08	0,10
	≥ 850 N/mm ²	50	0,011	0,023	0,030	0,040	0,05	0,06	0,08		60	0,013	0,026	0,035	0,046	0,06	0,07	0,09
M	≤ 750 N/mm ²	50	0,010	0,020	0,026	0,035	0,04	0,06	0,07		60	0,011	0,023	0,030	0,040	0,05	0,06	0,08
	≥ 750 N/mm ²	30	0,008	0,015	0,020	0,027	0,03	0,04	0,05		40	0,009	0,018	0,024	0,032	0,04	0,05	0,06
K	≤ 240 HB	50	0,013	0,025	0,034	0,045	0,05	0,07	0,09	60	0,014	0,029	0,039	0,052	0,06	0,08	0,10	
N	≥ 7% Si	80	0,016	0,032	0,042	0,055	0,07	0,09	0,11	100	0,018	0,037	0,049	0,063	0,08	0,10	0,13	

Please reduce cutting values for bright finish tools: vc -50% and fz -25%

GS 80 - High-performance PM roughing end mills for difficult applications in steel and high strength steels



Optimal chip evacuation
thanks to curved, deep flute geometry

Minimum cutting pressure and power consumption
thanks to 45° helix angle and fine NRf roughing geometry
Application also on less rigid machines and with unstable clamping

High heat resistance and toughness
thanks to HSS-E-PM tool material with FIRE-coating
Especially for tough and difficult-to-machine materials

Innovative roughing geometry
ensures small chips



Roughing end mills GS 80 with fine teeth



Tool material	HSS-E-PM
Surface	F
Type	NRf
Shank form	B

P • **GUHRING NAVIGATOR**
M • Cutting data page 337
K •
N •
S ○
H • neck clearance
 • centre cutting

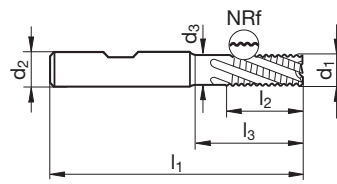

Article no. **6756**

d1 js12	d2	d3	l1	l2	l3	Z	Code no.
mm	mm	mm	mm	mm	mm		
4.00	6.00	3.70	55	11.0	15.0	3	4.000
5.00	6.00	4.70	57	13.0	18.0	4	5.000
6.00	6.00	5.70	57	13.0	20.0	4	6.000
7.00	10.00	6.70	66	16.0	22.1	4	7.000
8.00	10.00	7.70	69	19.0	26.0	4	8.000
9.00	10.00	8.70	69	19.0	26.9	4	9.000
10.00	10.00	9.50	72	22.0	30.0	4	10.000
12.00	12.00	11.50	83	26.0	36.0	4	12.000
14.00	12.00	13.50	83	26.0	38.0	5	14.000
16.00	16.00	15.50	92	32.0	42.0	5	16.000
18.00	16.00	17.50	92	32.0	44.0	6	18.000
20.00	20.00	19.00	104	38.0	52.0	6	20.000
25.00	25.00	24.00	121	45.0	63.0	6	25.000

ISO	Hardness	vc	fz (mm/z) / Ø							vc	fz (mm/z) / Ø							
			3	6	8	10	12	16	20		3	6	8	10	12	16	20	
P	≤ 850 N/mm ²	60	0,013	0,025	0,034	0,045	0,05	0,07	0,09		70	0,014	0,029	0,039	0,052	0,06	0,08	0,10
	≥ 850 N/mm ²	50	0,011	0,023	0,030	0,040	0,05	0,06	0,08		60	0,013	0,026	0,035	0,046	0,06	0,07	0,09
M	≤ 750 N/mm ²	50	0,010	0,020	0,026	0,035	0,04	0,06	0,07		60	0,011	0,023	0,030	0,040	0,05	0,06	0,08
	≥ 750 N/mm ²	30	0,008	0,015	0,020	0,027	0,03	0,04	0,05		40	0,009	0,018	0,024	0,032	0,04	0,05	0,06
K	≤ 240 HB	50	0,013	0,025	0,034	0,045	0,05	0,07	0,09	60	0,014	0,029	0,039	0,052	0,06	0,08	0,10	
N	≥ 7% Si	80	0,016	0,032	0,042	0,055	0,07	0,09	0,11	100	0,018	0,037	0,049	0,063	0,08	0,10	0,13	

High performance milling cutters HSS-E-PM



Slot drills (2-fluted)



Tool material	HSCO	
Surface	○	Ⓡ
Type	N	N
Shank form	B	B

P ● **GUHRING NAVIGATOR**
M ○ Cutting data page 338
K ●
N ●
S ●
H ● centre cutting

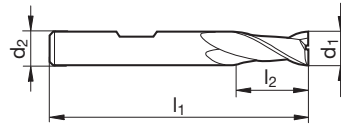

Article no. **3451** **3663**

d1	Tolerance d1	d2	l1	l2	Z	Code no.
mm		mm	mm	mm		
1.00	h10	6.00	47	2.0	2	1.000
1.50	h10	6.00	47	3.0	2	1.500
2.00	e8	6.00	48	4.0	2	2.000
2.50	e8	6.00	49	5.0	2	2.500
3.00	e8	6.00	49	5.0	2	3.000
3.50	h10	6.00	50	6.0	2	3.500
4.00	e8	6.00	51	7.0	2	4.000
4.50	h10	6.00	51	7.0	2	4.500
5.00	e8	6.00	52	8.0	2	5.000
5.50	h10	6.00	52	8.0	2	5.500
6.00	e8	6.00	52	8.0	2	6.000
6.50	h10	10.00	60	10.0	2	6.500
7.00	e8	10.00	60	10.0	2	7.000
7.50	h10	10.00	60	10.0	2	7.500
8.00	e8	10.00	61	11.0	2	8.000
8.50	h10	10.00	61	11.0	2	8.500
9.00	h10	10.00	61	11.0	2	9.000
9.50	h10	10.00	61	11.0	2	9.500
10.00	e8	10.00	63	13.0	2	10.000
10.50	h10	12.00	70	13.0	2	10.500
11.00	h10	12.00	70	13.0	2	11.000
11.50	h10	12.00	70	13.0	2	11.500
12.00	e8	12.00	73	16.0	2	12.000
13.00	h10	12.00	73	16.0	2	13.000
14.00	e8	12.00	73	16.0	2	14.000
15.00	h10	12.00	73	16.0	2	15.000
16.00	e8	16.00	79	19.0	2	16.000
17.00	h10	16.00	79	19.0	2	17.000
18.00	e8	16.00	79	19.0	2	18.000
19.00	h10	16.00	79	19.0	2	19.000
20.00	e8	20.00	88	22.0	2	20.000
22.00	e8	20.00	88	22.0	2	22.000
24.00	e8	25.00	102	26.0	2	24.000
25.00	e8	25.00	102	26.0	2	25.000

Universal milling cutters M42

Slot drills (2-fluted)



Tool material	HSCO	
Surface	○	Ⓡ
Type	N	N
Shank form	B	B

P • **GUHRING NAVIGATOR**
M ○ Cutting data page 338
K •
N •
S ○
H ○ • centre cutting

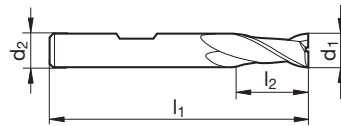

Article no. **3452** **3694**

d1	Tolerance d1	d2	l1	l2	Z	Code no.
mm		mm	mm	mm		
3.00	e8	6.00	52	8.0	2	3.000
3.50	h10	6.00	54	10.0	2	3.500
4.00	e8	6.00	55	11.0	2	4.000
4.50	h10	6.00	55	11.0	2	4.500
5.00	e8	6.00	57	13.0	2	5.000
5.50	h10	6.00	57	13.0	2	5.500
6.00	e8	6.00	57	13.0	2	6.000
7.00	e8	10.00	66	16.0	2	7.000
8.00	e8	10.00	69	19.0	2	8.000
10.00	e8	10.00	72	22.0	2	10.000
11.00	h10	12.00	79	22.0	2	11.000
12.00	e8	12.00	83	26.0	2	12.000
13.00	h10	12.00	83	26.0	2	13.000
14.00	e8	12.00	83	26.0	2	14.000
15.00	h10	12.00	83	26.0	2	15.000
16.00	e8	16.00	92	32.0	2	16.000
18.00	e8	16.00	92	32.0	2	18.000
20.00	e8	20.00	104	38.0	2	20.000



Slot drills (2-fluted)



Tool material	HSCO	
Surface	○	●
Type	N	N
Shank form	B	B

P ● **GUHRING NAVIGATOR**
M ○ Cutting data page 338
K ●
N ●
S ●
H ● centre cutting

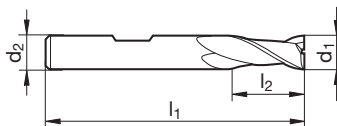

Article no. **3453** **3695**

d1	Tolerance d1	d2	l1	l2	Z	Code no.
mm		mm	mm	mm		
3.00	h10	6.00	56	12.0	2	3.000
4.00	h10	6.00	63	19.0	2	4.000
5.00	h10	6.00	68	24.0	2	5.000
6.00	h10	6.00	68	24.0	2	6.000
8.00	h10	10.00	88	38.0	2	8.000
10.00	h10	10.00	95	45.0	2	10.000
12.00	h10	12.00	110	53.0	2	12.000
14.00	h10	12.00	110	53.0	2	14.000
16.00	h10	16.00	123	63.0	2	16.000
18.00	h10	16.00	123	63.0	2	18.000
20.00	h10	20.00	141	75.0	2	20.000

Ball nose slot drills (2-fluted)



Tool material	HSCO	
Surface	○	Ⓡ
Type	N	N
Shank form	B	B

P ● **GUHRING NAVIGATOR**
M ○ Cutting data page 338
K ●
N ●
S ●
H ● centre cutting

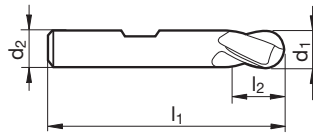

Article no. 3466 3703

d1	Tolerance d1	d2	l1	l2	Z	Code no.
mm		mm	mm	mm		
2.00	e8	6.00	48	4.0	2	2.000
3.00	e8	6.00	49	5.0	2	3.000
4.00	e8	6.00	51	7.0	2	4.000
5.00	e8	6.00	52	8.0	2	5.000
6.00	e8	6.00	52	8.0	2	6.000
7.00	e8	10.00	60	10.0	2	7.000
8.00	e8	10.00	61	11.0	2	8.000
9.00	h10	10.00	61	11.0	2	9.000
10.00	e8	10.00	63	13.0	2	10.000
11.00	h10	12.00	70	13.0	2	11.000
12.00	e8	12.00	73	16.0	2	12.000
13.00	h10	12.00	73	16.0	2	13.000
14.00	e8	12.00	73	16.0	2	14.000
15.00	h10	12.00	73	16.0	2	15.000
16.00	e8	16.00	79	19.0	2	16.000
17.00	h10	16.00	79	19.0	2	17.000
18.00	e8	16.00	79	19.0	2	18.000
19.00	h10	16.00	79	19.0	2	19.000
20.00	e8	20.00	88	22.0	2	20.000
22.00	e8	20.00	88	22.0	2	22.000
24.00	e8	25.00	102	26.0	2	24.000
25.00	e8	25.00	102	26.0	2	25.000
26.00	h10	25.00	102	26.0	2	26.000
28.00	e8	25.00	102	26.0	2	28.000
30.00	h10	25.00	102	26.0	2	30.000



Ball nose slot drills (2-fluted)



Tool material	HSCO	
Surface	○	Ⓡ
Type	N	N
Shank form	B	B

P • **GUHRING NAVIGATOR**
M ○ Cutting data page 338
K •
N •
S
H • centre cutting

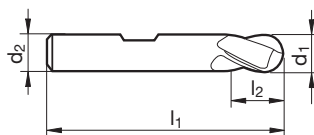

Article no. **3467** **3704**

d1	Tolerance d1	d2	l1	l2	Z	Code no.
mm		mm	mm	mm		
3.00	h10	6.00	56	8.0	2	3.000
4.00	h10	6.00	63	11.0	2	4.000
5.00	h10	6.00	68	13.0	2	5.000
6.00	h10	6.00	68	13.0	2	6.000
7.00	h10	10.00	80	16.0	2	7.000
8.00	h10	10.00	88	19.0	2	8.000
10.00	h10	10.00	95	22.0	2	10.000
12.00	h10	12.00	110	26.0	2	12.000
14.00	h10	12.00	110	26.0	2	14.000
15.00	h10	12.00	110	26.0	2	15.000
16.00	h10	16.00	123	32.0	2	16.000
18.00	h10	16.00	123	32.0	2	18.000
20.00	h10	20.00	141	38.0	2	20.000
24.00	h10	25.00	166	45.0	2	24.000
25.00	h10	25.00	166	45.0	2	25.000
30.00	h10	25.00	166	45.0	2	30.000

Mini slot drills (3-fluted)



Tool material	HSCO	
Surface	○	⊙
Type	N	N
Shank form	B	B

P • **GUHRING NAVIGATOR**
M • Cutting data page 338
K •
N •
S •
H • centre cutting

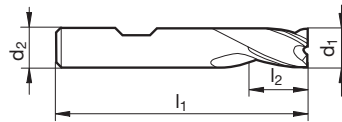

Article no. 3142 3144

d1 e8	d2	l1	l2	Z	Code no.
mm	mm	mm	mm		
3.00	6.00	36	5.0	3	3.000
4.00	6.00	38	7.0	3	4.000
5.00	6.00	39	8.0	3	5.000
6.00	6.00	39	8.0	3	6.000
8.00	8.00	43	11.0	3	8.000
10.00	10.00	50	13.0	3	10.000



Mini slot drills (3-fluted)



Tool material	HSCO	
Surface	○	Ⓡ
Type	N	N
Shank form	B	B

P • **GUHRING NAVIGATOR**
M • Cutting data page 338
K •
N •
S •
H • centre cutting

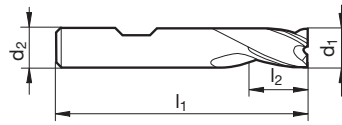

Article no. **3143** **3145**

d1 e8	d2	l1	l2	Z	Code no.
mm	mm	mm	mm		
3.00	6.00	39	8.0	3	3.000
4.00	6.00	42	11.0	3	4.000
5.00	6.00	44	13.0	3	5.000
6.00	6.00	44	13.0	3	6.000
8.00	8.00	51	19.0	3	8.000
10.00	10.00	59	22.0	3	10.000

Slot drills (3-fluted)



Tool material	M42	HSCO
Surface	○	Ⓡ
Type	N	N
Shank form	B	B

P ● **GUHRING NAVIGATOR**
M ○ Cutting data page 338
K ●
N ●
S ●
H ● centre cutting

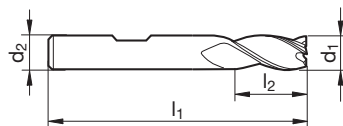

Article no. **3458** **3651**

d1	Tolerance d1	d2	l1	l2	Z	Code no.
mm		mm	mm	mm		
2.80	h10	6.00	49	5.0	3	2.800
2.80	e8	6.00	49	5.0	3	2.800
3.00	e8	6.00	49	5.0	3	3.000
3.80	e8	6.00	51	7.0	3	3.800
3.80	h10	6.00	51	7.0	3	3.800
4.00	e8	6.00	51	7.0	3	4.000
4.80	e8	6.00	52	8.0	3	4.800
4.80	h10	6.00	52	8.0	3	4.800
5.00	e8	6.00	52	8.0	3	5.000
5.75	h10	6.00	52	8.0	3	5.750
5.75	e8	6.00	52	8.0	3	5.750
6.00	e8	6.00	52	8.0	3	6.000
6.75	h10	10.00	60	10.0	3	6.750
6.75	e8	10.00	60	10.0	3	6.750
7.00	e8	10.00	60	10.0	3	7.000
7.75	e8	10.00	61	11.0	3	7.750
7.75	h10	10.00	61	11.0	3	7.750
8.00	e8	10.00	61	11.0	3	8.000
9.70	e8	10.00	63	13.0	3	9.700
9.70	h10	10.00	63	13.0	3	9.700
10.00	e8	10.00	63	13.0	3	10.000
11.70	h10	12.00	70	13.0	3	11.700
11.70	e8	12.00	70	13.0	3	11.700
12.00	e8	12.00	73	16.0	3	12.000
13.70	e8	12.00	73	16.0	3	13.700
13.70	h10	12.00	73	16.0	3	13.700
14.00	e8	12.00	73	16.0	3	14.000
15.70	e8	16.00	79	19.0	3	15.700
15.70	h10	16.00	79	19.0	3	15.700
16.00	e8	16.00	79	19.0	3	16.000
18.00	e8	16.00	79	19.0	3	18.000
20.00	e8	20.00	88	22.0	3	20.000
22.00	e8	20.00	88	22.0	3	22.000
25.00	e8	25.00	102	26.0	3	25.000
30.00	h10	25.00	102	26.0	3	30.000
30.00	e8	25.00	102	26.0	3	30.000



Slot drills (3-fluted)



Tool material	M42	HSCO
Surface	○	Ⓡ
Type	N	N
Shank form	B	B

P	•	GUHRING NAVIGATOR Cutting data page 338
M	○	
K	•	
N	•	
S	•	
H	•	• centre cutting

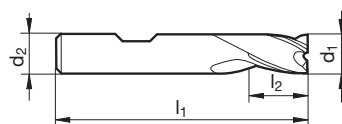
 Article no. **3459** **3664**

d1	Tolerance d1	d2	l1	l2	Z	Code no.
mm		mm	mm	mm		
2.80	h10	6.00	52	8.0	3	2.800
3.00	e8	6.00	52	8.0	3	3.000
3.80	h10	6.00	55	11.0	3	3.800
4.00	e8	6.00	55	11.0	3	4.000
4.80	h10	6.00	57	13.0	3	4.800
5.00	e8	6.00	57	13.0	3	5.000
5.75	h10	6.00	57	13.0	3	5.750
6.00	e8	6.00	57	13.0	3	6.000
6.75	h10	10.00	66	16.0	3	6.750
7.00	e8	10.00	66	16.0	3	7.000
7.75	h10	10.00	69	19.0	3	7.750
8.00	e8	10.00	69	19.0	3	8.000
9.00	h10	10.00	69	19.0	3	9.000
9.70	h10	10.00	72	22.0	3	9.700
10.00	e8	10.00	72	22.0	3	10.000
11.00	h10	12.00	79	22.0	3	11.000
11.70	h10	12.00	79	22.0	3	11.700
12.00	e8	12.00	83	26.0	3	12.000
13.70	h10	12.00	83	26.0	3	13.700
14.00	e8	12.00	83	26.0	3	14.000
15.00	h10	12.00	83	26.0	3	15.000
15.70	h10	16.00	92	32.0	3	15.700
16.00	e8	16.00	92	32.0	3	16.000
18.00	e8	16.00	92	32.0	3	18.000
20.00	e8	20.00	104	38.0	3	20.000

Slot drills (3-fluted)



Tool material	HSCO	
Surface	○	●
Type	N	N
Shank form	B	B

P ● **GUHRING NAVIGATOR**
M ○ Cutting data page 338
K ●
N ●
S ●
H ● centre cutting

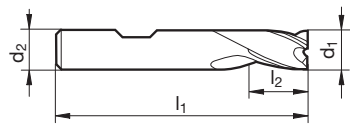

Article no. **3460** **3836**

d1	Tolerance d1	d2	l1	l2	Z	Code no.
mm		mm	mm	mm		
3.00	h10	6.00	56	12.0	3	3.000
4.00	h10	6.00	63	19.0	3	4.000
5.00	h10	6.00	68	24.0	3	5.000
6.00	h10	6.00	68	24.0	3	6.000
8.00	h10	10.00	88	38.0	3	8.000
10.00	h10	10.00	95	45.0	3	10.000
12.00	h10	12.00	110	53.0	3	12.000
14.00	h10	12.00	110	53.0	3	14.000
16.00	h10	16.00	123	63.0	3	16.000
18.00	h10	16.00	123	63.0	3	18.000
20.00	h10	20.00	141	75.0	3	20.000



End mills



Tool material

HSCO

Surface



Type

N

N

Shank form

B

B

P • **GUHRING NAVIGATOR**
M ○ Cutting data page 338

K •

N •

S
H

• centre cutting

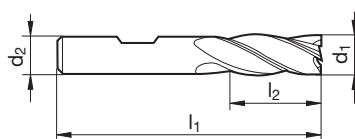

Article no.

3428
3670

d1 js12	d2	l1	l2	Z	Code no.
mm	mm	mm	mm		
2.00	6.00	51	7.0	4	2.000
2.50	6.00	52	8.0	4	2.500
3.00	6.00	52	8.0	4	3.000
3.50	6.00	54	10.0	4	3.500
4.00	6.00	55	11.0	4	4.000
4.50	6.00	55	11.0	4	4.500
5.00	6.00	57	13.0	4	5.000
5.50	6.00	57	13.0	4	5.500
6.00	6.00	57	13.0	4	6.000
6.50	10.00	66	16.0	4	6.500
7.00	10.00	66	16.0	4	7.000
7.50	10.00	66	16.0	4	7.500
8.00	10.00	69	19.0	4	8.000
8.50	10.00	69	19.0	4	8.500
9.00	10.00	69	19.0	4	9.000
9.50	10.00	69	19.0	4	9.500
10.00	10.00	72	22.0	4	10.000
11.00	12.00	79	22.0	4	11.000
12.00	12.00	83	26.0	4	12.000
13.00	12.00	83	26.0	4	13.000
14.00	12.00	83	26.0	4	14.000
15.00	12.00	83	26.0	4	15.000
16.00	16.00	92	32.0	4	16.000
18.00	16.00	92	32.0	4	18.000
20.00	20.00	104	38.0	4	20.000
22.00	20.00	104	38.0	6	22.000
24.00	25.00	121	45.0	6	24.000
25.00	25.00	121	45.0	6	25.000
26.00	25.00	121	45.0	6	26.000
28.00	25.00	121	45.0	6	28.000
30.00	25.00	121	45.0	6	30.000
32.00	32.00	133	53.0	6	32.000

End mills



Tool material	HSCo	
Surface	○	Ⓡ
Type	N	N
Shank form	B	B

P • **GUHRING NAVIGATOR**
M ○ Cutting data page 338
K •
N •
S ○
H ○ • centre cutting

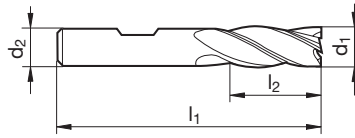

Article no. **3431** **3692**

d1 js12	d2	l1	l2	Z	Code no.
mm	mm	mm	mm		
3.00	6.00	56	12.0	4	3.000
4.00	6.00	63	19.0	4	4.000
5.00	6.00	68	24.0	4	5.000
6.00	6.00	68	24.0	4	6.000
7.00	10.00	80	30.0	4	7.000
8.00	10.00	88	38.0	4	8.000
9.00	10.00	88	38.0	4	9.000
10.00	10.00	95	45.0	4	10.000
11.00	12.00	102	45.0	4	11.000
12.00	12.00	110	53.0	4	12.000
14.00	12.00	110	53.0	4	14.000
15.00	12.00	110	53.0	4	15.000
16.00	16.00	123	63.0	4	16.000
18.00	16.00	123	63.0	4	18.000
20.00	20.00	141	75.0	4	20.000
25.00	25.00	166	90.0	6	25.000
28.00	25.00	166	90.0	6	28.000
30.00	25.00	166	90.0	6	30.000
32.00	32.00	186	106.0	6	32.000
40.00	40.00	217	125.0	6	40.000



End mills



Tool material **HSCO**

Surface ○

Type N

Shank form B

P • **GUHRING NAVIGATOR**
M ○ Cutting data page 338
K •
N •
S ○
H ○ • centre cutting

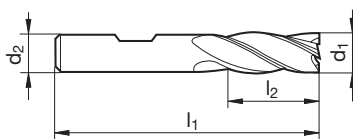

Article no. **3433**

d1 js12	d2	l1	l2	Z	Code no.
mm	mm	mm	mm		
6.00	6.00	79	40.0	4	6.000
8.00	10.00	105	56.0	4	8.000
10.00	10.00	112	63.0	4	10.000
12.00	12.00	125	71.0	4	12.000
14.00	12.00	125	71.0	4	14.000
16.00	16.00	141	80.0	4	16.000
18.00	16.00	141	80.0	4	18.000
20.00	20.00	163	100.0	4	20.000

Roughing end mills



Tool material	M42	HSCO
Surface	○	⊗
Type	NR	NR
Shank form	B	B

GUHRING NAVIGATOR
Cutting data page 338

- P** •
- M** ○
- K** •
- N** •
- S** ○
- H** ○

• centre cutting

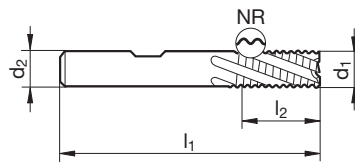

Article no. **3346** **3690**

d1 js12	d2	l1	l2	Z	Code no.
mm	mm	mm	mm		
6.00	6.00	57	13.0	4	6.000
7.00	10.00	66	16.0	4	7.000
8.00	10.00	69	19.0	4	8.000
9.00	10.00	69	19.0	4	9.000
10.00	10.00	72	22.0	4	10.000
11.00	12.00	79	22.0	4	11.000
12.00	12.00	83	26.0	4	12.000
14.00	12.00	83	26.0	4	14.000
15.00	12.00	83	26.0	4	15.000
16.00	16.00	92	32.0	4	16.000
18.00	16.00	92	32.0	4	18.000
20.00	20.00	104	38.0	4	20.000
22.00	20.00	104	38.0	4	22.000
24.00	25.00	121	45.0	4	24.000
25.00	25.00	121	45.0	4	25.000
26.00	25.00	121	45.0	4	26.000
28.00	25.00	121	45.0	4	28.000
30.00	25.00	121	45.0	4	30.000
32.00	32.00	133	53.0	4	32.000
36.00	32.00	133	53.0	6	36.000
40.00	40.00	155	63.0	6	40.000



Roughing end mills



Tool material	HSCO	
Surface	○	●
Type	NR	NR
Shank form	B	B

P ● **GUHRING NAVIGATOR**
M ○ Cutting data page 338
K ●
N ●
S ●
H ● centre cutting

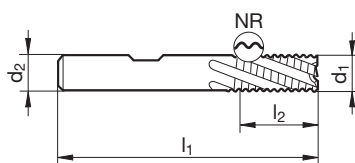

Article no. **3347** **3650**

d1 js12	d2	l1	l2	Z	Code no.
mm	mm	mm	mm		
6.00	6.00	68	24.0	4	6.000
7.00	10.00	80	30.0	4	7.000
8.00	10.00	88	38.0	4	8.000
9.00	10.00	88	38.0	4	9.000
10.00	10.00	95	45.0	4	10.000
12.00	12.00	110	53.0	4	12.000
14.00	12.00	110	53.0	4	14.000
16.00	16.00	123	63.0	4	16.000
18.00	16.00	123	63.0	4	18.000
20.00	20.00	141	75.0	4	20.000
22.00	20.00	141	75.0	4	22.000
25.00	25.00	166	90.0	4	25.000
28.00	25.00	166	90.0	4	28.000
32.00	32.00	186	106.0	4	32.000
36.00	32.00	186	106.0	6	36.000

Roughing/finishing end mills



Tool material	M42	HSCO
Surface	○	⊙
Type	NF	NF
Shank form	B	B

GUHRING NAVIGATOR
Cutting data page 338

- P** ●
- M** ○
- K** ●
- N** ●
- S** ○
- H** ○

● centre cutting

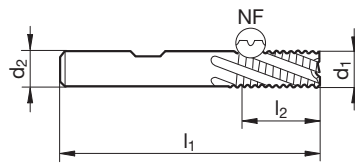

Article no. **3343** **3669**

d1 js12	d2	l1	l2	Z	Code no.
mm	mm	mm	mm		
6.00	6.00	57	13.0	4	6.000
7.00	10.00	66	16.0	4	7.000
8.00	10.00	69	19.0	4	8.000
9.00	10.00	69	19.0	4	9.000
10.00	10.00	72	22.0	4	10.000
11.00	12.00	79	22.0	4	11.000
12.00	12.00	83	26.0	4	12.000
14.00	12.00	83	26.0	4	14.000
15.00	12.00	83	26.0	4	15.000
16.00	16.00	92	32.0	4	16.000
18.00	16.00	92	32.0	4	18.000
20.00	20.00	104	38.0	4	20.000
22.00	20.00	104	38.0	4	22.000
24.00	25.00	121	45.0	4	24.000
25.00	25.00	121	45.0	4	25.000
26.00	25.00	121	45.0	4	26.000
28.00	25.00	121	45.0	4	28.000
30.00	25.00	121	45.0	4	30.000
32.00	32.00	133	53.0	4	32.000
36.00	32.00	133	53.0	6	36.000
40.00	40.00	155	63.0	6	40.000



Roughing/finishing end mills



Tool material	HSCO	
Surface	○	●
Type	NF	NF
Shank form	B	B

P ● **GUHRING NAVIGATOR**
M ○ Cutting data page 338
K ●
N ●
S ●
H ● centre cutting

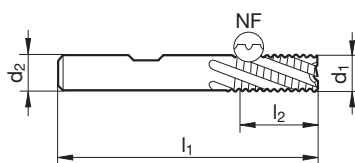

Article no. **3342** **3698**

d1 js12	d2	l1	l2	Z	Code no.
mm	mm	mm	mm		
6.00	6.00	68	24.0	4	6.000
8.00	10.00	88	38.0	4	8.000
10.00	10.00	95	45.0	4	10.000
12.00	12.00	110	53.0	4	12.000
14.00	12.00	110	53.0	4	14.000
16.00	16.00	123	63.0	4	16.000
18.00	16.00	123	63.0	4	18.000
20.00	20.00	141	75.0	4	20.000
22.00	20.00	141	75.0	4	22.000
25.00	25.00	166	90.0	4	25.000
28.00	25.00	166	90.0	4	28.000
32.00	32.00	186	106.0	4	32.000
36.00	32.00	186	106.0	6	36.000

Morse taper end mills



Tool material	HSCO
Surface	○
Type	NR
Shank form	MT

P • **GUHRING NAVIGATOR**
M ○ Cutting data page 338
K •
N •
S ○
H ○

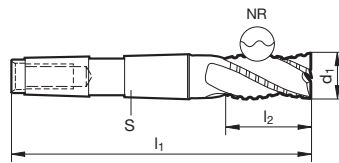

Article no. **3117**

d1 js12	S	l1	l2	Z	Code no.
mm		mm	mm		
10.00	MK-1	92	22.0	4	10.000
14.00	MK-2	111	26.0	4	14.000
16.00	MK-2	117	32.0	4	16.000
18.00	MK-2	117	32.0	4	18.000
20.00	MK-2	123	38.0	4	20.000
25.00	MK-3	147	45.0	5	25.000
26.00	MK-3	147	45.0	5	26.000
28.00	MK-3	147	45.0	5	28.000
30.00	MK-3	147	45.0	5	30.000
32.00	MK-4	201	53.0	6	32.000
40.00	MK-4	211	63.0	6	40.000
50.00	MK-5	261	75.0	8	50.000



Morse taper end mills



Tool material	HSCO
Surface	○
Type	N
Shank form	MT

P • **GUHRING NAVIGATOR**
M ○ Cutting data page 338
K •
N •
S ○
H ○

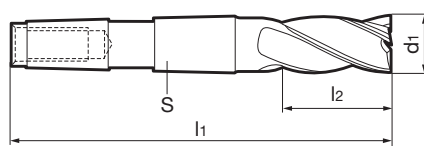

Article no. **3440**

d1 js12	S	l1	l2	Z	Code no.
mm		mm	mm		
14.00	MK-2	111	26.0	4	14.000
16.00	MK-2	117	32.0	4	16.000
18.00	MK-2	117	32.0	4	18.000
19.00	MK-2	117	32.0	4	19.000
20.00	MK-2	123	38.0	4	20.000
22.00	MK-2	123	38.0	5	22.000
25.00	MK-3	147	45.0	5	25.000
26.00	MK-3	147	45.0	5	26.000
28.00	MK-3	147	45.0	5	28.000
30.00	MK-3	147	45.0	6	30.000
32.00	MK-4	178	53.0	6	32.000
40.00	MK-4	188	63.0	6	40.000
45.00	MK-4	188	63.0	6	45.000

Morse taper end mills



Tool material	HSCO
Surface	○
Type	NR
Shank form	MT

P • **GUHRING NAVIGATOR**
M ○ Cutting data page 338
K •
N •
S ○
H ○

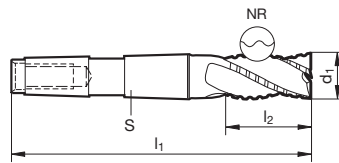

Article no. **3121**

d1 js12	S	l1	l2	Z	Code no.
mm		mm	mm		
16.00	MK-2	148	63.0	4	16.000
18.00	MK-2	148	63.0	4	18.000
20.00	MK-2	160	75.0	4	20.000
25.00	MK-3	192	90.0	5	25.000
28.00	MK-3	192	90.0	5	28.000
30.00	MK-3	192	90.0	5	30.000
32.00	MK-4	254	106.0	6	32.000
36.00	MK-4	254	106.0	6	36.000
40.00	MK-4	273	125.0	6	40.000
50.00	MK-5	336	150.0	8	50.000



Morse taper end mills

 Tool material **HSCO**

Surface ○

Type N

Shank form MT

P	•
M	○
K	•
N	•
S	•
H	•

GUHRING NAVIGATOR

Cutting data page 338

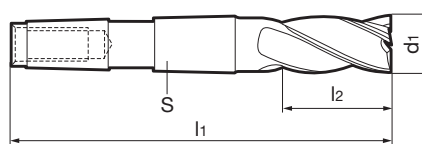

Article no.

3120

d1 js12	S	l1	l2	Z	Code no.
mm		mm	mm		
16.00	MK-2	148	63.0	4	16.000
16.00	MK-3	165	63.0	4	16.001
18.00	MK-2	148	63.0	4	18.000
18.00	MK-3	165	63.0	4	18.001
20.00	MK-2	160	75.0	4	20.000
25.00	MK-3	192	90.0	5	25.000
28.00	MK-3	192	90.0	5	28.000
28.00	MK-4	265	112.0	5	28.001
32.00	MK-4	231	106.0	6	32.000
36.00	MK-4	231	106.0	6	36.000
40.00	MK-4	250	125.0	6	40.000
40.00	MK-5	317	125.0	6	40.002
50.00	MK-5	298	112.0	6	50.001
56.00	MK-5	308	150.0	8	56.000
63.00	MK-5	411	225.0	8	63.002

Side and face cutters



Tool material	HSCO
Surface	○
Type	N
Shank form	

P • **GUHRING NAVIGATOR**
M ○ Cutting data page 338
K •
N •
S
H • cross tooth

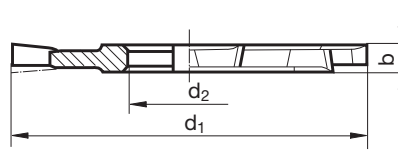

3530

d1 k14	d2	b	Z	Code no.
mm	mm	mm		
50.00	16.00	4	12	50.000
50.00	16.00	6	12	50.002
50.00	16.00	8	12	50.003
63.00	22.00	5	12	63.000
63.00	22.00	6	12	63.001
63.00	22.00	8	12	63.002
63.00	22.00	10	12	63.003
63.00	22.00	12	12	63.004
80.00	27.00	5	14	80.000
80.00	27.00	6	14	80.001
80.00	27.00	8	14	80.002
80.00	27.00	10	14	80.003
80.00	27.00	12	14	80.004
80.00	27.00	16	14	80.006
100.00	32.00	6	14	100.000
100.00	32.00	8	14	100.001
100.00	32.00	10	14	100.002
100.00	32.00	12	14	100.003
100.00	32.00	14	14	100.004
100.00	32.00	16	14	100.005
100.00	32.00	18	14	100.006
100.00	32.00	20	14	100.007
125.00	32.00	6	16	125.000
125.00	32.00	8	16	125.001
125.00	32.00	10	16	125.002
125.00	32.00	14	16	125.004
125.00	32.00	16	16	125.005
125.00	32.00	18	16	125.006
125.00	32.00	20	16	125.007
160.00	40.00	8	18	160.000
160.00	40.00	10	18	160.001
160.00	40.00	12	18	160.002
160.00	40.00	14	18	160.003
160.00	40.00	18	18	160.005
160.00	40.00	20	18	160.006



Shell end mills

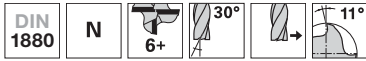

Tool material	M42	HSCO
Surface	○	⊙
Type	N	N
Shank form		

P	•	GUHRING NAVIGATOR Cutting data page 338
M	○	
K	•	
N	•	
S	•	
H		<ul style="list-style-type: none"> • face cutting • without centre cutting

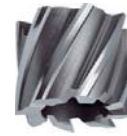
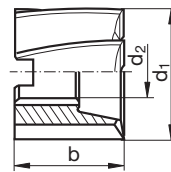

Article no. **3504** **3654**

d1 k12	d2	b	Z	Code no.
mm	mm	mm		
40.00	16.00	32	8	40.000
50.00	22.00	36	8	50.000
63.00	27.00	40	8	63.000
80.00	27.00	45	10	80.000
100.00	32.00	50	10	100.000
125.00	40.00	56	12	125.000

Shell end mills

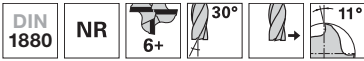

Tool material	M42	HSCO
Surface	○	⊙
Type	NR	NR
Shank form		

P • **GUHRING NAVIGATOR**
M ○ Cutting data page 338
K •
N •
S ○
H ○

- face cutting
- without centre cutting

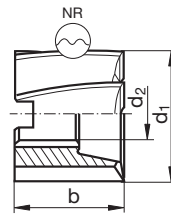

				Article no.	3185	3749
d1 k12	d2	b	Z	Code no.		
mm	mm	mm				
40.00	16.00	32	6	40.000		
50.00	22.00	36	8	50.000		
63.00	27.00	40	8	63.000		
80.00	27.00	45	10	80.000		
100.00	32.00	50	10	100.000		
125.00	40.00	56	12	125.000		



Shell end mills

 DIN
1880

NF

 Tool material **M42**

Surface ○

Type NF

Shank form

GUHRING NAVIGATOR	
P	•
M	○
K	•
N	•
S	
H	

Cutting data page 338

- face cutting
- without centre cutting

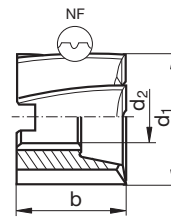

3187

d1 k12	d2	b	Z	Code no.
mm	mm	mm		
40.00	16.00	32	6	40.000
50.00	22.00	36	8	50.000
63.00	27.00	40	8	63.000
80.00	27.00	45	10	80.000
100.00	32.00	50	10	100.000
125.00	40.00	56	12	125.000

T-slot end mills

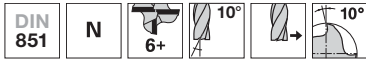

Tool material	HSCO
Surface	○
Type	N
Shank form	B

P • **GUHRING NAVIGATOR**
M ○ Cutting data page 338
K •
N •
S ○
H • cross tooth

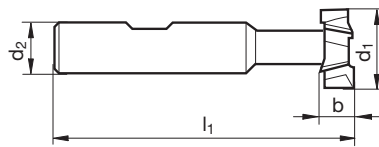

Article no. **3570**

d1	d1	d2	l1	b	Z	Code no.
	mm	mm	mm	mm		
d11	12.50	10.00	57	6.0	6	12.500
d11	16.00	10.00	62	8.0	6	16.000
d11	18.00	12.00	70	8.0	6	18.000
d11	19.00	12.00	71	9.0	6	19.000
d11	21.00	12.00	74	9.0	6	21.000
d11	22.00	12.00	75	10.0	6	22.000
d11	25.00	16.00	82	11.0	8	25.000
d11	28.00	16.00	85	12.0	8	28.000
d11	32.00	16.00	90	14.0	8	32.000



Woodruff cutters



Tool material	HSCO
Surface	○
Type	N
Shank form	B

P • **GUHRING NAVIGATOR**
M ○ Cutting data page 338
K •
N •
S ○
H ○ • cross tooth

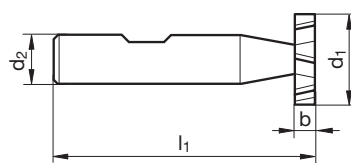

Article no. **3580**

d1	d1	d2	l1	b	Z	Code no.
	mm	mm	mm	mm		
h12	4.50	6.00	50	1.0	6	4.500
h12	7.50	6.00	50	1.5	6	7.500
h12	7.50	6.00	50	2.0	6	7.501
h12	10.50	6.00	50	2.0	6	10.500
h12	10.50	6.00	50	2.5	6	10.501
h12	10.50	6.00	50	3.0	6	10.502
h12	13.50	10.00	56	3.0	6	13.500
h12	13.50	10.00	56	4.0	6	13.501
h12	16.50	10.00	56	3.0	6	16.500
h12	16.50	10.00	56	4.0	6	16.501
h12	16.50	10.00	56	5.0	6	16.502
h12	19.50	10.00	63	4.0	8	19.500
h12	19.50	10.00	63	5.0	8	19.501
h12	19.50	10.00	63	6.0	8	19.502
h12	22.50	10.00	63	5.0	8	22.500
h12	22.50	10.00	63	6.0	8	22.501
h12	22.50	10.00	63	8.0	8	22.502
h12	25.50	10.00	63	6.0	10	25.500
h12	28.50	10.00	63	6.0	10	28.500
h12	28.50	10.00	63	8.0	10	28.501
h12	28.50	12.00	71	10.0	10	28.502
h12	32.50	12.00	71	8.0	10	32.500
h12	32.50	12.00	71	10.0	10	32.501
h12	45.50	12.00	71	10.0	12	45.500

Dovetail cutters

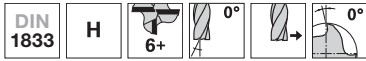

Tool material	HSCO	
Surface	○	○
Type	H	H
Shank form	B	B

P • **GUHRING NAVIGATOR**
M ○ Cutting data page 338
K •
N •
S ○
H ○ • without centre cutting

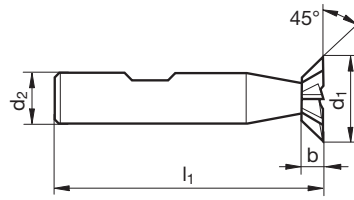

					Article no.	3572	3576
d1	d2	l1	b	Z	Code no.		
mm	mm	mm	mm				
16.00	12.00	60	4.0	10	16.000		
20.00	12.00	63	5.0	10	20.000		
25.00	12.00	67	6.3	10	25.000		
32.00	16.00	71	8.0	12	32.000		



Dovetail cutters



Tool material	HSCO	
Surface	○	○
Type	H	H
Shank form	B	B

P • **GUHRING NAVIGATOR**
M ○ Cutting data page 338
K •
N •
S ○
H ○ • without centre cutting

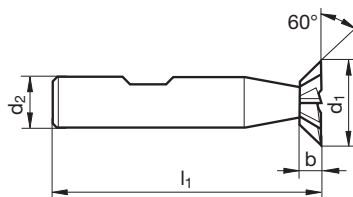

					Article no.	3574	3577
d1	d2	l1	b	Z	Code no.		
mm	mm	mm	mm				
16.00	12.00	60	6.3	10	16.000		
20.00	12.00	63	8.0	10	20.000		
25.00	12.00	67	10.0	10	25.000		
32.00	16.00	71	12.5	12	32.000		

Quadrant milling cutters

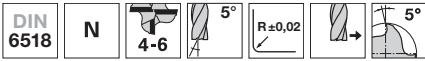

Tool material	HSCO
Surface	○
Type	N
Shank form	B

P • **GUHRING NAVIGATOR**
M ○ Cutting data page 338
K •
N •
S ○
H ○ • without centre cutting

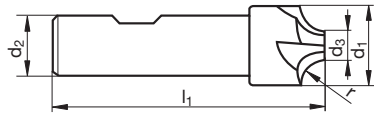

Article no. **3176**

r	d1	d2	d3	l1	Z	Code no.
mm	mm	mm	mm	mm		
2.00	10.00	10.00	6.00	60	4	2.000
2.50	10.00	10.00	6.00	60	4	2.500
3.00	12.00	12.00	6.00	60	4	3.000
4.00	14.00	12.00	6.00	60	4	4.000
5.00	16.00	12.00	6.00	60	4	5.000
6.00	20.00	16.00	8.00	67	4	6.000
8.00	24.00	16.00	8.00	71	4	8.000
10.00	28.00	25.00	8.00	85	4	10.000
12.00	35.00	25.00	16.00	90	4	12.000
16.00	48.00	25.00	16.00	100	4	16.000
20.00	58.00	32.00	20.00	112	6	20.000

powerMILL

With the **POWERMILL PROGRAMME** Guhring introduces a complete range of universal milling cutters onto the market that promises optimal performance as an all-rounder at first class prices.





NAVIGATOR CUTTING DATA TECHNICAL INFORMATION CONTENTS / ARTICLE NO. INDEX

Navigator cutting data	page 326
Technical information	page 342
Contents	page 363
Article no. index	page 387



SLOTING

Material/ISO material	Hardness	a _p max	a _e max	v _c	fz (mm/z) with nom. Ø							
					4	5	6	8	10	12	16	20
Struct./free-cutting steels, unall. heat-treat./case hard. steels	≤ 850 N/mm ²	1xD	1xD	270	0.017	0.021	0.025	0.034	0.050	0.060	0.080	0.100
P Free-cutting steels, unalloyed case hard. steels, nitr. steels	850 - 1200 N/mm ²	1xD	1xD	230	0.017	0.021	0.025	0.034	0.050	0.060	0.080	0.100
Alloyed heat-treatable, tool and high speed steels	850 - 1400 N/mm ²	1xD	1xD	180	0.014	0.018	0.021	0.028	0.045	0.054	0.072	0.090
M Stainless steel - easy to machine / sulphured	≤ 750 N/mm ²	1xD	1xD	120	0.014	0.018	0.021	0.028	0.045	0.054	0.072	0.090
Stainless steel - moderately difficult to machine	750 - 950 N/mm ²	1xD	1xD	80	0.013	0.016	0.019	0.026	0.040	0.048	0.064	0.080
K Cast iron, grey cast iron, spher. graphite/malleable cast iron	≥ 240 HB	1xD	1xD	150	0.017	0.021	0.025	0.034	0.050	0.060	0.080	0.100
N Aluminium, Al-wrought alloys, Al-alloys	≤ 7% Si	1xD	1xD	500	0.022	0.028	0.033	0.044	0.065	0.078	0.104	0.130
Aluminium-cast alloys	≥ 7% Si	1xD	1xD	340	0.018	0.023	0.027	0.036	0.055	0.066	0.088	0.110
S Titanium, Titanium alloys	≤ 1300 N/mm ²	1xD	1xD	60	0.013	0.016	0.019	0.026	0.040	0.048	0.064	0.080

HPC-ROUGHING

Material/ISO material	Hardness	a _p max	a _e max	v _c	fz (mm/z) with nom. Ø							
					4	5	6	8	10	12	16	20
Struct./free-cutting steels, unall. heat-treat./case hard. steels	≤ 850 N/mm ²	1,5xD	0,40xD	350	0.021	0.026	0.032	0.042	0.063	0.075	0.100	0.125
P Free-cutting steels, unalloyed case hard. steels, nitr. steels	850 - 1200 N/mm ²	1,5xD	0,40xD	290	0.021	0.026	0.032	0.042	0.063	0.075	0.100	0.125
Alloyed heat-treatable, tool and high speed steels	850 - 1400 N/mm ²	1,5xD	0,33xD	260	0.018	0.023	0.027	0.036	0.059	0.070	0.094	0.117
M Stainless steel - easy to machine / sulphured	≤ 750 N/mm ²	1,5xD	0,33xD	160	0.018	0.023	0.027	0.036	0.059	0.070	0.094	0.117
Stainless steel - moderately difficult to machine	750 - 950 N/mm ²	1,5xD	0,25xD	120	0.019	0.024	0.029	0.038	0.060	0.072	0.096	0.120
K Cast iron, grey cast iron, spher. graphite/malleable cast iron	≥ 240 HB	1,5xD	0,40xD	190	0.021	0.026	0.032	0.042	0.063	0.075	0.100	0.125
N Aluminium, Al-wrought alloys, Al-alloys	≤ 7% Si	1,5xD	0,40xD	600	0.028	0.034	0.041	0.055	0.081	0.098	0.130	0.163
Aluminium-cast alloys	≥ 7% Si	1,5xD	0,40xD	440	0.023	0.028	0.034	0.045	0.069	0.083	0.110	0.138
S Titanium, Titanium alloys	≤ 1300 N/mm ²	1,5xD	0,33xD	110	0.017	0.021	0.025	0.033	0.052	0.062	0.083	0.104

HSC-FINISHING

Material/ISO material	Hardness	a _p max	a _e max	v _c	fz (mm/z) with nom. Ø							
					4	5	6	8	10	12	16	20
Struct./free-cutting steels, unall. heat-treat./case hard. steels	≤ 850 N/mm ²	2xD	0,02xD	540	0.018	0.023	0.028	0.037	0.055	0.066	0.088	0.110
P Free-cutting steels, unalloyed case hard. steels, nitr. steels	850 - 1200 N/mm ²	2xD	0,02xD	460	0.018	0.023	0.028	0.037	0.055	0.066	0.088	0.110
Alloyed heat-treatable, tool and high speed steels	850 - 1400 N/mm ²	2xD	0,02xD	350	0.015	0.019	0.023	0.031	0.050	0.059	0.079	0.099
M Stainless steel - easy to machine / sulphured	≤ 750 N/mm ²	2xD	0,02xD	220	0.015	0.019	0.023	0.031	0.050	0.059	0.079	0.099
Stainless steel - moderately difficult to machine	750 - 950 N/mm ²	2xD	0,02xD	160	0.014	0.018	0.021	0.028	0.044	0.053	0.070	0.088
K Cast iron, grey cast iron, spher. graphite/malleable cast iron	≥ 240 HB	2xD	0,02xD	300	0.018	0.023	0.028	0.037	0.055	0.066	0.088	0.110
N Aluminium, Al-wrought alloys, Al-alloys	≤ 7% Si	2xD	0,02xD	1000	0.024	0.030	0.036	0.048	0.072	0.086	0.114	0.143
Aluminium-cast alloys	≥ 7% Si	2xD	0,02xD	680	0.020	0.025	0.030	0.040	0.061	0.073	0.097	0.121
S Titanium, Titanium alloys	≤ 1300 N/mm ²	2xD	0,02xD	130	0.014	0.018	0.021	0.028	0.044	0.053	0.070	0.088

RAMPING, HELIX, GROOVING

Material/ISO material	Hardness	a _p	Ramping max. angle	v _c	fz (mm/z) with nom. Ø							
					4	5	6	8	10	12	16	20
Struct./free-cutting steels, unall. heat-treat./case hard. steels	≤ 850 N/mm ²	1 x D	45°	270	0.015	0.019	0.023	0.030	0.045	0.054	0.072	0.090
P Free-cutting steels, unalloyed case hard. steels, nitr. steels	850 - 1200 N/mm ²	1 x D	45°	230	0.013	0.017	0.020	0.026	0.040	0.048	0.064	0.080
Alloyed heat-treatable, tool and high speed steels	850 - 1400 N/mm ²	1 x D	30°	180	0.011	0.014	0.017	0.022	0.030	0.036	0.048	0.060
M Stainless steel - easy to machine / sulphured	≤ 750 N/mm ²	1 x D	10°	120	0.009	0.012	0.014	0.018	0.030	0.036	0.048	0.060
Stainless steel - moderately difficult to machine	750 - 950 N/mm ²	1 x D	5°	80	0.007	0.009	0.011	0.014	0.025	0.030	0.040	0.050
K Cast iron, grey cast iron, spher. graphite/malleable cast iron	≥ 240 HB	1 x D	45°	150	0.015	0.019	0.023	0.030	0.045	0.054	0.072	0.090
N Aluminium, Al-wrought alloys, Al-alloys	≤ 7% Si	1 x D	30°	500	0.013	0.017	0.020	0.026	0.040	0.048	0.064	0.080
Aluminium-cast alloys	≥ 7% Si	1 x D	45°	340	0.015	0.019	0.023	0.030	0.045	0.054	0.072	0.090
S Titanium, Titanium alloys	≤ 1300 N/mm ²	1 x D	10°	60	0.007	0.009	0.011	0.014	0.025	0.030	0.040	0.050

DRILLING

Material/ISO material	Hardness	Drilling depth (a _p max.)	v _c	fz (mm/z) with nom. Ø							
				4	5	6	8	10	12	16	20
Struct./free-cutting steels, unall. heat-treat./case hard. steels	≤ 850 N/mm ²	1,5 x D	270	0.014	0.018	0.021	0.028	0.040	0.048	0.064	0.080
P Free-cutting steels, unalloyed case hard. steels, nitr. steels	850 - 1200 N/mm ²	1,5 x D	230	0.012	0.015	0.018	0.024	0.035	0.042	0.056	0.070
Alloyed heat-treatable, tool and high speed steels	850 - 1400 N/mm ²	1,0 x D	180	0.008	0.010	0.012	0.016	0.025	0.030	0.040	0.050
K Cast iron, grey cast iron, spher. graphite/malleable cast iron	≥ 240 HB	1,5 x D	150	0.014	0.018	0.021	0.028	0.040	0.048	0.064	0.080
N Aluminium, Al-wrought alloys, Al-alloys	≤ 7% Si	1,0 x D	500	0.012	0.015	0.018	0.024	0.035	0.042	0.056	0.070
Aluminium-cast alloys	≥ 7% Si	1,0 x D	340	0.014	0.018	0.021	0.028	0.040	0.048	0.064	0.080



6765 / 6760 - RF 100 Speed short version

SLOTING

Milling conditions	Material	Machinability	max. ap	max. ae	max. pressure angle	vc	fz (mm/z) with nom. Ø								
							3	4	5	6	8	10	12	16	20
HPC	P	light / medial difficult	0.80 x D	1.00 x D	180°	160	0.014	0.018	0.023	0.027	0.044	0.055	0.066	0.088	0.110
			0.80 x D	1.00 x D	180°	125	0.014	0.018	0.023	0.027	0.040	0.050	0.060	0.080	0.100
	M	light / medial difficult	0.80 x D	1.00 x D	180°	85	0.011	0.014	0.018	0.021	0.028	0.035	0.042	0.056	0.070
			0.80 x D	1.00 x D	180°	55	0.011	0.014	0.018	0.021	0.028	0.035	0.042	0.056	0.070
	S	medial / difficult very difficult	0.80 x D	1.00 x D	180°	45	0.011	0.014	0.018	0.021	0.028	0.035	0.042	0.056	0.070
			0.80 x D	1.00 x D	180°	30	0.009	0.012	0.015	0.018	0.024	0.030	0.036	0.048	0.060

ROUGHING

Milling conditions	Material	Machinability	max. ap	max. ae	max. pressure angle	vc	fz (mm/z) with nom. Ø								
							3	4	5	6	8	10	12	16	20
HPC	P	light / medial difficult	L2	0.20 x D	53°	270	0.022	0.029	0.036	0.043	0.070	0.088	0.106	0.141	0.176
			L2	0.20 x D	53°	210	0.022	0.029	0.036	0.043	0.064	0.080	0.096	0.128	0.160
	M	light / medial difficult	L2	0.15 x D	46°	150	0.020	0.027	0.033	0.040	0.053	0.067	0.080	0.106	0.133
			L2	0.10 x D	37°	100	0.024	0.032	0.040	0.048	0.064	0.081	0.097	0.129	0.161
	S	medial / difficult very difficult	L2	0.08 x D	31°	90	0.026	0.035	0.044	0.053	0.070	0.088	0.105	0.140	0.175
			L2	0.08 x D	31°	60	0.023	0.030	0.038	0.045	0.060	0.075	0.090	0.120	0.150

ROUGHING

Milling conditions	Material	Machinability	max. ap	max. ae	max. pressure angle	vc	fz (mm/z) with nom. Ø								
							3	4	5	6	8	10	12	16	20
HSC	P	light / medial difficult	L2	0.15 x D	46°	290	0.026	0.034	0.043	0.051	0.084	0.105	0.125	0.167	0.209
			L2	0.15 x D	46°	230	0.026	0.034	0.043	0.051	0.076	0.095	0.114	0.152	0.190
	M	light / medial difficult	L2	0.10 x D	37°	170	0.024	0.032	0.040	0.048	0.064	0.081	0.097	0.129	0.161
			L2	0.08 x D	31°	110	0.026	0.035	0.044	0.053	0.070	0.088	0.105	0.140	0.175
	S	medial / difficult very difficult	L2	0.05 x D	26°	100	0.026	0.035	0.044	0.053	0.070	0.088	0.105	0.140	0.175
			L2	0.05 x D	26°	70	0.023	0.030	0.038	0.045	0.060	0.075	0.090	0.120	0.150

FINISHING

Milling conditions	Material	Machinability	max. ap	max. ae	max. pressure angle	vc	fz (mm/z) with nom. Ø								
							3	4	5	6	8	10	12	16	20
HSC	P	light / medial difficult	L2	0.02 x D	18°	320	0.019	0.025	0.032	0.038	0.062	0.077	0.092	0.123	0.154
			L2	0.02 x D	18°	250	0.019	0.025	0.032	0.038	0.056	0.070	0.084	0.112	0.140
	M	light / medial difficult	L2	0.02 x D	18°	170	0.015	0.020	0.025	0.029	0.039	0.049	0.059	0.078	0.098
			L2	0.01 x D	11°	120	0.019	0.025	0.032	0.038	0.050	0.063	0.076	0.101	0.126
	S	medial / difficult very difficult	L2	0.01 x D	11°	100	0.019	0.025	0.032	0.038	0.050	0.063	0.076	0.101	0.126
			L2	0.01 x D	11°	70	0.016	0.022	0.027	0.032	0.043	0.054	0.065	0.086	0.108



6766 / 6761 - RF 100 Speed long

ROUGHING

Milling conditions	Material	Machinability	max. ap	max. ae	max. pressure angle	vc	fz (mm/z) with nom. Ø								
							3	4	5	6	8	10	12	16	20
HPC	P	light / medial difficult	L2	0.15 x D	46°	280	0.026	0.034	0.043	0.051	0.084	0.105	0.125	0.167	0.209
			L2	0.15 x D	46°	220	0.026	0.034	0.043	0.051	0.076	0.095	0.114	0.152	0.190
	M	light / medial difficult	L2	0.10 x D	37°	160	0.024	0.032	0.040	0.048	0.064	0.081	0.097	0.129	0.161
			L2	0.10 x D	37°	100	0.024	0.032	0.040	0.048	0.064	0.081	0.097	0.129	0.161
	S	medial / difficult very difficult	L2	0.08 x D	31°	90	0.026	0.035	0.044	0.053	0.070	0.088	0.105	0.140	0.175
			L2	0.08 x D	31°	60	0.023	0.030	0.038	0.045	0.060	0.075	0.090	0.120	0.150



ROUGHING

Milling conditions	Material	Machinability	max. ap	max. ae	max. pressure angle	vc	fz (mm/z) with nom. Ø								
							3	4	5	6	8	10	12	16	20
HSC	P	light / medial difficult	L2	0.10 x D	37°	310	0.031	0.041	0.052	0.062	0.101	0.127	0.152	0.202	0.253
			L2	0.10 x D	37°	240	0.031	0.041	0.052	0.062	0.092	0.115	0.138	0.184	0.230
	M	light / medial difficult	L2	0.08 x D	31°	170	0.026	0.035	0.044	0.053	0.070	0.088	0.105	0.140	0.175
			L2	0.08 x D	31°	110	0.026	0.035	0.044	0.053	0.070	0.088	0.105	0.140	0.175
	S	medial / difficult very difficult	L2	0.05 x D	26°	100	0.026	0.035	0.044	0.053	0.070	0.088	0.105	0.140	0.175
			L2	0.05 x D	26°	70	0.023	0.030	0.038	0.045	0.060	0.075	0.090	0.120	0.150





FINISHING

Milling conditions	Material	Machinability	max. ap	max. ae	max. pressure angle	vc	fz (mm/z) with nom. Ø								
							3	4	5	6	8	10	12	16	20
HSC	P	light / medial difficult	L2	0.01 x D	11°	340	0.024	0.032	0.041	0.049	0.079	0.099	0.119	0.158	0.198
			L2	0.01 x D	11°	270	0.024	0.032	0.041	0.049	0.072	0.090	0.108	0.144	0.180
	M	light / medial difficult	L2	0.01 x D	11°	180	0.019	0.025	0.032	0.038	0.050	0.063	0.076	0.101	0.126
			L2	0.01 x D	11°	120	0.019	0.025	0.032	0.038	0.050	0.063	0.076	0.101	0.126
	S	medial / difficult very difficult	L2	0.01 x D	11°	100	0.019	0.025	0.032	0.038	0.050	0.063	0.076	0.101	0.126
			L2	0.01 x D	11°	70	0.016	0.022	0.027	0.032	0.043	0.054	0.065	0.086	0.108

Milling conditions:

 HPC	stable machining conditions high drive power
	short tools
	long tools

Correction factors:



	ap roughing > 1.5 x D	vc -25%	fz -25%
	medium length tools	vc -30%	fz -30%
	extra length tools	vc -50%	fz -30%
	uncoated tools	vc -50%	fz -25%







Material	Hardness	RF 100 Type	Application	ae max	Vc	fz (mm/z) with nom. Ø								
						3	4	6	8	10	12	16	20	25
Struct/free-cutting steels, unall. heat-treat./case hard. steels 1.0035 S185, 1.0486 P275N, 1.0345 P235GH, 1.0050, 1.0070, 1.8937 1.0718 11SMnPb30, 1.0736 11SMn37 1.0402 C22, 1.1178 C30E 1.0503 C45, 1.1191 C30E 1.0301 C10, 1.1121 C10E 1.1750 C75W, 1.2076 102Cr6, 1.2307 29CrMoV9	≤ 850 N/mm²	U Z3	Slotting	1 x D	180	0.016	0.021	0.031	0.042	0.060	0.072	0.10	0.12	0.15
		F	Roughing	0.75 x D	210	0.018	0.024	0.036	0.048	0.069	0.083	0.11	0.14	0.17
		SF	Finishing	0.02 x D	360	0.017	0.023	0.034	0.046	0.066	0.079	0.11	0.13	0.17
Free-cutting steels, unall. case hard. steels, nitr. steels 1.0727 46 S20, 1.0728 60 S20, 1.0757 46SPb20 1.0601 C60, 1.1221 C60E 1.7043 38Cr4 1.5752 15NiCr13, 1.7131 16MnCr5, 1.7264 20CrMo5 1.8504 34CrAl6 1.8519 31CrMoV9, 1.8550 34CrAlNi7	850-1200 N/mm²	U Z4	Slotting	1 x D	160	0.014	0.019	0.029	0.038	0.055	0.066	0.09	0.11	0.14
		U Z4	Roughing	0.75 x D	190	0.017	0.022	0.033	0.044	0.063	0.076	0.10	0.13	0.16
		SF	Finishing	0.02 x D	320	0.016	0.021	0.032	0.042	0.061	0.073	0.10	0.12	0.15
Alloyed heat-treatable, tool and high speed steels 1.5131 50MnSi4, 1.7003 38Cr2, 1.7030 28Cr4 1.5710 36NiCr6, 1.7035 41Cr4, 1.7225 42CrMo4 1.2080 X210Cr12, 1.2083 X42Cr13, 1.2419 105WCr6, 1.2379 X155CrVMo12-1 1.3243 S 6-5-2-5, 1.3343 S 6-5-2, 1.3344 S 6-5-3 Spring steel = 1.5026 55Si7, 1.7176 55Cr3, 1.8159 51CrV4	850-1400 N/mm²	U Z4	Slotting	1 x D	135	0.014	0.018	0.027	0.036	0.050	0.060	0.08	0.10	0.13
		U Z4	Roughing	0.75 x D	160	0.016	0.021	0.031	0.041	0.058	0.069	0.09	0.12	0.14
		SF	Finishing	0.02 x D	270	0.015	0.020	0.030	0.040	0.055	0.066	0.09	0.11	0.14
Hardened steel Tool steel, heat-treatable steel, spring steel, high-speed steel, case hardened steel, etc. Z.B.: 1.2344 X40CrMoV5-1; 1.2767 X45NiCrMo4; 1.2379 X155CrVMo12-1; 1.2080 X210Cr12; 1.3343 S 6-5-2	≤ 54 HRC	H	Slotting	1 x D	70	0.011	0.014	0.021	0.028	0.040	0.048	0.06	0.08	0.10
		H	Roughing	0.33 x D	100	0.014	0.018	0.027	0.036	0.052	0.062	0.08	0.10	0.13
	55 - 63 HRC	H	Finishing	0.01 x D	140	0.011	0.014	0.021	0.028	0.040	0.048	0.06	0.08	0.10
		H	Slotting	1 x D	42	0.008	0.011	0.017	0.022	0.030	0.036	0.05	0.06	0.08
Stainless steel 1.4104 X14CrMoS17, 1.4105 X6CrMoS17, 1.4305 X10CrNiS18-9 USA = 303, 410, 420F, 430, 430F	≤ 750 N/mm²	VA	Slotting	1 x D	120	0.014	0.018	0.027	0.036	0.050	0.060	0.08	0.10	0.13
		VA	Roughing	0.75 x D	140	0.016	0.021	0.031	0.041	0.058	0.069	0.09	0.12	0.14
		SF	Finishing	0.02 x D	240	0.015	0.020	0.030	0.040	0.055	0.066	0.09	0.11	0.14
	750-850 N/mm²	VA / F	Slotting	1 x D	80	0.012	0.016	0.024	0.032	0.045	0.054	0.07	0.09	0.11
VA / F		Roughing	0.75 x D	100	0.014	0.018	0.028	0.037	0.052	0.062	0.08	0.10	0.13	
SF		Finishing	0.02 x D	160	0.013	0.018	0.026	0.035	0.050	0.059	0.08	0.10	0.12	
Stainless steel 1.4438 X2CrNiMo18-15-4, 1.4404 X2CrNiMo17-12-2, 1.4571 X6CrNiTi18-10 USA = 310, 316, 316B, 316L, 317	≥ 850 N/mm²	VA / F	Slotting	1 x D	60	0.011	0.014	0.021	0.028	0.040	0.048	0.06	0.08	0.10
		VA / F	Roughing	0.60 x D	80	0.013	0.017	0.025	0.034	0.048	0.058	0.08	0.10	0.12
		SF	Finishing	0.01 x D	120	0.011	0.014	0.021	0.028	0.040	0.048	0.06	0.08	0.10
Special alloys (nickel based "Ni") Nimonic, Inconel, Monel, Hastelloy	≤ 1.300 N/mm²	VA / F	Slotting	1 x D	30	0.008	0.011	0.017	0.022	0.032	0.038	0.05	0.06	0.08
		VA / F	Roughing	0.60 x D	40	0.010	0.013	0.020	0.027	0.038	0.046	0.06	0.08	0.10
		SF	Finishing	0.01 x D	60	0.008	0.011	0.017	0.022	0.032	0.038	0.05	0.06	0.08
Titanium alloys ("Ti") 3.7024 Ti99.5, 3.7114 TiAl5Sn2.5, 3.7124 TiCu2 3.7154 TiAl6Zr5, 3.7164 TiAl6V4, 3.7184 TiAl4Mo4Sn2.5	≤ 1.300 N/mm²	Ti / VA	Slotting	1 x D	60	0.012	0.016	0.024	0.032	0.045	0.054	0.07	0.09	0.11
		Ti / VA	Roughing	0.60 x D	80	0.014	0.019	0.029	0.038	0.054	0.065	0.09	0.11	0.14
		SF	Finishing	0.02 x D	120	0.013	0.018	0.026	0.035	0.050	0.059	0.08	0.10	0.12
Cast/grey cast iron, spher.graphite/mall. cast iron 0.6010 EN-GL100 (GG10), 0.6020 EN-GJL-200 (GG20), 0.7050 EN-GJS-500-7 (GGG50), 0.8535 EN-GJMW-350-4 (GTW35)	≤ 240 HB	U Z4	Slotting	1 x D	160	0.017	0.022	0.033	0.044	0.065	0.078	0.10	0.13	0.16
		U Z4	Roughing	0.75 x D	190	0.019	0.025	0.038	0.051	0.075	0.090	0.12	0.15	0.19
		SF	Finishing	0.02 x D	320	0.018	0.024	0.036	0.048	0.072	0.086	0.11	0.14	0.18
Cast/grey cast iron, spher.graphite/mall. cast iron 0.6025 EN-GL250 (GG25), 0.6035 EN-GJL-350 (GG35), 0.7070 EN-GJS-700-2 (GGG70), 0.8170 EN-GJMB-700-2 (GTS70)	≥ 240 HB	U Z4	Slotting	1 x D	140	0.015	0.020	0.030	0.040	0.055	0.066	0.09	0.11	0.14
		U Z4	Roughing	0.75 x D	170	0.017	0.023	0.035	0.046	0.063	0.076	0.10	0.13	0.16
		SF	Finishing	0.02 x D	280	0.017	0.022	0.033	0.044	0.061	0.073	0.10	0.12	0.15
Aluminium, Al-wrought alloys, Al-alloys 3.0255 Al99.5, 3.2315 AlMgSi1, 3.3515 AlMg1 3.0615 AlMgSiPb, 3.1325 AlCuMg1, 3.3245 AlMg3Si, 3.4365 AlZnMgCu1.5	≤ 7% Si	A	Slotting	1 x D	500	0.020	0.026	0.039	0.052	0.080	0.096	0.13	0.16	0.20
		A	Roughing	0.75 x D	600	0.022	0.030	0.045	0.060	0.092	0.110	0.15	0.18	0.23
		A / SF	Finishing	0.02 x D	1000	0.021	0.029	0.043	0.057	0.088	0.106	0.14	0.18	0.22
Aluminium-cast alloys 3.2131 G-AlSi5Cu1, 3.2153 G-AlSi7Cu3, 3.2573 G-AlSi9 3.2581 G-AlSi12, 3.2583 G-AlSi12Cu, - G-AlSi12CuNiMg	≥ 7% Si	A	Slotting	1 x D	230	0.017	0.022	0.033	0.044	0.060	0.072	0.10	0.12	0.15
		A	Roughing	0.75 x D	300	0.019	0.025	0.038	0.051	0.069	0.083	0.11	0.14	0.17
		A / SF	Finishing	0.02 x D	460	0.018	0.024	0.036	0.048	0.066	0.079	0.11	0.13	0.17
Magnesium-alloys MgMn2, G-MgAl8Zn1, G-MgAl6Zn3	-	A	Slotting	1 x D	180	0.015	0.020	0.030	0.040	0.055	0.066	0.09	0.11	0.14
		A	Roughing	0.75 x D	210	0.017	0.023	0.035	0.046	0.063	0.076	0.10	0.13	0.16
		A / SF	Finishing	0.02 x D	360	0.017	0.022	0.033	0.044	0.061	0.073	0.10	0.12	0.15
Non-ferr. met. (copper, short-/long-chipp. brass/bronze) 2.0070 SE-Cu, 2.1020 CuSn6, 2.1096 G-CuSn5ZnPb 2.0380 CuZn39Pb2, 2.0401 CuZn39Pb3, 2.0410 ... 2.0250 CuZn20, 2.0280 CuZn33, 2.0332 CuZn37Pb0.5 2.1090 CuSn7ZnPb, 2.1170 CuPb5Sn5, 2.1176 ... 2.0916 CuAl5, 2.0960 CuAl9Mn, 2.1050 CuSn10	≤ 850 N/mm²	A	Slotting	1 x D	250	0.017	0.022	0.033	0.044	0.060	0.072	0.10	0.12	0.15
		A	Roughing	0.75 x D	290	0.019	0.025	0.038	0.051	0.069	0.083	0.11	0.14	0.17
		A / SF	Finishing	0.02 x D	500	0.018	0.024	0.036	0.048	0.066	0.079	0.11	0.13	0.17



Milling conditions:

	unstable machining conditions low drive power
	long tools



Correction factors:

	ap roughing > 1.5 x D	vc -25%	fz -25%
	medium length tools	vc -40%	fz -40%
	extra length tools	vc -60%	fz -55%
	uncoated tools	vc -50%	fz -25%







Material	Hardness	Type	Application	ae max	Vc	fz (mm/z) with nom. Ø								
						3	4	6	8	10	12	16	20	25
Struct./free-cutting steels, unall. heat-treat./case hard. steels 1.0035 S185. 1.0486 P275N. 1.0345 P235GH. 1.0050. 1.0070. 1.8937 1.0718 11SMnPb30. 1.0736 11SMn37 1.0402 C22. 1.1178 C30E 1.0503 C45. 1.1191 C30E 1.0301 C10. 1.1121 C10E 1.1750 C75W. 1.2076 102Cr6. 1.2307 29CrMoV9	≤ 850 N/mm ²	VA / U	Slotting	1 x D	135	0.009	0.012	0.018	0.024	0.032	0.038	0.05	0.06	0.08
		VA / U	Roughing	0.75 x D	160	0.010	0.014	0.021	0.028	0.037	0.044	0.06	0.07	0.09
Free-cutting steels, unall. case hard. steels, nitr. steels 1.0727 46 S20. 1.0728 60 S20. 1.0757 46SPb20 1.0601 C60. 1.1221 C60E 1.7043 38Cr4 1.5752 15NiCr13. 1.7131 16MnCr5. 1.7264 20CrMo5 1.8504 34CrAl6 1.8519 31CrMoV9. 1.8550 34CrAlNi7	850-1200 N/mm ²	VA / U	Slotting	1 x D	120	0.009	0.012	0.018	0.024	0.032	0.038	0.05	0.06	0.08
		VA / U	Roughing	0.75 x D	140	0.010	0.014	0.021	0.028	0.037	0.044	0.06	0.07	0.09
Alloyed heat-treatable, tool and high speed steels 1.5131 50MnSi4. 1.7003 38Cr2. 1.7030 28Cr4 1.5710 36NiCr6. 1.7035 41Cr4. 1.7225 42CrMo4 1.2080 X210Cr12. 1.2083 X42Cr13. 1.2419 105WCr6. 1.2379 X155CrVMo12-1 1.3243 S 6-5-2-5. 1.3343 S 6-5-2. 1.3344 S 6-5-3 Spring steel = 1.5026 55Si7. 1.7176 55Cr3. 1.8159 51CrV4	850-1400 N/mm ²	U / F	Slotting	1 x D	100	0.008	0.011	0.017	0.022	0.030	0.036	0.05	0.06	0.08
		U / F	Roughing	0.75 x D	120	0.010	0.013	0.019	0.026	0.035	0.041	0.06	0.07	0.09
Hardened steel Tool steel, heat-treatable steel, spring steel, high-speed steel, case hardened steel, etc. Z.B.: 1.2344 X40CrMoV5-1; 1.2767 X45NiCrMo4; 1.2379 X155CrVMo12-1; 1.2080 X210Cr12; 1.3343 S 6-5-2	≤ 54 HRC	U / F	Slotting	1 x D	55	0.006	0.008	0.012	0.016	0.022	0.026	0.04	0.04	0.06
		U / F	Roughing	0.33 x D	80	0.008	0.010	0.016	0.021	0.029	0.034	0.05	0.06	0.07
	55 - 63 HRC		Slotting	1 x D	42	0.008	0.011	0.017	0.022	0.030	0.036	0.05	0.06	0.08
Stainless steel 1.4104 X14CrMoS17. 1.4105 X6CrMoS17. 1.4305 X10CrNiS18-9 USA = 303. 410. 420F. 430. 430F	≤ 750 N/mm ²	VA / U	Slotting	1 x D	90	0.008	0.011	0.017	0.022	0.030	0.036	0.05	0.06	0.08
		VA / U	Roughing	0.75 x D	110	0.010	0.013	0.019	0.026	0.035	0.041	0.06	0.07	0.09
Stainless steel 1.4301X5CrNi18-10. 1.4303 X5CrNi18-12 1.4310 XCrNi18-8 USA = 304. 304L. 420	750-850 N/mm ²	VA / U	Slotting	1 x D	65	0.008	0.010	0.015	0.020	0.028	0.034	0.04	0.06	0.07
		VA / U	Roughing	0.75 x D	80	0.009	0.012	0.017	0.023	0.032	0.039	0.05	0.06	0.08
Stainless steel 1.4438 X2CrNiMo18-15-4. 1.4404 X2CrNiMo17-12-2. 1.4571 X6CrNiTi18-10 USA = 310. 316. 316B. 316L. 317	≥ 850 N/mm ²	VA / U	Slotting	1 x D	55	0.007	0.009	0.013	0.018	0.025	0.030	0.04	0.05	0.06
		VA / U	Roughing	0.60 x D	70	0.008	0.011	0.016	0.021	0.030	0.036	0.05	0.06	0.08
Special alloys (nickel based "Ni") Nimonic. Inconel. Monel. Hastelloy	≤ 1.300 N/mm ²	VA / U	Slotting	1 x D	25	0.006	0.008	0.012	0.016	0.022	0.026	0.04	0.04	0.06
		VA / U	Roughing	0.60 x D	40	0.007	0.010	0.014	0.019	0.026	0.032	0.04	0.05	0.07
Titanium alloys ("Ti") 3.7024 Ti99.5. 3.7114 TiAl5Sn2.5. 3.7124 TiCu2 3.7154 TiAl6Zr5. 3.7164 TiAl6V4. 3.7184 TiAl4Mo4Sn2.5	≤ 1.300 N/mm ²	VA / U	Slotting	1 x D	50	0.007	0.009	0.013	0.018	0.025	0.030	0.04	0.05	0.06
		VA / U	Roughing	0.60 x D	70	0.008	0.011	0.016	0.021	0.030	0.036	0.05	0.06	0.08
Cast/grey cast iron, spher.graphite/mall. cast iron 0.6010 EN-GL100 (GG10). 0.6020 EN-GJL-200 (GG20). 0.7050 EN-GJS-500-7 (GGG50). 0.8535 EN-GJMW-350-4 (GTW35)	≤ 240 HB	U / F	Slotting	1 x D	120	0.009	0.012	0.018	0.024	0.032	0.038	0.05	0.06	0.08
		U / F	Roughing	0.75 x D	140	0.010	0.014	0.021	0.028	0.037	0.044	0.06	0.07	0.09
Cast/grey cast iron, spher.graphite/mall. cast iron 0.6025 EN-GL250 (GG25). 0.6035 EN-GJL-350 (GG35). 0.7070 EN-GJS-700-2 (GGG70). 0.8170 EN-GJMB-700-2 (GTS70)	≥ 240 HB	U / F	Slotting	1 x D	105	0.008	0.011	0.017	0.022	0.030	0.036	0.05	0.06	0.08
		U / F	Roughing	0.75 x D	130	0.010	0.013	0.019	0.026	0.035	0.041	0.06	0.07	0.09
Aluminium. Al-wrought alloys. Al-alloys 3.2055 Al99.5. 3.2315 AlMgSi1. 3.3515 AlMg1 3.0615 AlMgSiPb. 3.1325 AlCuMg1. 3.3245 AlMg3Si. 3.4365 AlZnMgCu1.5	≤ 7% Si	A / WF	Slotting	1 x D	375	0.011	0.014	0.021	0.028	0.037	0.044	0.06	0.07	0.09
		A / WF	Roughing	0.75 x D	500	0.012	0.016	0.024	0.032	0.043	0.051	0.07	0.09	0.11
Aluminium-cast alloys 3.2131 G-AlSi5Cu1. 3.2153 G-AlSi7Cu3. 3.2573 G-AlSi9 3.2581 G-AlSi12. 3.2583 G-AlSi12Cu. - G-AlSi12CuNiMg	≥ 7% Si	A / WF	Slotting	1 x D	180	0.010	0.013	0.019	0.026	0.035	0.042	0.06	0.07	0.09
		A / WF	Roughing	0.75 x D	300	0.011	0.015	0.022	0.029	0.040	0.048	0.06	0.08	0.10
Magnesium-alloys MgMn2. G-MgAl8Zn1. G-MgAl6Zn3	-	VA / A	Slotting	1 x D	140	0.010	0.013	0.019	0.026	0.035	0.042	0.06	0.07	0.09
		VA / A	Roughing	0.75 x D	170	0.011	0.015	0.022	0.029	0.040	0.048	0.06	0.08	0.10
Non-ferr. met. (copper, short-/long-chipp. brass/bronze) 2.0070 SE-Cu. 2.1020 CuSn6. 2.1096 G-CuSn5ZnPb 2.0380 CuZn39Pb2. 2.0401 CuZn39Pb3. 2.0410 ... 2.0250 CuZn20. 2.0280 CuZn33. 2.0332 CuZn37Pb0.5 2.1090 CuSn7ZnPb. 2.1170 CuPb5Sn5. 2.1176 ... 2.0916 CuAl5. 2.0960 CuAl9Mn. 2.1050 CuSn10	≤ 850 N/mm ²	VA / A	Slotting	1 x D	200	0.010	0.013	0.019	0.026	0.035	0.042	0.06	0.07	0.09
		VA / A	Roughing	0.75 x D	230	0.011	0.015	0.022	0.029	0.040	0.048	0.06	0.08	0.10

Milling conditions:

 HPC	stable machining conditions high drive power
	short tools
	long tools

Correction factors:

	ap roughing > 1.5 x D	vc -25%	fz -25%
	medium length tools	vc -40%	fz -40%
	extra length tools	vc -60%	fz -55%
	uncoated tools	vc -50%	fz -25%

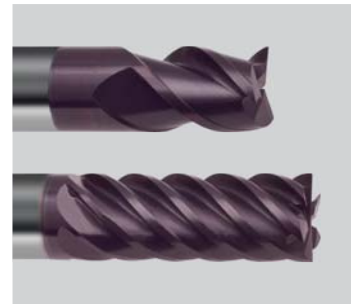

Material	Hardness	GH 100 Type	Application	ae max	Vc	fz (mm/z) with nom. Ø								
						3	4	6	8	10	12	16	20	25
Struct./free-cutting steels, unall. heat-treat./case hard. steels 1.0035 S185. 1.0486 P275N. 1.0345 P235GH. 1.0050. 1.0070. 1.8937 1.0718 11SMnPb30. 1.0736 11SMn37 1.0402 C22. 1.1178 C30E 1.0503 C45. 1.1191 C30E 1.0301 C10. 1.1121 C10E 1.1750 C75W. 1.2076 102Cr6. 1.2307 29CrMoV9	≤ 850 N/mm ²	GH Z3	Slotting	1 x D	120	0.012	0.016	0.024	0.032	0.045	0.054	0.07	0.09	0.11
		GH Z3	Roughing	0.75 x D	140	0.014	0.018	0.028	0.037	0.052	0.062	0.08	0.10	0.13
		GH Z6/8	Finishing	0.02 x D	240	0.013	0.018	0.026	0.035	0.050	0.059	0.08	0.10	0.12
Free-cutting steels, unall. case hard. steels, nitr. steels 1.0727 46 S20. 1.0728 60 S20. 1.0757 46SPb20 1.0601 C60. 1.1221 C60E 1.7043 38Cr4 1.5752 15NiCr13. 1.7131 16MnCr5. 1.7264 20CrMo5 1.8504 34CrAl6 1.8519 31CrMoV9. 1.8550 34CrAlNi7	850-1200 N/mm ²	GH Z3	Slotting	1 x D	105	0.012	0.016	0.024	0.032	0.045	0.054	0.07	0.09	0.11
		GH Z3	Roughing	0.75 x D	130	0.014	0.018	0.028	0.037	0.052	0.062	0.08	0.10	0.13
		GH Z6/8	Finishing	0.02 x D	210	0.013	0.018	0.026	0.035	0.050	0.059	0.08	0.10	0.12
Alloyed heat-treatable, tool and high speed steels 1.5131 50MnSi4. 1.7003 38Cr2. 1.7030 28Cr4 1.5710 36NiCr6. 1.7035 41Cr4. 1.7225 42CrMo4 1.2080 X210Cr12. 1.2083 X42Cr13. 1.2419 105WCr6. 1.2379 X155CrVMo12-1 1.3243 S 6-5-2-5. 1.3343 S 6-5-2. 1.3344 S 6-5-3 Spring steel = 1.5026 55Si7. 1.7176 55Cr3. 1.8159 51CrV4	850-1400 N/mm ²	GH Z3	Slotting	1 x D	90	0.011	0.015	0.023	0.030	0.042	0.050	0.07	0.08	0.11
		GH Z3	Roughing	0.75 x D	110	0.013	0.017	0.026	0.035	0.048	0.058	0.08	0.10	0.12
		GH Z6/8	Finishing	0.02 x D	180	0.013	0.017	0.025	0.033	0.046	0.055	0.07	0.09	0.12
Hardened steel Tool steel, heat-treatable steel, spring steel, high-speed steel, case hardened steel, etc. Z.B.: 1.2344 X40CrMoV5-1; 1.2767 X45NiCrMo4; 1.2379 X155CrVMo12-1; 1.2080 X210Cr12; 1.3343 S 6-5-2	≤ 54 HRC	H	Slotting	1 x D	52	0.010	0.013	0.019	0.026	0.035	0.042	0.06	0.07	0.09
		GH H Z6	Roughing	0.03 x D	100	0.024	0.032	0.048	0.064	0.088	0.105	0.14	0.18	0.22
	55 - 63 HRC	GH H Z6	Finishing	0.01 x D	110	0.010	0.013	0.019	0.026	0.035	0.042	0.06	0.07	0.09
		GH H Z6	Roughing	1 x D	35	0.008	0.010	0.015	0.020	0.028	0.034	0.04	0.06	0.07
Stainless steel 1.4104 X14CrMoS17. 1.4105 X6CrMoS17. 1.4305 X10CrNiS18-9 USA = 303. 410. 420F. 430. 430F	≤ 750 N/mm ²	GH Z3	Slotting	1 x D	80	0.011	0.015	0.023	0.030	0.042	0.050	0.07	0.08	0.11
		GH Z3	Roughing	0.75 x D	100	0.013	0.017	0.026	0.035	0.048	0.058	0.08	0.10	0.12
		GH Z6/8	Finishing	0.02 x D	160	0.013	0.017	0.025	0.033	0.046	0.055	0.07	0.09	0.12
	750-850 N/mm ²	GH Z3	Slotting	1 x D	55	0.011	0.014	0.021	0.028	0.038	0.046	0.06	0.08	0.10
GH Z3		Roughing	0.75 x D	70	0.012	0.016	0.024	0.032	0.044	0.052	0.07	0.09	0.11	
GH Z6/8		Finishing	0.02 x D	110	0.012	0.015	0.023	0.031	0.042	0.050	0.07	0.08	0.10	
Stainless steel 1.4438 X2CrNiMo18-15-4. 1.4404 X2CrNiMo17-12-2. 1.4571 X6CrNiTi18-10 USA = 310. 316. 316B. 316L. 317	≥ 850 N/mm ²	GH Z3	Slotting	1 x D	40	0.010	0.013	0.020	0.026	0.035	0.042	0.06	0.07	0.09
		GH Z3	Roughing	0.60 x D	50	0.012	0.016	0.024	0.032	0.042	0.050	0.07	0.08	0.11
		GH Z6/8	Finishing	0.01 x D	80	0.010	0.013	0.020	0.026	0.035	0.042	0.06	0.07	0.09
Special alloys (nickel based "Ni") Nimonic, Inconel, Monel, Hastelloy	≤ 1.300 N/mm ²	GH Z3	Slotting	1 x D	20	0.008	0.010	0.015	0.020	0.030	0.036	0.05	0.06	0.08
		GH Z3	Roughing	0.60 x D	30	0.009	0.012	0.018	0.024	0.036	0.043	0.06	0.07	0.09
		GH Z6/8	Finishing	0.01 x D	40	0.008	0.010	0.015	0.020	0.030	0.036	0.05	0.06	0.08
Titanium alloys ("Ti") 3.7024 Ti99.5. 3.7114 TiAl5Sn2.5. 3.7124 TiCu2 3.7154 TiAl6Zr5. 3.7164 TiAl6V4. 3.7184 TiAl4Mo4Sn2.5	≤ 1.300 N/mm ²	GH Z3	Slotting	1 x D	40	0.010	0.013	0.020	0.026	0.038	0.046	0.06	0.08	0.10
		GH Z3	Roughing	0.60 x D	50	0.012	0.016	0.024	0.032	0.046	0.055	0.07	0.09	0.11
		GH Z6/8	Finishing	0.02 x D	80	0.011	0.015	0.022	0.029	0.042	0.050	0.07	0.08	0.10
Cast/grey cast iron, spher.graphite/mall. cast iron 0.6010 EN-GL100 (GG10). 0.6020 EN-GJL-200 (GG20). 0.7050 EN-GJS-500-7 (GGG50). 0.8535 EN-GJMw-350-4 (GTW35)	≤ 240 HB	GH Z3	Slotting	1 x D	105	0.012	0.016	0.024	0.032	0.045	0.054	0.07	0.09	0.11
		GH Z3	Roughing	0.75 x D	130	0.014	0.018	0.028	0.037	0.052	0.062	0.08	0.10	0.13
		GH Z6/8	Finishing	0.02 x D	210	0.013	0.018	0.026	0.035	0.050	0.059	0.08	0.10	0.12
Cast/grey cast iron, spher.graphite/mall. cast iron 0.6025 EN-GL250 (GG25). 0.6035 EN-GJL-350 (GG35). 0.7070 EN-GJS-700-2 (GGG70). 0.8170 EN-GJMB-700-2 (GTS70)	≥ 240 HB	GH Z3	Slotting	1 x D	90	0.011	0.015	0.023	0.030	0.042	0.050	0.07	0.08	0.11
		GH Z3	Roughing	0.75 x D	110	0.013	0.017	0.026	0.035	0.048	0.058	0.08	0.10	0.12
		GH Z6/8	Finishing	0.02 x D	180	0.013	0.017	0.025	0.033	0.046	0.055	0.07	0.09	0.12
Aluminium. Al-wrought alloys. Al-alloys 3.0255 Al99.5. 3.2315 AlMgSi1. 3.3515 AlMg1 3.0615 AlMgSiPb. 3.1325 AlCuMg1. 3.3245 AlMg3Si. 3.4365 AlZnMgCu1.5	≤ 5% Si	GH Z3	Slotting	1 x D	300	0.015	0.020	0.030	0.040	0.055	0.066	0.09	0.11	0.14
		GH Z3	Roughing	0.75 x D	400	0.017	0.023	0.035	0.046	0.063	0.076	0.10	0.13	0.16
		GH Z6/8	Finishing	0.02 x D	600	0.017	0.022	0.033	0.044	0.061	0.073	0.10	0.12	0.15
Aluminium-cast alloys 3.2131 G-AlSi5Cu1. 3.2153 G-AlSi7Cu3. 3.2573 G-AlSi9 3.2581 G-AlSi12. 3.2583 G-AlSi12Cu. - G-AlSi12CuNiMg	≥ 5% Si	GH Z3	Slotting	1 x D	180	0.014	0.018	0.027	0.036	0.050	0.060	0.08	0.10	0.13
		GH Z3	Roughing	0.75 x D	300	0.016	0.021	0.031	0.041	0.058	0.069	0.09	0.12	0.14
		GH Z6/8	Finishing	0.02 x D	360	0.015	0.020	0.030	0.040	0.055	0.066	0.09	0.11	0.14
Magnesium-alloys MgMn2. G-MgAl8Zn1. G-MgAl6Zn3	-	GH Z3	Slotting	1 x D	150	0.013	0.017	0.025	0.034	0.045	0.054	0.07	0.09	0.11
		GH Z3	Roughing	0.75 x D	180	0.000	0.000	0.000	0.000	0.000	0.000	0.00	0.00	0.00
		GH Z6/8	Finishing	0.02 x D	300	0.014	0.018	0.028	0.037	0.050	0.059	0.08	0.10	0.12
Non-ferr. met. (copper, short-/long-chipp. brass/bronze) 2.0070 SE-Cu. 2.1020 CuSn6. 2.1096 G-CuSn5ZnPb 2.0380 CuZn39Pb2. 2.0401 CuZn39Pb3. 2.0410 ... 2.0250 CuZn20. 2.0280 CuZn33. 2.0332 CuZn37Pb0.5 2.1090 CuSn7ZnPb. 2.1170 CuPb5Sn5. 2.1176 ... 2.0916 CuAl5. 2.0960 CuAl9Mn. 2.1050 CuSn10	≤ 850 N/mm ²	GH Z3	Slotting	1 x D	200	0.014	0.018	0.027	0.036	0.050	0.060	0.08	0.10	0.13
		GH Z3	Roughing	0.75 x D	230	0.016	0.021	0.031	0.041	0.058	0.069	0.09	0.12	0.14
		GH Z6/8	Finishing	0.02 x D	400	0.015	0.020	0.030	0.040	0.055	0.066	0.09	0.11	0.14



Milling conditions:

	unstable machining conditions
	low drive power

Correction factors:

	a_p roughing > 1,5 x D	vc -25%	fz -25%

	long tools
--	------------

	uncoated tools	vc -50%	fz -25%
--	----------------	-----------	-----------



Material	Hardness	Application	a_e max	a_e max	V_c	fz (mm/z) with nom. Ø								
						3	4	6	8	10	12	16	20	25
Struct./free-cutting steels, unall. heat-treat./case hard. steels 1.0035 S185. 1.0486 P275N. 1.0345 P235GH. 1.0050. 1.0070. 1.8937 1.0718 11SMnPb30. 1.0736 11SMn37 1.0402 C22. 1.1178 C30E 1.0503 C45. 1.1191 C30E 1.0301 C10. 1.1121 C10E 1.1750 C75W. 1.2076 102Cr6. 1.2307 29CrMoV9	≤ 850 N/mm ²	U	Slotting	1 x D	120	0.008	0.011	0.017	0.022	0.030	0.036	0.05	0.06	0.08
		U	Roughing	0.75 x D	140	0.010	0.013	0.019	0.026	0.035	0.041	0.06	0.07	0.09
Free-cutting steels, unall. case hard. steels, nitr. steels 1.0727 46 S20. 1.0728 60 S20. 1.0757 46SPb20 1.0601 C60. 1.1221 C60E 1.7043 38Cr4 1.5752 15NiCr13. 1.7131 16MnCr5. 1.7264 20CrMo5 1.8504 34CrAl6 1.8519 31CrMoV9. 1.8550 34CrAlNi7	850-1.200 N/mm ²	U	Slotting	1 x D	100	0.008	0.011	0.017	0.022	0.030	0.036	0.05	0.06	0.08
		U	Roughing	0.75 x D	120	0.010	0.013	0.019	0.026	0.035	0.041	0.06	0.07	0.09
Alloyed heat-treatable, tool and high speed steels 1.5131 50MnSi4. 1.7003 38Cr2. 1.7030 28Cr4 1.5710 36NiCr6. 1.7035 41Cr4. 1.7225 42CrMo4 1.2080 X210Cr12. 1.2083 X42Cr13. 1.2419 105WCr6. 1.2379 X155CrVMo12-1 1.3243 S 6-5-2-5. 1.3343 S 6-5-2. 1.3344 S 6-5-3 Spring steel = 1.5026 55Si7. 1.7176 55Cr3. 1.8159 51CrV4	850-1.400 N/mm ²	H	Slotting	1 x D	90	0.008	0.010	0.015	0.020	0.028	0.034	0.04	0.06	0.07
		H	Roughing	0.75 x D	110	0.009	0.012	0.017	0.023	0.032	0.039	0.05	0.06	0.08
Hardened steel Tool steel, heat-treatable steel, spring steel, high-speed steel, case hardened steel, etc. Z.B.: 1.2344 X40CrMoV5-1; 1.2767 X45NiCrMo4; 1.2379 X155CrVMo12-1; 1.2080 X210Cr12; 1.3343 S 6-5-2	≤ 54 HRC	H	Slotting	1 x D	50	0.005	0.007	0.011	0.014	0.020	0.024	0.03	0.04	0.05
		H	Roughing	0.33 x D	70	0.007	0.009	0.014	0.019	0.026	0.031	0.04	0.05	0.07
		55 - 63 HRC		Slotting	1 x D	42	0.005	0.006	0.009	0.012	0.015	0.018	0.02	0.03
Stainless steel 1.4104 X14CrMoS17. 1.4105 X6CrMoS17. 1.4305 X10CrNiS18-9 USA = 303. 410. 420F. 430. 430F	≤ 750 N/mm ²	U	Slotting	1 x D	80	0.008	0.010	0.015	0.020	0.028	0.034	0.04	0.06	0.07
		U	Roughing	0.75 x D	100	0.009	0.012	0.017	0.023	0.032	0.039	0.05	0.06	0.08
Stainless steel 1.4301X5CrNi18-10. 1.4303 X5CrNi18-12 1.4310 XCrNi18-8 USA = 304. 304L. 420	750-850 N/mm ²	U	Slotting	1 x D	55	0.007	0.009	0.013	0.018	0.025	0.030	0.04	0.05	0.06
		U	Roughing	0.75 x D	70	0.008	0.010	0.015	0.020	0.029	0.035	0.05	0.06	0.07
Stainless steel 1.4438 X2CrNiMo18-15-4. 1.4404 X2CrNiMo17-12-2. 1.4571 X6CrNiTi18-10 USA = 310. 316. 316B. 316L. 317	≥ 850 N/mm ²	U	Slotting	1 x D	50	0.006	0.008	0.012	0.016	0.022	0.026	0.04	0.04	0.06
		U	Roughing	0.60 x D	70	0.007	0.010	0.014	0.019	0.026	0.032	0.04	0.05	0.07
Special alloys (nickel based "Ni") Nimonic. Inconel. Monel. Hastelloy	≤ 1.300 N/mm ²	U	Slotting	1 x D	20	0.005	0.007	0.011	0.014	0.020	0.024	0.03	0.04	0.05
		U	Roughing	0.60 x D	30	0.006	0.009	0.013	0.017	0.024	0.029	0.04	0.05	0.06
Titanium alloys ("Ti") 3.7024 Ti99.5. 3.7114 TiAl5Sn2.5. 3.7124 TiCu2 3.7154 TiAl6Zr5. 3.7164 TiAl6V4. 3.7184 TiAl4Mo4Sn2.5	≤ 1.300 N/mm ²	U	Slotting	1 x D	45	0.006	0.008	0.012	0.016	0.022	0.026	0.04	0.04	0.06
		U	Roughing	0.60 x D	60	0.007	0.010	0.014	0.019	0.026	0.032	0.04	0.05	0.07
Cast/grey cast iron, spher.graphite/mall. cast iron 0.6010 EN-GL100 (GG10). 0.6020 EN-GJL-200 (GG20). 0.7050 EN-GJS-500-7 (GGG50). 0.8535 EN-GJMW-350-4 (GTW35)	≤ 240 HB	U	Slotting	1 x D	100	0.008	0.011	0.017	0.022	0.030	0.036	0.05	0.06	0.08
		U	Roughing	0.75 x D	120	0.010	0.013	0.019	0.026	0.035	0.041	0.06	0.07	0.09
Cast/grey cast iron, spher.graphite/mall. cast iron 0.6025 EN-GL250 (GG25). 0.6035 EN-GJL-350 (GG35). 0.7070 EN-GJS-700-2 (GGG70). 0.8170 EN-GJMB-700-2 (GTS70)	≥ 240 HB	H	Slotting	1 x D	90	0.008	0.010	0.015	0.020	0.028	0.034	0.04	0.06	0.07
		H	Roughing	0.75 x D	110	0.009	0.012	0.017	0.023	0.032	0.039	0.05	0.06	0.08
Aluminium. Al-wrought alloys. Al-alloys 3.0255 Al99.5. 3.2315 AlMgSi1. 3.3515 AlMg1 3.0615 AlMgSiPb. 3.1325 AlCuMg1. 3.3245 AlMg3Si. 3.4365 AlZnMgCu1.5	≤ 7% Si	A	Slotting	1 x D	350	0.010	0.013	0.019	0.026	0.035	0.042	0.06	0.07	0.09
		A	Roughing	0.75 x D	410	0.011	0.015	0.022	0.029	0.040	0.048	0.06	0.08	0.10
Aluminium-cast alloys 3.2131 G-AlSi5Cu1. 3.2153 G-AlSi7Cu3. 3.2573 G-AlSi9 3.2581 G-AlSi12. 3.2583 G-AlSi12Cu. - G-AlSi12CuNiMg	≥ 7% Si	A	Slotting	1 x D	180	0.009	0.012	0.018	0.024	0.032	0.038	0.05	0.06	0.08
		A	Roughing	0.75 x D	210	0.010	0.014	0.021	0.028	0.037	0.044	0.06	0.07	0.09
Magnesium-alloys MgMn2. G-MgAl8Zn1. G-MgAl6Zn3	-	A	Slotting	1 x D	120	0.009	0.012	0.018	0.024	0.032	0.038	0.05	0.06	0.08
		A	Roughing	0.75 x D	140	0.010	0.014	0.021	0.028	0.037	0.044	0.06	0.07	0.09
Non-ferr. met. (copper, short-/long-chipp. brass/bronze) 2.0070 SE-Cu. 2.1020 CuSn6. 2.1096 G-CuSn5ZnPb 2.0380 CuZn39Pb2. 2.0401 CuZn39Pb3. 2.0410 ... 2.0250 CuZn20. 2.0280 CuZn33. 2.0332 CuZn37Pb0.5 2.1090 CuSn7ZnPb. 2.1170 CuPb5Sn5. 2.1176 ... 2.0916 CuAl5. 2.0960 CuAl9Mn. 2.1050 CuSn10	≤ 850 N/mm ²	A	Slotting	1 x D	180	0.009	0.012	0.018	0.024	0.032	0.038	0.05	0.06	0.08
		A	Roughing	0.75 x D	210	0.010	0.014	0.021	0.028	0.037	0.044	0.06	0.07	0.09

Milling

 stable machining conditions
low cutting depth, high cutting values

 short tools

 long tools

Correction factors:

 medium length tools vc -25% fz -25%

 extra length tools vc -50% fz -50%

 uncoated tools vc -50% fz -25%



Material	Hardness	Type	Application	a_p / a_e max	V_c	fz (mm/z) with nom. Ø										
						1	2	4	5	6	8	10	12	16		
Struct./free-cutting steels. unall. heat-treat./case hard. steels 1.0035 S185, 1.0486 P275N, 1.0345 P235GH, 1.0050, 1.0070, 1.8937 1.0718 11SMnPb30, 1.0736 11SMn37 1.0402 C22, 1.1178 C30E 1.0503 C45, 1.1191 C30E 1.0301 C10, 1.1121 C10E 1.1750 C75W, 1.2076 102Cr6, 1.2307 29CrMoV9	≤ 850 N/mm ²	GF500	Slotting	0.10xD	240	0.015	0.030	0.060	0.075	0.090	0.120	0.15	0.18	0.24		
		GF500	(pre-)Finishing	0.03xD	340	0.011	0.021	0.042	0.053	0.063	0.084	0.11	0.13	0.17		
		GF500	fine-finishing	0.01xD	390	0.009	0.018	0.036	0.045	0.054	0.072	0.09	0.11	0.14		
Free-cutting steels. unall. case hard. steels. nitr. steels 1.0727 46 S20, 1.0728 60 S20, 1.0757 46SPb20 1.0601 C60, 1.1221 C60E 1.7043 38Cr4 1.5752 15NiCr13, 1.7131 16MnCr5, 1.7264 20CrMo5 1.8504 34CrAl6 1.8519 31CrMoV9, 1.8550 34CrAlNi7	850-1.200 N/mm ²	GF500	Slotting	0.10xD	220	0.015	0.030	0.060	0.075	0.090	0.120	0.15	0.18	0.24		
		GF500	(pre-)Finishing	0.03xD	310	0.011	0.021	0.042	0.053	0.063	0.084	0.11	0.13	0.17		
		GF500	fine-finishing	0.02xD	350	0.010	0.020	0.039	0.049	0.059	0.078	0.10	0.12	0.16		
Alloyed heat-treatable. tool and high speed steels 1.5131 50MnSi4, 1.7003 38Cr2, 1.7030 28Cr4 1.5710 36NiCr6, 1.7035 41Cr4, 1.7225 42CrMo4 1.2080 X210Cr12, 1.2083 X42Cr13, 1.2419 105WCr6, 1.2379 X155CrVMo12-1 1.3243 S 6-5-2-5, 1.3343 S 6-5-2, 1.3344 S 6-5-3 Spring steel = 1.5026 55Si7, 1.7176 55Cr3, 1.8159 51CrV4	850-1.400 N/mm ²	GF500	Slotting	0.10xD	200	0.012	0.024	0.048	0.060	0.072	0.096	0.12	0.14	0.19		
		GF500	(pre-)Finishing	0.02xD	310	0.008	0.017	0.034	0.042	0.050	0.067	0.08	0.10	0.13		
		GF500	fine-finishing	0.02xD	320	0.008	0.016	0.031	0.039	0.047	0.062	0.08	0.09	0.12		
Hardened steel Tool steel, heat-treatable steel, spring steel, high-speed steel, case hardened steel, etc. Z.B.: 1.2344 X40CrMoV5-1; 1.2767 X45NiCrMo4; 1.2379 X155CrVMo12-1; 1.2080 X210Cr12; 1.3343 S 6-5-2	≤ 55 HRC	GF500	Slotting	0.10xD	130	0.012	0.024	0.048	0.060	0.072	0.096	0.12	0.14	0.19		
		GF500	(pre-)Finishing	0.02xD	200	0.008	0.017	0.034	0.042	0.050	0.067	0.08	0.10	0.13		
	55 - 63 HRC	GF500	fine-finishing	0.01xD	220	0.007	0.014	0.029	0.036	0.043	0.058	0.07	0.09	0.12		
		GF300	Slotting	0.10xD	90	0.010	0.020	0.040	0.050	0.060	0.080	0.10	0.12	0.16		
Stainless steel 1.4104 X14CrMoS17, 1.4105 X6CrMoS17, 1.4305 X10CrNiS18-9 USA = 303, 410, 420F, 430, 430F	≤ 750 N/mm ²	GF500	Slotting	0.10xD	160	0.013	0.026	0.052	0.065	0.078	0.104	0.13	0.16	0.21		
		GF500	(pre-)Finishing	0.03xD	230	0.009	0.018	0.036	0.046	0.055	0.073	0.09	0.11	0.15		
		GF500	fine-finishing	0.01xD	260	0.008	0.016	0.031	0.039	0.047	0.062	0.08	0.09	0.12		
	750-850 N/mm ²	GF500	Slotting	0.10xD	120	0.012	0.024	0.048	0.060	0.072	0.096	0.12	0.14	0.19		
GF500		(pre-)Finishing	0.03xD	170	0.008	0.017	0.034	0.042	0.050	0.067	0.08	0.10	0.13			
GF500		fine-finishing	0.01xD	190	0.007	0.014	0.029	0.036	0.043	0.058	0.07	0.09	0.12			
Stainless steel 1.4438 X2CrNiMo18-15-4, 1.4404 X2CrNiMo17-12-2, 1.4571 X6CrNiTi18-10 USA = 310, 316, 316B, 316L, 317	≥ 850 N/mm ²	GF500	Slotting	0.10xD	80	0.010	0.020	0.040	0.050	0.060	0.080	0.10	0.12	0.16		
		GF500	(pre-)Finishing	0.02xD	120	0.007	0.014	0.028	0.035	0.042	0.056	0.07	0.08	0.11		
		GF500	fine-finishing	0.01xD	140	0.006	0.012	0.024	0.030	0.036	0.048	0.06	0.07	0.10		
Special alloys (nickel based "Ni") Inconel, Monel, Hastelloy	≤ 1.300 N/mm ²	GF500	Slotting	0.10xD	45	0.010	0.020	0.040	0.050	0.060	0.080	0.10	0.12	0.16		
		GF500	(pre-)Finishing	0.02xD	60	0.007	0.014	0.028	0.035	0.042	0.056	0.07	0.08	0.11		
		GF500	fine-finishing	0.01xD	80	0.006	0.012	0.024	0.030	0.036	0.048	0.06	0.07	0.10		
Titanium alloys ("Ti") 3.7024 Ti99.5, 3.7114 TiAl5Sn2.5, 3.7124 TiCu2 3.7154 TiAl6Zr5, 3.7164 TiAl6V4, 3.7184 TiAl4Mo4Sn2.5	≤ 1.300 N/mm ²	GF500	Slotting	0.10xD	100	0.012	0.024	0.048	0.060	0.072	0.096	0.12	0.14	0.19		
		GF500	(pre-)Finishing	0.02xD	150	0.008	0.017	0.034	0.042	0.050	0.067	0.08	0.10	0.13		
		GF500	fine-finishing	0.01xD	170	0.007	0.014	0.029	0.036	0.043	0.058	0.07	0.09	0.12		
Cast/grey cast iron. spher.graphite/mall. cast iron 0.6010 EN-GL100 (GG10), 0.6020 EN-GJL-200 (GG20), 0.7050 EN-GJS-500-7 (GGG50), 0.8535 EN-GJMW-350-4 (GTW35)	≤ 240 HB	GF500	Slotting	0.10xD	220	0.015	0.030	0.060	0.075	0.090	0.120	0.15	0.18	0.24		
		GF500	(pre-)Finishing	0.03xD	310	0.011	0.021	0.042	0.053	0.063	0.084	0.11	0.13	0.17		
		GF500	fine-finishing	0.01xD	360	0.009	0.018	0.036	0.045	0.054	0.072	0.09	0.11	0.14		
Cast/grey cast iron. spher.graphite/mall. cast iron 0.6025 EN-GL250 (GG25), 0.6035 EN-GJL-350 (GG35), 0.7070 EN-GJS-700-2 (GGG70), 0.8170 EN-GJMB-700-2 (GTS70)	≥ 240 HB	GF300	Slotting	0.10xD	180	0.013	0.026	0.052	0.065	0.078	0.104	0.13	0.16	0.21		
		GF300	(pre-)Finishing	0.02xD	270	0.009	0.018	0.036	0.046	0.055	0.073	0.09	0.11	0.15		
		GF300	fine-finishing	0.01xD	300	0.008	0.016	0.031	0.039	0.047	0.062	0.08	0.09	0.12		
Aluminium. Al-wrought alloys. Al-alloys 3.0255 Al99.5, 3.2315 AlMgSi1, 3.3515 AlMg1 3.0615 AlMgSiPb, 3.1325 AlCuMg1, 3.3245 AlMg3Si, 3.4365 AlZnMgCu1.5	≤ 7% Si	GF500	Slotting	0.10xD	600	0.016	0.032	0.064	0.080	0.096	0.128	0.16	0.19	0.26		
		GF500	(pre-)Finishing	0.03xD	800	0.011	0.022	0.045	0.056	0.067	0.090	0.11	0.13	0.18		
		GF500	fine-finishing	0.01xD	900	0.010	0.019	0.038	0.048	0.058	0.077	0.10	0.12	0.15		
Aluminium-cast alloys 3.2131 G-AlSi5Cu1, 3.2153 G-AlSi7Cu3, 3.2573 G-AlSi9 3.2581 G-AlSi12, 3.2583 G-AlSi12Cu, - G-AlSi12CuNiMg	≥ 7% Si	GF500	Slotting	0.10xD	300	0.015	0.030	0.060	0.075	0.090	0.120	0.15	0.18	0.24		
		GF500	(pre-)Finishing	0.03xD	400	0.011	0.021	0.042	0.053	0.063	0.084	0.11	0.13	0.17		
		GF500	fine-finishing	0.01xD	500	0.009	0.018	0.036	0.045	0.054	0.072	0.09	0.11	0.14		
Magnesium-alloys MgMn2, G-MgAl8Zn1, G-MgAl6Zn3	-	GF500	Slotting	0.10xD	180	0.013	0.026	0.052	0.065	0.078	0.104	0.13	0.16	0.21		
		GF500	(pre-)Finishing	0.03xD	260	0.009	0.018	0.036	0.046	0.055	0.073	0.09	0.11	0.15		
		GF500	fine-finishing	0.01xD	290	0.008	0.016	0.031	0.039	0.047	0.062	0.08	0.09	0.12		
Non-ferr. met. (copper short-/long-chipp. brass/bronze) 2.0070 SE-Cu, 2.1020 CuSn6, 2.1096 G-CuSn5ZnPb 2.0380 CuZn39Pb2, 2.0401 CuZn39Pb3, 2.0410 ... 2.0250 CuZn20, 2.0280 CuZn33, 2.0332 CuZn37Pb0.5 2.1090 CuSn7ZnPb, 2.1170 CuPb5Sn5, 2.1176 ... 2.0916 CuAl5, 2.0960 CuAl9Mn, 2.1050 CuSn10	≤ 850 N/mm ²	GF500	Slotting	0.10xD	250	0.015	0.030	0.060	0.075	0.090	0.120	0.15	0.18	0.24		
		GF500	(pre-)Finishing	0.03xD	350	0.011	0.021	0.042	0.053	0.063	0.084	0.11	0.13	0.17		
		GF500	fine-finishing	0.01xD	400	0.009	0.018	0.036	0.045	0.054	0.072	0.09	0.11	0.14		



Milling conditions:

	stable machining conditions low cutting depth, high cutting values
--	---

	short tools
--	-------------

	long tools
--	------------

Correction factors:

	medium length tools	vc -25%	fz -25%
--	---------------------	---------	---------

	extra length tools	vc -50%	fz -50%
--	--------------------	---------	---------

	uncoated tools	vc -50%	fz -25%
--	----------------	---------	---------



Material	Hardness	Type	Application	ap max	ae max	Vc	fz (mm/z) with nom. Ø							
							1	2	4	6	8	10	12	16
Struct./free-cutting steels. unall. heat-treat./case hard. steels 1.0035 S185, 1.0486 P275N, 1.0345 P235GH, 1.0050, 1.0070, 1.8937 1.0718 11SMnPb30, 1.0736 11SMn37 1.0402 C22, 1.1178 C30E 1.0503 C45, 1.1191 C30E 1.0301 C10, 1.1121 C10E 1.1750 C75W, 1.2076 102Cr6, 1.2307 29CrMoV9	≤ 850 N/mm ²	GF500	Slotting	0.05xD	0.40xD	240	0.015	0.030	0.060	0.090	0.120	0.15	0.18	0.24
		GF500	(pre-)Finishing	0.03xD	0.25xD	340	0.011	0.021	0.042	0.063	0.084	0.11	0.13	0.17
		GF500	fine-finishing	0.01xD	0.15xD	360	0.011	0.021	0.042	0.063	0.084	0.11	0.13	0.17
Free-cutting steels. unall. case hard. steels. nitr. steels 1.0727 46 S20, 1.0728 60 S20, 1.0757 46SPb20 1.0601 C60, 1.1221 C60E 1.7043 38Cr4 1.5752 15NiCr13, 1.7131 16MnCr5, 1.7264 20CrMo5 1.8504 34CrAl6 1.8519 31CrMoV9, 1.8550 34CrAlNi7	850-1.200 N/mm ²	GF500	Slotting	0.05xD	0.40xD	220	0.015	0.030	0.060	0.090	0.120	0.15	0.18	0.24
		GF500	(pre-)Finishing	0.03xD	0.25xD	310	0.011	0.021	0.042	0.063	0.084	0.11	0.13	0.17
		GF500	fine-finishing	0.01xD	0.15xD	330	0.011	0.021	0.042	0.063	0.084	0.11	0.13	0.17
Alloyed heat-treatable. tool and high speed steels 1.5131 50MnSi4, 1.7003 38Cr2, 1.7030 28Cr4 1.5710 36NiCr6, 1.7035 41Cr4, 1.7225 42CrMo4 1.2080 X210Cr12, 1.2083 X42Cr13, 1.2419 105WCr6, 1.2379 X155CrVMo12-1 1.3243 S 6-5-2-5, 1.3343 S 6-5-2, 1.3344 S 6-5-3 Spring steel = 1.5026 55Si7, 1.7176 55Cr3, 1.8159 51CrV4	850-1.400 N/mm ²	GF500	Slotting	0.05xD	0.40xD	200	0.012	0.024	0.048	0.072	0.096	0.12	0.14	0.19
		GF500	(pre-)Finishing	0.03xD	0.25xD	280	0.008	0.017	0.034	0.050	0.067	0.08	0.10	0.13
		GF500	fine-finishing	0.01xD	0.15xD	300	0.008	0.017	0.034	0.050	0.067	0.08	0.10	0.13
Hardened steel Tool steel, heat-treatable steel, spring steel, high-speed steel, case hardened steel, etc. Z.B.: 1.2344 X40CrMoV5-1; 1.2767 X45NiCrMo4; 1.2379 X155CrVMo12-1; 1.2080 X210Cr12; 1.3343 S 6-5-2	≤ 55 HRC	GF500	Slotting	0.04xD	0.30xD	120	0.012	0.024	0.048	0.072	0.096	0.12	0.14	0.19
		GF500	(pre-)Finishing	0.03xD	0.20xD	190	0.008	0.017	0.034	0.050	0.067	0.08	0.10	0.13
	55 - 63 HRC	GF500	fine-finishing	0.01xD	0.15xD	200	0.008	0.017	0.034	0.050	0.067	0.08	0.10	0.13
		GF300	Slotting	0.03xD	0.25xD	90	0.010	0.020	0.040	0.060	0.080	0.10	0.12	0.16
Stainless steel 1.4104 X14CrMoS17, 1.4105 X6CrMoS17, 1.4305 X10CrNiS18-9 USA = 303, 410, 420F, 430, 430F	≤ 750 N/mm ²	GF500	Slotting	0.05xD	0.40xD	160	0.013	0.026	0.052	0.078	0.104	0.13	0.16	0.21
		GF500	(pre-)Finishing	0.03xD	0.25xD	230	0.009	0.018	0.036	0.055	0.073	0.09	0.11	0.15
		GF500	fine-finishing	0.01xD	0.15xD	240	0.009	0.018	0.036	0.055	0.073	0.09	0.11	0.15
	750-850 N/mm ²	GF500	Slotting	0.04xD	0.30xD	120	0.012	0.024	0.048	0.072	0.096	0.12	0.14	0.19
GF500		(pre-)Finishing	0.03xD	0.25xD	170	0.008	0.017	0.034	0.050	0.067	0.08	0.10	0.13	
GF500		fine-finishing	0.01xD	0.10xD	190	0.008	0.016	0.031	0.047	0.062	0.08	0.09	0.12	
Stainless steel 1.4438 X2CrNiMo18-15-4, 1.4404 X2CrNiMo17-12-2, 1.4571 X6CrNiTi18-10 USA = 310, 316, 316B, 316L, 317	≥ 850 N/mm ²	GF500	Slotting	0.04xD	0.25xD	80	0.010	0.020	0.040	0.060	0.080	0.10	0.12	0.16
		GF500	(pre-)Finishing	0.03xD	0.20xD	120	0.007	0.014	0.028	0.042	0.056	0.07	0.08	0.11
		GF500	fine-finishing	0.01xD	0.10xD	130	0.007	0.013	0.026	0.039	0.052	0.07	0.08	0.10
Special alloys (nickel based "Ni") Nimonic, Inconel, Monel, Hastelloy	≤ 1.300 N/mm ²	GF500	Slotting	0.04xD	0.25xD	45	0.010	0.020	0.040	0.060	0.080	0.10	0.12	0.16
		GF500	(pre-)Finishing	0.03xD	0.20xD	60	0.007	0.014	0.028	0.042	0.056	0.07	0.08	0.11
		GF500	fine-finishing	0.01xD	0.10xD	80	0.007	0.013	0.026	0.039	0.052	0.07	0.08	0.10
Titanium alloys ("Ti") 3.7024 Ti99.5, 3.7114 TiAl5Sn2.5, 3.7124 TiCu2 3.7154 TiAl6Zr5, 3.7164 TiAl6V4, 3.7184 TiAl4Mo4Sn2.5	≤ 1.300 N/mm ²	GF500	Slotting	0.05xD	0.30xD	100	0.012	0.024	0.048	0.072	0.096	0.12	0.14	0.19
		GF500	(pre-)Finishing	0.03xD	0.20xD	150	0.008	0.017	0.034	0.050	0.067	0.08	0.10	0.13
		GF500	fine-finishing	0.01xD	0.15xD	150	0.008	0.017	0.034	0.050	0.067	0.08	0.10	0.13
Cast/grey cast iron. spher.graphite/mall. cast iron 0.6010 EN-GL100 (GG10), 0.6020 EN-GJL-200 (GG20), 0.7050 EN-GJS-500-7 (GGG50), 0.8535 EN-GJMW-350-4 (GTW35)	≤ 240 HB	GF500	Slotting	0.05xD	0.40xD	220	0.015	0.030	0.060	0.090	0.120	0.15	0.18	0.24
		GF500	(pre-)Finishing	0.03xD	0.25xD	310	0.011	0.021	0.042	0.063	0.084	0.11	0.13	0.17
		GF500	fine-finishing	0.01xD	0.15xD	330	0.011	0.021	0.042	0.063	0.084	0.11	0.13	0.17
Cast/grey cast iron. spher.graphite/mall. cast iron 0.6025 EN-GL250 (GG25), 0.6035 EN-GJL-350 (GG35), 0.7070 EN-GJS-700-2 (GGG70), 0.8170 EN-GJMB-700-2 (GTS70)	≥ 240 HB	GF300	Slotting	0.05xD	0.40xD	180	0.013	0.026	0.052	0.078	0.104	0.13	0.16	0.21
		GF300	(pre-)Finishing	0.03xD	0.25xD	250	0.009	0.018	0.036	0.055	0.073	0.09	0.11	0.15
		GF300	fine-finishing	0.01xD	0.15xD	270	0.009	0.018	0.036	0.055	0.073	0.09	0.11	0.15
Aluminium. Al-wrought alloys. Al-alloys 3.0255 Al99.5, 3.2315 AlMgSi1, 3.3515 AlMg1 3.0615 AlMgSiPb, 3.1325 AlCuMg1, 3.3245 AlMg3Si, 3.4365 AlZnMgCu1.5	≤ 7% Si	GF500	Slotting	0.05xD	0.40xD	600	0.016	0.032	0.064	0.096	0.128	0.16	0.19	0.26
		GF500	(pre-)Finishing	0.03xD	0.25xD	800	0.011	0.022	0.045	0.067	0.090	0.11	0.13	0.18
		GF500	fine-finishing	0.01xD	0.15xD	900	0.011	0.022	0.045	0.067	0.090	0.11	0.13	0.18
Aluminium-cast alloys 3.2131 G-AlSi5Cu1, 3.2153 G-AlSi7Cu3, 3.2573 G-AlSi9 3.2581 G-AlSi12, 3.2583 G-AlSi12Cu, - G-AlSi12CuNiMg	≥ 7% Si	GF500	Slotting	0.05xD	0.40xD	300	0.015	0.030	0.060	0.090	0.120	0.15	0.18	0.24
		GF500	(pre-)Finishing	0.03xD	0.25xD	400	0.011	0.021	0.042	0.063	0.084	0.11	0.13	0.17
		GF500	fine-finishing	0.01xD	0.15xD	500	0.011	0.021	0.042	0.063	0.084	0.11	0.13	0.17
Magnesium-alloys MgMn2, G-MgAl8Zn1, G-MgAl6Zn3	-	GF500	Slotting	0.05xD	0.40xD	180	0.013	0.026	0.052	0.078	0.104	0.13	0.16	0.21
		GF500	(pre-)Finishing	0.03xD	0.25xD	260	0.009	0.018	0.036	0.055	0.073	0.09	0.11	0.15
		GF500	fine-finishing	0.01xD	0.15xD	270	0.009	0.018	0.036	0.055	0.073	0.09	0.11	0.15
Non-ferr. met. (copper short-/long-chipp. brass/bronze) 2.0070 SE-Cu, 2.1020 CuSn6, 2.1096 G-CuSn5ZnPb 2.0380 CuZn39Pb2, 2.0401 CuZn39Pb3, 2.0410 ... 2.0250 CuZn20, 2.0280 CuZn33, 2.0332 CuZn37Pb0.5 2.1090 CuSn7ZnPb, 2.1170 CuPb5Sn5, 2.1176 ... 2.0916 CuAl5, 2.0960 CuAl9Mn, 2.1050 CuSn10	≤ 850 N/mm ²	GF500	Slotting	0.05xD	0.40xD	250	0.015	0.030	0.060	0.090	0.120	0.15	0.18	0.24
		GF500	(pre-)Finishing	0.03xD	0.25xD	350	0.011	0.021	0.042	0.063	0.084	0.11	0.13	0.17
		GF500	fine-finishing	0.01xD	0.15xD	300	0.011	0.021	0.042	0.063	0.084	0.11	0.13	0.17

Milling conditions:

 stable machining conditions
low drive power

 long tools

Correction factors:

 extra length tools v_c -50% f_z -50%

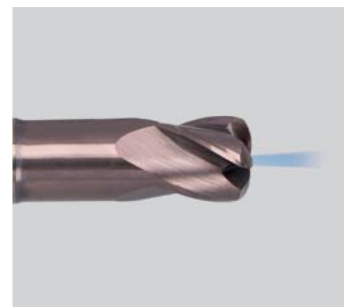

Material	Hardness	Application	a _p max	a _e max	v _c	f _z (mm/z) with nom. Ø						
						4	5	6	8	10	12	16
Struct./free-cutting steels. unall. heat-treat./case hard. steels 1.0035 S185, 1.0486 P275N, 1.0345 P235GH, 1.0050, 1.0070, 1.8937 1.0718 11SMnPb30, 1.0736 11SMn37 1.0402 C22, 1.1178 C30E 1.0503 C45, 1.1191 C30E 1.0301 C10, 1.1121 C10E 1.1750 C75W, 1.2076 102Cr6, 1.2307 29CrMoV9	≤ 850 N/mm ²	Slotting	0.04 x D	1.00 x D	200	0.140	0.175	0.240	0.320	0.40	0.48	0.64
		Roughing	0.06 x D	0.60 x D	250	0.168	0.210	0.288	0.384	0.48	0.58	0.77
		(pre-)Finishing	0.03 x D	0.40 x D	300	0.126	0.158	0.216	0.288	0.36	0.43	0.58
Free-cutting steels. unall. case hard. steels. nitr. steels 1.0727 46 S20, 1.0728 60 S20, 1.0757 46SPb20 1.0601 C60, 1.1221 C60E 1.7043 38Cr4 1.5752 15NiCr13, 1.7131 16MnCr5, 1.7264 20CrMo5 1.8504 34CrAl6 1.8519 31CrMoV9, 1.8550 34CrAlNi7	850-1200 N/mm ²	Slotting	0.04 x D	1.00 x D	170	0.120	0.150	0.210	0.280	0.35	0.42	0.56
		Roughing	0.06 x D	0.60 x D	220	0.144	0.180	0.252	0.336	0.42	0.50	0.67
		(pre-)Finishing	0.03 x D	0.40 x D	250	0.108	0.135	0.189	0.252	0.32	0.38	0.50
Alloyed heat-treatable. tool and high speed steels 1.5131 50MnSi4, 1.7003 38Cr2, 1.7030 28Cr4 1.5710 36NiCr6, 1.7035 41Cr4, 1.7225 42CrMo4 1.2080 X210Cr12, 1.2083 X42Cr13, 1.2419 105WCr6, 1.2379 X155CrVMo12-1 1.3243 S 6-5-2-5, 1.3343 S 6-5-2, 1.3344 S 6-5-3 Spring steel = 1.5026 55Si7, 1.7176 55Cr3, 1.8159 51CrV4	850-1400 N/mm ²	Slotting	0.04 x D	1.00 x D	130	0.100	0.125	0.180	0.240	0.30	0.36	0.48
		Roughing	0.05 x D	0.60 x D	170	0.120	0.150	0.216	0.288	0.36	0.43	0.58
		(pre-)Finishing	0.03 x D	0.40 x D	190	0.090	0.113	0.162	0.216	0.27	0.32	0.43
Hardened steel Tool steel, heat-treatable steel, spring steel, high-speed steel, case hardened steel, etc. Z.B.: 1.2344 X40CrMoV5-1; 1.2767 X45NiCrMo4; 1.2379 X155CrVMo12-1; 1.2080 X210Cr12; 1.3343 S 6-5-2	≤ 55 HRC	Slotting	0.03 x D	1.00 x D	100	0.080	0.100	0.150	0.200	0.25	0.30	0.40
		Roughing	0.04 x D	0.40 x D	120	0.096	0.120	0.180	0.240	0.30	0.36	0.48
		(pre-)Finishing	0.02 x D	0.30 x D	150	0.072	0.090	0.135	0.180	0.23	0.27	0.36
	55 - 63 HRC	Slotting	0.00 x D	1.00 x D	60	0.040	0.050	0.090	0.120	0.15	0.18	0.24
		Roughing	0.03 x D	0.30 x D	90	0.048	0.060	0.108	0.144	0.18	0.22	0.29
		(pre-)Finishing	0.01 x D	0.20 x D	100	0.036	0.045	0.081	0.108	0.14	0.16	0.22
Stainless steel 1.4104 X14CrMoS17, 1.4105 X6CrMoS17, 1.4305 X10CrNiS18-9 USA = 303, 410, 420F, 430, 430F	≤ 750 N/mm ²	Slotting	0.03 x D	1.00 x D	100	0.120	0.150	0.210	0.280	0.35	0.42	0.56
		Roughing	0.04 x D	0.40 x D	130	0.144	0.180	0.252	0.336	0.42	0.50	0.67
		(pre-)Finishing	0.02 x D	0.30 x D	150	0.108	0.135	0.189	0.252	0.32	0.38	0.50
Stainless steel 1.4301X5CrNi18-10, 1.4303 X5CrNi18-12 1.4310 XCrNi18-8 USA = 304, 304L, 420	750-850 N/mm ²	Slotting	0.03 x D	1.00 x D	80	0.108	0.135	0.192	0.256	0.32	0.38	0.51
		Roughing	0.04 x D	0.40 x D	100	0.130	0.162	0.230	0.307	0.38	0.46	0.61
		(pre-)Finishing	0.02 x D	0.30 x D	120	0.097	0.122	0.173	0.230	0.29	0.35	0.46
Stainless steel 1.4438 X2CrNiMo18-15-4, 1.4404 X2CrNiMo17-12-2, 1.4571 X6CrNiTi18-10 USA = 310, 316, 316B, 316L, 317	≥ 850 N/mm ²	Slotting	0.02 x D	1.00 x D	60	0.080	0.100	0.150	0.200	0.25	0.30	0.40
		Roughing	0.03 x D	0.40 x D	70	0.096	0.120	0.180	0.240	0.30	0.36	0.48
		(pre-)Finishing	0.02 x D	0.30 x D	90	0.072	0.090	0.135	0.180	0.23	0.27	0.36
Special alloys (nickel based "Ni") Inconel, Monel, Hastelloy	≤ 1.300 N/mm ²	Slotting	0.01 x D	1.00 x D	30	0.040	0.050	0.090	0.120	0.15	0.18	0.24
		Roughing	0.02 x D	0.30 x D	35	0.048	0.060	0.108	0.144	0.18	0.22	0.29
		(pre-)Finishing	0.01 x D	0.20 x D	40	0.036	0.045	0.081	0.108	0.14	0.16	0.22
Titanium alloys ("Ti") 3.7024 Ti99.5, 3.7114 TiAl5Sn2.5, 3.7124 TiCu2 3.7154 TiAl6Zr5, 3.7164 TiAl6V4, 3.7184 TiAl4Mo4Sn2.5	≤ 1.300 N/mm ²	Slotting	0.02 x D	1.00 x D	45	0.080	0.100	0.150	0.200	0.25	0.30	0.40
		Roughing	0.03 x D	0.40 x D	60	0.096	0.120	0.180	0.240	0.30	0.36	0.48
		(pre-)Finishing	0.02 x D	0.30 x D	70	0.072	0.090	0.135	0.180	0.23	0.27	0.36
Cast/grey cast iron. spher.graphite/mall. cast iron 0.6010 EN-GL100 (GG10), 0.6020 EN-GJL-200 (GG20), 0.7050 EN-GJS-500-7 (GGG50), 0.8535 EN-GJMW-350-4 (GTW35)	≤ 240 HB	Slotting	0.04 x D	1.00 x D	170	0.120	0.150	0.210	0.280	0.35	0.42	0.56
		Roughing	0.06 x D	0.60 x D	220	0.144	0.180	0.252	0.336	0.42	0.50	0.67
		(pre-)Finishing	0.03 x D	0.40 x D	250	0.108	0.135	0.189	0.252	0.32	0.38	0.50
Cast/grey cast iron. spher.graphite/mall. cast iron 0.6025 EN-GL250 (GG25), 0.6035 EN-GJL-350 (GG35), 0.7070 EN-GJS-700-2 (GGG70), 0.8170 EN-GJMB-700-2 (GTS70)	≥ 240 HB	Slotting	0.04 x D	1.00 x D	140	0.108	0.135	0.192	0.256	0.32	0.38	0.51
		Roughing	0.05 x D	0.60 x D	180	0.130	0.162	0.230	0.307	0.38	0.46	0.61
		(pre-)Finishing	0.03 x D	0.40 x D	210	0.097	0.122	0.173	0.230	0.29	0.35	0.46
Aluminium. Al-wrought alloys. Al-alloys 3.0255 Al99.5, 3.2315 AlMgSi1, 3.3515 AlMg1 3.0615 AlMgSiPb, 3.1325 AlCuMg1, 3.3245 AlMg3Si, 3.4365 AlZnMgCu1.5	≤ 7% Si											
Aluminium-cast alloys 3.2131 G-AlSi5Cu1, 3.2153 G-AlSi7Cu3, 3.2573 G-AlSi9 3.2581 G-AlSi12, 3.2583 G-AlSi12Cu, - G-AlSi12CuNiMg	≥ 7% Si											
Magnesium-alloys MgMn2, G-MgAl8Zn1, G-MgAl6Zn3	-											
Non-ferr. met. (copper. short-/long-chipp. brass/bronze) 2.0070 SE-Cu, 2.1020 CuSn6, 2.1096 G-CuSn5ZnPb 2.0380 CuZn39Pb2, 2.0401 CuZn39Pb3, 2.0410 ... 2.0250 CuZn20, 2.0280 CuZn33, 2.0332 CuZn37Pb0.5 2.1090 CuSn7ZnPb, 2.1170 CuPb5Sn5, 2.1176 ... 2.0916 CuAl5, 2.0960 CuAl9Mn, 2.1050 CuSn10	≤ 850 N/mm ²											



Milling conditions:

HPC	Stable machining conditions high drive power
	short tools
	long tools



Correction factors:

	a_p roughing > 1,5 x D	vc -25%	fz -25%
	extra length tools	vc -60%	fz -55%
	uncoated tools	vc -50%	fz -25%





Material	Hardness	Type	Application	a_e max	V_c	fz (mm/z) with nom. Ø								
						3	4	6	8	10	12	16	20	25
Struct./free-cutting steels, unall. heat-treat./case hard. steels 1.0035 S185, 1.0486 P275N, 1.0345 P235GH, 1.0050, 1.0070, 1.8937 1.0718 11SMnPb30, 1.0736 11SMn37 1.0402 C22, 1.1178 C30E 1.0503 C45, 1.1191 C30E 1.0301 C10, 1.1121 C10E 1.1750 C75W, 1.2076 102Cr6, 1.2307 29CrMoV9	≤ 850 N/mm ²	Z2 / Z3	Slotting	1 x D	120	0.012	0.016	0.024	0.032	0.042	0.050	0.07	0.08	0.11
		Z3 / Z4	Roughing	0.75 x D	140	0.014	0.018	0.028	0.037	0.048	0.058	0.08	0.10	0.12
		Z4	Finishing	0.02 x D	240	0.013	0.018	0.026	0.035	0.046	0.055	0.07	0.09	0.12
Free-cutting steels, unall. case hard. steels, nitr. steels 1.0727 46 S20, 1.0728 60 S20, 1.0757 46SPb20 1.0601 C60, 1.1221 C60E 1.7043 38Cr4 1.5752 15NiCr13, 1.7131 16MnCr5, 1.7264 20CrMo5 1.8504 34CrAl6 1.8519 31CrMoV9, 1.8550 34CrAlNi7	850-1.200 N/mm ²	Z2 / Z3	Slotting	1 x D	110	0.012	0.016	0.024	0.032	0.042	0.050	0.07	0.08	0.11
		Z3 / Z4	Roughing	0.75 x D	130	0.014	0.018	0.028	0.037	0.048	0.058	0.08	0.10	0.12
		Z4	Finishing	0.02 x D	220	0.013	0.018	0.026	0.035	0.046	0.055	0.07	0.09	0.12
Alloyed heat-treatable, tool and high speed steels 1.5131 50MnSi4, 1.7003 38Cr2, 1.7030 28Cr4 1.5710 36NiCr6, 1.7035 41Cr4, 1.7225 42CrMo4 1.2080 X210Cr12, 1.2083 X42Cr13, 1.2419 105WCr6, 1.2379 X155CrVMo12-1 1.3243 S 6-5-2-5, 1.3343 S 6-5-2, 1.3344 S 6-5-3 Spring steel = 1.5026 55Si7, 1.7176 55Cr3, 1.8159 51CrV4	850-1.400 N/mm ²	Z2 / Z3	Slotting	1 x D	90	0.011	0.014	0.021	0.028	0.039	0.047	0.06	0.08	0.10
		Z3 / Z4	Roughing	0.75 x D	110	0.012	0.016	0.024	0.032	0.045	0.054	0.07	0.09	0.11
		Z4	Finishing	0.02 x D	180	0.012	0.015	0.023	0.031	0.043	0.051	0.07	0.09	0.11
Hardened steel Tool steel, heat-treatable steel, spring steel, high-speed steel, case hardened steel, etc. Z.B.: 1.2344 X40CrMoV5-1; 1.2767 X45NiCrMo4; 1.2379 X155CrVMo12-1; 1.2080 X210Cr12; 1.3343 S 6-5-2	≤ 55 HRC	Z2 / Z3	Slotting	1 x D	35	0.007	0.009	0.013	0.018	0.024	0.029	0.04	0.05	0.06
		Z3 / Z4	Roughing	0.33 x D	50	0.009	0.011	0.017	0.023	0.031	0.037	0.05	0.06	0.08
	55 - 63 HRC	Z4	Finishing	0.01 x D	70	0.007	0.009	0.013	0.018	0.024	0.029	0.04	0.05	0.06
		H	Roughing	0.03 x D	60	0.021	0.028	0.042	0.056	0.075	0.090	0.12	0.15	0.19
Stainless steel 1.4104 X14CrMoS17, 1.4105 X6CrMoS17, 1.4305 X10CrNiS18-9 USA = 303, 410, 420F, 430, 430F	≤ 750 N/mm ²	Z2 / Z3	Slotting	1 x D	80	0.008	0.011	0.017	0.022	0.030	0.036	0.05	0.06	0.08
		Z3 / Z4	Roughing	0.75 x D	100	0.010	0.013	0.019	0.026	0.035	0.041	0.06	0.07	0.09
		Z4	Finishing	0.02 x D	160	0.009	0.012	0.018	0.025	0.033	0.040	0.05	0.07	0.08
Stainless steel 1.4301X5CrNi18-10, 1.4303 X5CrNi18-12 1.4310 XCrNi18-8 USA = 304, 304L, 420	750-850 N/mm ²	Z2 / Z3	Slotting	1 x D	55	0.007	0.010	0.014	0.019	0.027	0.032	0.04	0.05	0.07
		Z3 / Z4	Roughing	0.75 x D	70	0.008	0.011	0.017	0.022	0.031	0.037	0.05	0.06	0.08
		Z4	Finishing	0.02 x D	110	0.008	0.011	0.016	0.021	0.030	0.036	0.05	0.06	0.07
Stainless steel 1.4438 X2CrNiMo18-15-4, 1.4404 X2CrNiMo17-12-2, 1.4571 X6CrNiTi18-10 USA = 310, 316, 316B, 316L, 317	≥ 850 N/mm ²	Z2 / Z3	Slotting	1 x D	50	0.006	0.008	0.013	0.017	0.024	0.029	0.04	0.05	0.06
		Z3 / Z4	Roughing	0.60 x D	70	0.008	0.010	0.015	0.020	0.029	0.035	0.05	0.06	0.07
		Z4	Finishing	0.01 x D	100	0.006	0.008	0.013	0.017	0.024	0.029	0.04	0.05	0.06
Special alloys (nickel based "Ni") Inconel, Monel, Hastelloy	≤ 1.300 N/mm ²	Z2 / Z3	Slotting	1 x D	25	0.005	0.006	0.009	0.012	0.018	0.022	0.03	0.04	0.05
		Z3 / Z4	Roughing	0.60 x D	40	0.005	0.007	0.011	0.014	0.022	0.026	0.03	0.04	0.05
		Z4	Finishing	0.01 x D	50	0.005	0.006	0.009	0.012	0.018	0.022	0.03	0.04	0.05
Titanium alloys ("Ti") 3.7024 Ti99.5, 3.7114 TiAl5Sn2.5, 3.7124 TiCu2 3.7154 TiAl6Zr5, 3.7164 TiAl6V4, 3.7184 TiAl4Mo4Sn2.5	≤ 1.300 N/mm ²	Z2 / Z3	Slotting	1 x D	40	0.008	0.011	0.017	0.022	0.030	0.036	0.05	0.06	0.08
		Z3 / Z4	Roughing	0.60 x D	50	0.010	0.013	0.020	0.027	0.036	0.043	0.06	0.07	0.09
		Z4	Finishing	0.02 x D	80	0.009	0.012	0.018	0.025	0.033	0.040	0.05	0.07	0.08
Cast/grey cast iron, spher.graphite/mall. cast iron 0.6010 EN-GL100 (GG10), 0.6020 EN-GJL-200 (GG20), 0.7050 EN-GJS-500-7 (GGG50), 0.8535 EN-GJMw-350-4 (GTW35)	≤ 240 HB	Z2 / Z3	Slotting	1 x D	110	0.011	0.015	0.022	0.030	0.039	0.047	0.06	0.08	0.10
		Z3 / Z4	Roughing	0.75 x D	130	0.013	0.017	0.026	0.034	0.045	0.054	0.07	0.09	0.11
		Z4	Finishing	0.02 x D	220	0.012	0.016	0.024	0.033	0.043	0.051	0.07	0.09	0.11
Cast/grey cast iron, spher.graphite/mall. cast iron 0.6025 EN-GL250 (GG25), 0.6035 EN-GJL-350 (GG35), 0.7070 EN-GJS-700-2 (GGG70), 0.8170 EN-GJMB-700-2 (GTS70)	≥ 240 HB	Z2 / Z3	Slotting	1 x D	95	0.009	0.012	0.019	0.025	0.033	0.040	0.05	0.07	0.08
		Z3 / Z4	Roughing	0.75 x D	110	0.011	0.014	0.021	0.029	0.038	0.046	0.06	0.08	0.09
		Z4	Finishing	0.02 x D	190	0.010	0.014	0.020	0.027	0.036	0.044	0.06	0.07	0.09
Aluminium, Al-wrought alloys, Al-alloys 3.0255 Al99.5, 3.2315 AlMgSi1, 3.3515 AlMg1 3.0615 AlMgSiPb, 3.1325 AlCuMg1, 3.3245 AlMg3Si, 3.4365 AlZnMgCu1.5	≤ 7% Si	Z2 / Z3	Slotting	1 x D	300	0.019	0.025	0.037	0.050	0.065	0.078	0.10	0.13	0.16
		Z2 / Z3	Roughing	0.75 x D	350	0.021	0.029	0.043	0.057	0.075	0.090	0.12	0.15	0.19
		Z3 / Z4	Finishing	0.02 x D	600	0.020	0.027	0.041	0.055	0.072	0.086	0.11	0.14	0.18
Aluminium-cast alloys 3.2131 G-AlSi5Cu1, 3.2153 G-AlSi7Cu3, 3.2573 G-AlSi9 3.2581 G-AlSi12, 3.2583 G-AlSi12Cu, - G-AlSi12CuNiMg	≥ 7% Si	Z2 / Z3	Slotting	1 x D	160	0.016	0.021	0.031	0.042	0.056	0.067	0.09	0.11	0.14
		Z2 / Z3	Roughing	0.75 x D	190	0.018	0.024	0.036	0.048	0.064	0.077	0.10	0.13	0.16
		Z3 / Z4	Finishing	0.02 x D	320	0.017	0.023	0.034	0.046	0.062	0.074	0.10	0.12	0.15
Magnesium-alloys MgMn2, G-MgAl8Zn1, G-MgAl6Zn3	-	Z2 / Z3	Slotting	1 x D	125	0.016	0.021	0.031	0.042	0.056	0.067	0.09	0.11	0.14
		Z2 / Z3	Roughing	0.75 x D	210	0.018	0.024	0.036	0.048	0.064	0.077	0.10	0.13	0.16
		Z3 / Z4	Finishing	0.02 x D	360	0.017	0.023	0.034	0.046	0.062	0.074	0.10	0.12	0.15
Non-ferr. met. (copper, short-/long-chipp. brass/bronze) 2.0070 SE-Cu, 2.1020 CuSn6, 2.1096 G-CuSn5ZnPb 2.0380 CuZn39Pb2, 2.0401 CuZn39Pb3, 2.0410 ... 2.0250 CuZn20, 2.0280 CuZn33, 2.0332 CuZn37Pb0.5 2.1090 CuSn7ZnPb, 2.1170 CuPb5Sn5, 2.1176 ... 2.0916 CuAl5, 2.0960 CuAl9Mn, 2.1050 CuSn10	≤ 850 N/mm ²	Z2 / Z3	Slotting	1 x D	175	0.013	0.017	0.025	0.034	0.046	0.055	0.07	0.09	0.12
		Z2 / Z3	Roughing	0.75 x D	290	0.014	0.019	0.029	0.039	0.053	0.063	0.08	0.11	0.13
		Z3 / Z4	Finishing	0.02 x D	500	0.014	0.018	0.028	0.037	0.051	0.061	0.08	0.10	0.13

Milling conditions:

	stable machining conditions low cutting depth, high cutting values
	long tools

Correction factors:

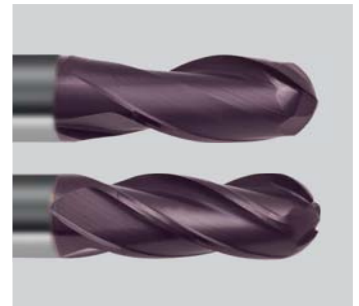

	extra length tools	vc -50%	fz -50%
	uncoated tools	vc -50%	fz -25%





Material	Hardness	Type	Application	ap / ae max	Vc	fz (mm/z) with nom. Ø								
						1	2	4	5	6	8	10	12	16
Struct./free-cutting steels. unall. heat-treat./case hard. steels 1.0035 S185, 1.0486 P275N, 1.0345 P235GH, 1.0050, 1.0070, 1.8937 1.0718 11SMnPb30, 1.0736 11SMn37 1.0402 C22, 1.1178 C30E 1.0503 C45, 1.1191 C30E 1.0301 C10, 1.1121 C10E 1.1750 C75W, 1.2076 102Cr6, 1.2307 29CrMoV9	≤ 850 N/mm ²	Z2 / Z4	Slotting	0.10 x D	175	0.004	0.008	0.016	0.020	0.025	0.034	0.04	0.05	0.07
		Z2 / Z4	(pre-)Finishing	0.03 x D	250	0.003	0.006	0.011	0.014	0.018	0.024	0.03	0.04	0.05
		Z2 / Z4	fine-finishing	0.01 x D	280	0.002	0.005	0.010	0.012	0.015	0.020	0.03	0.03	0.04
Free-cutting steels. unall. case hard. steels. nitr. steels 1.0727 46 S20, 1.0728 60 S20, 1.0757 46SPb20 1.0601 C60, 1.1221 C60E 1.7043 38Cr4 1.5752 15NiCr13, 1.7131 16MnCr5, 1.7264 20CrMo5 1.8504 34CrAl6 1.8519 31CrMoV9, 1.8550 34CrAlNi7	850-1.200 N/mm ²	Z2 / Z4	Slotting	0 x D	175	0.004	0.008	0.016	0.020	0.025	0.034	0.04	0.05	0.07
		Z2 / Z4	(pre-)Finishing	0.03 x D	250	0.003	0.006	0.011	0.014	0.018	0.024	0.03	0.04	0.05
		Z2 / Z4	fine-finishing	0.02 x D	280	0.003	0.005	0.010	0.013	0.016	0.022	0.03	0.03	0.04
Alloyed heat-treatable. tool and high speed steels 1.5131 50MnSi4, 1.7003 38Cr2, 1.7030 28Cr4 1.5710 36NiCr6, 1.7035 41Cr4, 1.7225 42CrMo4 1.2080 X210Cr12, 1.2083 X42Cr13, 1.2419 105WCr6, 1.2379 X155CrVMo12-1 1.3243 S 6-5-2-5, 1.3343 S 6-5-2, 1.3344 S 6-5-3 Spring steel = 1.5026 55Si7, 1.7176 55Cr3, 1.8159 51CrV4	850-1.400 N/mm ²	Z2 / Z4	Slotting	0 x D	140	0.004	0.008	0.015	0.019	0.024	0.032	0.04	0.05	0.06
		Z2 / Z4	(pre-)Finishing	0.02 x D	220	0.003	0.005	0.011	0.013	0.017	0.022	0.03	0.03	0.04
		Z2 / Z4	fine-finishing	0.02 x D	220	0.002	0.005	0.010	0.012	0.016	0.021	0.03	0.03	0.04
Hardened steel Tool steel. heat-treatable steel. spring steel. high-speed steel. case hardened steel. etc. Z.B.: 1.2344 X40CrMoV5-1; 1.2767 X45NiCrMo4; 1.2379 X155CrVMo12-1; 1.2080 X210Cr12; 1.3343 S 6-5-2	≤ 55 HRC													
	55 - 63 HRC													
Stainless steel 1.4104 X14CrMoS17, 1.4105 X6CrMoS17, 1.4305 X10CrNiS18-9 USA = 303, 410, 420F, 430, 430F	≤ 750 N/mm ²	Z2 / Z4	Slotting	0.10 x D	120	0.004	0.007	0.014	0.018	0.023	0.030	0.04	0.05	0.06
		Z2 / Z4	(pre-)Finishing	0.03 x D	170	0.003	0.005	0.010	0.013	0.016	0.021	0.03	0.03	0.04
		Z2 / Z4	fine-finishing	0.01 x D	190	0.002	0.004	0.009	0.011	0.014	0.018	0.02	0.03	0.04
Stainless steel 1.4301X5CrNi18-10, 1.4303 X5CrNi18-12 1.4310 XCrNi18-8 USA = 304, 304L, 420	750-850 N/mm ²	Z2 / Z4	Slotting	0.10 x D	90	0.003	0.007	0.013	0.017	0.021	0.028	0.04	0.04	0.06
		Z2 / Z4	(pre-)Finishing	0.03 x D	130	0.002	0.005	0.009	0.012	0.015	0.020	0.02	0.03	0.04
		Z2 / Z4	fine-finishing	0.01 x D	140	0.002	0.004	0.008	0.010	0.013	0.017	0.02	0.03	0.03
Stainless steel 1.4438 X2CrNiMo18-15-4, 1.4404 X2CrNiMo17-12-2, 1.4571 X6CrNiTi18-10 USA = 310, 316, 316B, 316L, 317	≥ 850 N/mm ²	Z2 / Z4	Slotting	0.10 x D	55	0.003	0.006	0.012	0.016	0.020	0.026	0.03	0.04	0.05
		Z2 / Z4	(pre-)Finishing	0.02 x D	80	0.002	0.004	0.009	0.011	0.014	0.018	0.02	0.03	0.04
		Z2 / Z4	fine-finishing	0.01 x D	100	0.002	0.004	0.007	0.009	0.012	0.016	0.02	0.02	0.03
Special alloys (nickel based "Ni") Nimonic, Inconel, Monel, Hastelloy	≤ 1.300 N/mm ²	Z2 / Z4	Slotting	0.10 x D	30	0.003	0.005	0.010	0.013	0.017	0.022	0.03	0.03	0.04
		Z2 / Z4	(pre-)Finishing	0.02 x D	40	0.002	0.004	0.007	0.009	0.012	0.016	0.02	0.02	0.03
		Z2 / Z4	fine-finishing	0.01 x D	50	0.002	0.003	0.006	0.008	0.010	0.013	0.02	0.02	0.03
Titanium alloys ("Ti") 3.7024 Ti99.5, 3.7114 TiAl5Sn2.5, 3.7124 TiCu2 3.7154 TiAl6Zr5, 3.7164 TiAl6V4, 3.7184 TiAl4Mo4Sn2.5	≤ 1.300 N/mm ²	Z2 / Z4	Slotting	0.10 x D	55	0.004	0.007	0.014	0.018	0.023	0.030	0.04	0.05	0.06
		Z2 / Z4	(pre-)Finishing	0.02 x D	80	0.003	0.005	0.010	0.013	0.016	0.021	0.03	0.03	0.04
		Z2 / Z4	fine-finishing	0.01 x D	100	0.002	0.004	0.009	0.011	0.014	0.018	0.02	0.03	0.04
Cast/grey cast iron. spher.graphite/mall. cast iron 0.6010 EN-GL100 (GG10), 0.6020 EN-GJL-200 (GG20), 0.7050 EN-GJS-500-7 (GGG50), 0.8535 EN-GJMw-350-4 (GTW35)	≤ 240 HB	Z2 / Z4	Slotting	0.10 x D	140	0.004	0.008	0.016	0.020	0.025	0.034	0.04	0.05	0.07
		Z2 / Z4	(pre-)Finishing	0.03 x D	200	0.003	0.006	0.011	0.014	0.018	0.024	0.03	0.04	0.05
		Z2 / Z4	fine-finishing	0.01 x D	230	0.002	0.005	0.010	0.012	0.015	0.020	0.03	0.03	0.04
Cast/grey cast iron. spher.graphite/mall. cast iron 0.6025 EN-GL250 (GG25), 0.6035 EN-GJL-350 (GG35), 0.7070 EN-GJS-700-2 (GGG70), 0.8170 EN-GJMB-700-2 (GTS70)	≥ 240 HB	Z2 / Z4	Slotting	0.10 x D	110	0.004	0.008	0.015	0.019	0.024	0.032	0.04	0.05	0.06
		Z2 / Z4	(pre-)Finishing	0.02 x D	170	0.003	0.005	0.011	0.013	0.017	0.022	0.03	0.03	0.04
		Z2 / Z4	fine-finishing	0.01 x D	190	0.002	0.005	0.009	0.011	0.014	0.019	0.02	0.03	0.04
Aluminium. Al-wrought alloys. Al-alloys 3.0255 Al99.5, 3.2315 AlMgSi1, 3.3515 AlMg1 3.0615 AlMgSiPb, 3.1325 AlCuMg1, 3.3245 AlMg3Si, 3.4365 AlZnMgCu1.5	≤ 7% Si													
Aluminium-cast alloys 3.2131 G-AlSi5Cu1, 3.2153 G-AlSi7Cu3, 3.2573 G-AlSi9 3.2581 G-AlSi12, 3.2583 G-AlSi12Cu, - G-AlSi12CuNiMg	≥ 7% Si	Z2 / Z4	Slotting	0.10 x D	200	0.005	0.010	0.019	0.024	0.030	0.040	0.05	0.06	0.08
		Z2 / Z4	(pre-)Finishing	0.03 x D	280	0.003	0.007	0.013	0.017	0.021	0.028	0.04	0.04	0.06
		Z2 / Z4	fine-finishing	0.01 x D	400	0.003	0.006	0.012	0.014	0.018	0.024	0.03	0.04	0.05
Magnesium-alloys MgMn2, G-MgAl8Zn1, G-MgAl6Zn3	-													
Non-ferr. met. (copper. short-/long-chipp. brass/bronze) 2.0070 SE-Cu, 2.1020 CuSn6, 2.1096 G-CuSn5ZnPb 2.0380 CuZn39Pb2, 2.0401 CuZn39Pb3, 2.0410 ... 2.0250 CuZn20, 2.0280 CuZn33, 2.0332 CuZn37Pb0.5 2.1090 CuSn7ZnPb, 2.1170 CuPb5Sn5, 2.1176 ... 2.0916 CuAl5, 2.0960 CuAl9Mn, 2.1050 CuSn10	≤ 850 N/mm ²	Z2 / Z4	Slotting	0.10 x D	175	0.004	0.008	0.015	0.019	0.024	0.032	0.04	0.05	0.06
		Z2 / Z4	(pre-)Finishing	0.03 x D	250	0.003	0.005	0.011	0.013	0.017	0.022	0.03	0.03	0.04
		Z2 / Z4	fine-finishing	0.01 x D	200	0.002	0.005	0.009	0.011	0.014	0.019	0.02	0.03	0.04



Milling conditions:

	stable machining conditions high drive power
	long tools



Correction factors:

	ap roughing > 1,5 x D	vc -25%	fz -25%
	medium length tools	vc -40%	fz -40%
	uncoated tools	vc -50%	fz -25%







Material	Hardness	Application	ae max	vc	fz (mm/z) with nom. Ø								
					3	4	6	8	10	12	16	20	25
Struct./free-cutting steels, unall. heat-treat./case hard. steels 1.0035 S185. 1.0486 P275N. 1.0345 P235GH. 1.0050. 1.0070. 1.8937 1.0718 11SMnPb30. 1.0736 11SMn37 1.0402 C22. 1.1178 C30E 1.0503 C45. 1.1191 C30E 1.0301 C10. 1.1121 C10E 1.1750 C75W. 1.2076 102Cr6. 1.2307 29CrMoV9	≤ 850 N/mm²	Slotting	1 x D	60	0.013	0.017	0.025	0.034	0.045	0.054	0.07	0.09	0.11
		Roughing	0.75 x D	70	0.014	0.019	0.029	0.039	0.052	0.062	0.08	0.10	0.13
		Finishing	0.02 x D	120	0.014	0.018	0.028	0.037	0.050	0.059	0.08	0.10	0.12
Free-cutting steels, unall. case hard. steels, nitr. steels 1.0727 46 S20. 1.0728 60 S20. 1.0757 46SPb20 1.0601 C60. 1.1221 C60E 1.7043 38Cr4 1.5752 15NiCr13. 1.7131 16MnCr5. 1.7264 20CrMo5 1.8504 34CrAl6 1.8519 31CrMoV9. 1.8550 34CrAlNi7	850-1.200 N/mm²	Slotting	1 x D	55	0.013	0.017	0.025	0.034	0.045	0.054	0.07	0.09	0.11
		Roughing	0.75 x D	65	0.014	0.019	0.029	0.039	0.052	0.062	0.08	0.10	0.13
		Finishing	0.02 x D	100	0.014	0.018	0.028	0.037	0.050	0.059	0.08	0.10	0.12
Alloyed heat-treatable, tool and high speed steels 1.5131 50MnSi4. 1.7003 38Cr2. 1.7030 28Cr4 1.5710 36NiCr6. 1.7035 41Cr4. 1.7225 42CrMo4 1.2080 X210Cr12. 1.2083 X42Cr13. 1.2419 105WCr6. 1.2379 X155CrVMo12-1 1.3243 S 6-5-2-5. 1.3343 S 6-5-2. 1.3344 S 6-5-3 Spring steel = 1.5026 55Si7. 1.7176 55Cr3. 1.8159 51CrV4	850-1.400 N/mm²	Slotting	1 x D	50	0.011	0.015	0.023	0.030	0.040	0.048	0.06	0.08	0.10
		Roughing	0.75 x D	60	0.013	0.017	0.026	0.035	0.046	0.055	0.07	0.09	0.12
		Finishing	0.02 x D	90	0.013	0.017	0.025	0.033	0.044	0.053	0.07	0.09	0.11
Hardened steel Tool steel, heat-treatable steel, spring steel, high-speed steel, case hardened steel, etc. Z.B.: 1.2344 X40CrMoV5-1; 1.2767 X45NiCrMo4; 1.2379 X155CrVMo12-1; 1.2080 X210Cr12; 1.3343 S 6-5-2	≤ 55 HRC	Slotting	1 x D	15	0.008	0.011	0.017	0.022	0.030	0.036	0.05	0.06	0.08
		Roughing	0.33 x D	20	0.011	0.015	0.022	0.029	0.039	0.047	0.06	0.08	0.10
		Finishing	0.01 x D	30	0.008	0.011	0.017	0.022	0.030	0.036	0.05	0.06	0.08
	55 - 63 HRC	Slotting	1 x D	42	0.008	0.011	0.017	0.022	0.030	0.036	0.05	0.06	0.08
		Roughing	0.03 x D	80	0.021	0.028	0.042	0.056	0.075	0.090	0.12	0.15	0.19
		Finishing	0.005 x D	100	0.008	0.010	0.015	0.020	0.027	0.032	0.04	0.05	0.07
Stainless steel 1.4104 X14CrMoS17. 1.4105 X6CrMoS17. 1.4305 X10CrNiS18-9 USA = 303. 410. 420F. 430. 430F	≤ 750 N/mm²	Slotting	1 x D	50	0.010	0.013	0.020	0.026	0.035	0.042	0.06	0.07	0.09
		Roughing	0.75 x D	60	0.011	0.015	0.023	0.030	0.040	0.048	0.06	0.08	0.10
		Finishing	0.02 x D	90	0.011	0.015	0.022	0.029	0.039	0.046	0.06	0.08	0.10
Stainless steel 1.4301X5CrNi18-10. 1.4303 X5CrNi18-12 1.4310 XCrNi18-8 USA = 304. 304L. 420	750-850 N/mm²	Slotting	1 x D	40	0.008	0.011	0.017	0.022	0.030	0.036	0.05	0.06	0.08
		Roughing	0.75 x D	50	0.010	0.013	0.019	0.026	0.035	0.041	0.06	0.07	0.09
		Finishing	0.02 x D	70	0.009	0.012	0.018	0.025	0.033	0.040	0.05	0.07	0.08
Stainless steel 1.4438 X2CrNiMo18-15-4. 1.4404 X2CrNiMo17-12-2. 1.4571 X6CrNiTi18-10 USA = 310. 316. 316B. 316L. 317	≥ 850 N/mm²	Slotting	1 x D	30	0.008	0.010	0.015	0.020	0.027	0.032	0.04	0.05	0.07
		Roughing	0.60 x D	40	0.009	0.012	0.018	0.024	0.032	0.039	0.05	0.06	0.08
		Finishing	0.01 x D	50	0.008	0.010	0.015	0.020	0.027	0.032	0.04	0.05	0.07
Special alloys (nickel based "Ni") Nimonic. Inconel. Monel. Hastelloy	≤ 1.300 N/mm²	Slotting	1 x D	10	0.007	0.009	0.013	0.018	0.024	0.029	0.04	0.05	0.06
		Roughing	0.60 x D	15	0.008	0.011	0.016	0.021	0.029	0.035	0.05	0.06	0.07
		Finishing	0.01 x D	20	0.007	0.009	0.013	0.018	0.024	0.029	0.04	0.05	0.06
Titanium alloys ("Ti") 3.7024 Ti99.5. 3.7114 TiAl5Sn2.5. 3.7124 TiCu2 3.7154 TiAl6Zr5. 3.7164 TiAl6V4. 3.7184 TiAl4Mo4Sn2.5	≤ 1.300 N/mm²	Slotting	1 x D	25	0.010	0.013	0.020	0.026	0.035	0.042	0.06	0.07	0.09
		Roughing	0.60 x D	40	0.012	0.016	0.024	0.032	0.042	0.050	0.07	0.08	0.11
		Finishing	0.02 x D	50	0.011	0.015	0.022	0.029	0.039	0.046	0.06	0.08	0.10
Cast/grey cast iron, spher.graphite/mall. cast iron 0.6010 EN-GL100 (GG10). 0.6020 EN-GJL-200 (GG20). 0.7050 EN-GJS-500-7 (GGG50). 0.8535 EN-GJMw-350-4 (GTW35)	≤ 240 HB	Slotting	1 x D	50	0.013	0.017	0.025	0.034	0.045	0.054	0.07	0.09	0.11
		Roughing	0.75 x D	60	0.014	0.019	0.029	0.039	0.052	0.062	0.08	0.10	0.13
		Finishing	0.02 x D	90	0.014	0.018	0.028	0.037	0.050	0.059	0.08	0.10	0.12
Cast/grey cast iron, spher.graphite/mall. cast iron 0.6025 EN-GL250 (GG25). 0.6035 EN-GJL-350 (GG35). 0.7070 EN-GJS-700-2 (GGG70). 0.8170 EN-GJMB-700-2 (GTS70)	≥ 240 HB	Slotting	1 x D	40	0.011	0.015	0.023	0.030	0.040	0.048	0.06	0.08	0.10
		Roughing	0.75 x D	50	0.013	0.017	0.026	0.035	0.046	0.055	0.07	0.09	0.12
		Finishing	0.02 x D	70	0.013	0.017	0.025	0.033	0.044	0.053	0.07	0.09	0.11
Aluminium. Al-wrought alloys. Al-alloys 3.0255 Al99.5. 3.2315 AlMgSi1. 3.3515 AlMg1 3.0615 AlMgSiPb. 3.1325 AlCuMg1. 3.3245 AlMg3Si. 3.4365 AlZnMgCu1.5	≤ 7% Si	Slotting	1 x D	120	0.017	0.023	0.035	0.046	0.060	0.072	0.10	0.12	0.15
		Roughing	0.75 x D	140	0.020	0.027	0.040	0.053	0.069	0.083	0.11	0.14	0.17
		Finishing	0.02 x D	240	0.019	0.026	0.038	0.051	0.066	0.079	0.11	0.13	0.17
Aluminium-cast alloys 3.2131 G-AlSi5Cu1. 3.2153 G-AlSi7Cu3. 3.2573 G-AlSi9 3.2581 G-AlSi12. 3.2583 G-AlSi12Cu. - G-AlSi12CuNiMg	≥ 7% Si	Slotting	1 x D	80	0.016	0.021	0.032	0.042	0.055	0.066	0.09	0.11	0.14
		Roughing	0.75 x D	100	0.018	0.024	0.037	0.049	0.063	0.076	0.10	0.13	0.16
		Finishing	0.02 x D	160	0.017	0.023	0.035	0.047	0.061	0.073	0.10	0.12	0.15
Magnesium-alloys MgMn2. G-MgAl8Zn1. G-MgAl6Zn3	-	Slotting	1 x D	75	0.016	0.021	0.032	0.042	0.055	0.066	0.09	0.11	0.14
		Roughing	0.75 x D	90	0.018	0.024	0.037	0.049	0.063	0.076	0.10	0.13	0.16
		Finishing	0.02 x D	150	0.017	0.023	0.035	0.047	0.061	0.073	0.10	0.12	0.15
Non-ferr. met. (copper short-/long-chipp. brass/bronze) 2.0070 SE-Cu. 2.1020 CuSn6. 2.1096 G-CuSn5ZnPb 2.0380 CuZn39Pb2. 2.0401 CuZn39Pb3. 2.0410 ... 2.0250 CuZn20. 2.0280 CuZn33. 2.0332 CuZn37Pb0.5 2.1090 CuSn7ZnPb. 2.1170 CuPb5Sn5. 2.1176 ... 2.0916 CuAl5. 2.0960 CuAl9Mn. 2.1050 CuSn10	≤ 850 N/mm²	Slotting	1 x D	80	0.014	0.019	0.029	0.038	0.050	0.060	0.08	0.10	0.13
		Roughing	0.75 x D	100	0.017	0.022	0.033	0.044	0.058	0.069	0.09	0.12	0.14
		Finishing	0.02 x D	160	0.016	0.021	0.032	0.042	0.055	0.066	0.09	0.11	0.14

Milling conditions:

	unstable machining conditions low drive power
	short tools
	long tools

Correction factors:

	ap roughing > 1.5 x D	vc -25%	fz -25%
	medium length tools	vc -40%	fz -40%
	extra length tools	vc -60%	fz -55%
	uncoated tools	vc -50%	fz -25%



Material	Hardness	Application	ae max	Vc	fz (mm/z) with nom. Ø									
					3	4	6	8	10	12	16	20	25	
Struct./free-cutting steels, unall. heat-treat./case hard. steels 1.0035 S185. 1.0486 P275N. 1.0345 P235GH. 1.0050. 1.0070. 1.8937 1.0718 11SMnPb30. 1.0736 11SMn37 1.0402 C22. 1.1178 C30E 1.0503 C45. 1.1191 C30E 1.0301 C10. 1.1121 C10E 1.1750 C75W. 1.2076 102Cr6. 1.2307 29CrMoV9	≤ 850 N/mm²	Slotting	1 x D	40	0.016	0.021	0.031	0.042	0.060	0.072	0.10	0.12	0.15	
		Roughing	0.75 x D	50	0.018	0.024	0.036	0.048	0.069	0.083	0.11	0.14	0.17	
		Finishing	0.02 x D	80	0.017	0.023	0.034	0.046	0.066	0.079	0.11	0.13	0.17	
Free-cutting steels, unall. case hard. steels, nitr. steels 1.0727 46 S20. 1.0728 60 S20. 1.0757 46SPb20 1.0601 C60. 1.1221 C60E 1.7043 38Cr4 1.5752 15NiCr13. 1.7131 16MnCr5. 1.7264 20CrMo5 1.8504 34CrAl6 1.8519 31CrMoV9. 1.8550 34CrAlNi7	850-1.200 N/mm²	Slotting	1 x D	35	0.014	0.019	0.029	0.038	0.055	0.066	0.09	0.11	0.14	
		Roughing	0.75 x D	50	0.017	0.022	0.033	0.044	0.063	0.076	0.10	0.13	0.16	
		Finishing	0.02 x D	70	0.016	0.021	0.032	0.042	0.061	0.073	0.10	0.12	0.15	
Alloyed heat-treatable, tool and high speed steels 1.5131 50MnSi4. 1.7003 38Cr2. 1.7030 28Cr4 1.5710 36NiCr6. 1.7035 41Cr4. 1.7225 42CrMo4 1.2080 X210Cr12. 1.2083 X42Cr13. 1.2419 105WCr6. 1.2379 X155CrVMo12-1 1.3243 S 6-5-2-5. 1.3343 S 6-5-2. 1.3344 S 6-5-3 Spring steel = 1.5026 55Si7. 1.7176 55Cr3. 1.8159 51CrV4	850-1.400 N/mm²	Slotting	1 x D	25	0.014	0.018	0.027	0.036	0.050	0.060	0.08	0.10	0.13	
		Roughing	0.75 x D	30	0.016	0.021	0.031	0.041	0.058	0.069	0.09	0.12	0.14	
		Finishing	0.02 x D	50	0.015	0.020	0.030	0.040	0.055	0.066	0.09	0.11	0.14	
Hardened steel Tool steel, heat-treatable steel, spring steel, high-speed steel, case hardened steel, etc. Z.B.: 1.2344 X40CrMoV5-1; 1.2767 X45NiCrMo4; 1.2379 X155CrVMo12-1; 1.2080 X210Cr12; 1.3343 S 6-5-2	≤ 55 HRC	Slotting												
		Roughing												
		Finishing												
	55 - 63 HRC	Slotting												
		Roughing												
Stainless steel 1.4104 X14CrMoS17. 1.4105 X6CrMoS17. 1.4305 X10CrNiS18-9 USA = 303. 410. 420F. 430. 430F	≤ 750 N/mm²	Slotting	1 x D	30	0.014	0.018	0.027	0.036	0.050	0.060	0.08	0.10	0.13	
		Roughing	0.75 x D	40	0.016	0.021	0.031	0.041	0.058	0.069	0.09	0.12	0.14	
		Finishing	0.02 x D	60	0.015	0.020	0.030	0.040	0.055	0.066	0.09	0.11	0.14	
Stainless steel 1.4301X5CrNi18-10. 1.4303 X5CrNi18-12 1.4310 XCrNi18-8 USA = 304. 304L. 420	750-850 N/mm²	Slotting	1 x D	25	0.012	0.016	0.024	0.032	0.045	0.054	0.07	0.09	0.11	
		Roughing	0.75 x D	30	0.014	0.018	0.028	0.037	0.052	0.062	0.08	0.10	0.13	
		Finishing	0.02 x D	50	0.013	0.018	0.026	0.035	0.050	0.059	0.08	0.10	0.12	
Stainless steel 1.4438 X2CrNiMo18-15-4. 1.4404 X2CrNiMo17-12-2. 1.4571 X6CrNiTi18-10 USA = 310. 316. 316B. 316L. 317	≥ 850 N/mm²	Slotting	1 x D	15	0.011	0.014	0.021	0.028	0.040	0.048	0.06	0.08	0.10	
		Roughing	0.60 x D	20	0.013	0.017	0.025	0.034	0.048	0.058	0.08	0.10	0.12	
		Finishing	0.01 x D	30	0.011	0.014	0.021	0.028	0.040	0.048	0.06	0.08	0.10	
Special alloys (nickel based "Ni") Inimonic. Inconel. Monel. Hastelloy	≤ 1.300 N/mm²	Slotting	1 x D	8	0.008	0.011	0.017	0.022	0.032	0.038	0.05	0.06	0.08	
		Roughing	0.60 x D	10	0.010	0.013	0.020	0.027	0.038	0.046	0.06	0.08	0.10	
		Finishing	0.01 x D	15	0.008	0.011	0.017	0.022	0.032	0.038	0.05	0.06	0.08	
Titanium alloys ("Ti") 3.7024 Ti99.5. 3.7114 TiAl5Sn2.5. 3.7124 TiCu2 3.7154 TiAl6Zr5. 3.7164 TiAl6V4. 3.7184 TiAl4Mo4Sn2.5	≤ 1.300 N/mm²	Slotting	1 x D	15	0.012	0.016	0.024	0.032	0.045	0.054	0.07	0.09	0.11	
		Roughing	0.60 x D	20	0.014	0.019	0.029	0.038	0.054	0.065	0.09	0.11	0.14	
		Finishing	0.02 x D	30	0.013	0.018	0.026	0.035	0.050	0.059	0.08	0.10	0.12	
Cast/grey cast iron, spher.graphite/mall. cast iron 0.6010 EN-GL100 (GG10). 0.6020 EN-GJL-200 (GG20). 0.7050 EN-GJS-500-7 (GGG50). 0.8535 EN-GJMw-350-4 (GTW35)	≤ 240 HB	Slotting	1 x D	40	0.017	0.022	0.033	0.044	0.065	0.078	0.10	0.13	0.16	
		Roughing	0.75 x D	50	0.019	0.025	0.038	0.051	0.075	0.090	0.12	0.15	0.19	
		Finishing	0.02 x D	80	0.018	0.024	0.036	0.048	0.072	0.086	0.11	0.14	0.18	
Cast/grey cast iron, spher.graphite/mall. cast iron 0.6025 EN-GL250 (GG25). 0.6035 EN-GJL-350 (GG35). 0.7070 EN-GJS-700-2 (GGG70). 0.8170 EN-GJMB-700-2 (GTS70)	≥ 240 HB	Slotting	1 x D	30	0.015	0.020	0.030	0.040	0.055	0.066	0.09	0.11	0.14	
		Roughing	0.75 x D	40	0.017	0.023	0.035	0.046	0.063	0.076	0.10	0.13	0.16	
		Finishing	0.02 x D	60	0.017	0.022	0.033	0.044	0.061	0.073	0.10	0.12	0.15	
Aluminium. Al-wrought alloys. Al-alloys 3.0255 Al99.5. 3.2315 AlMgSi1. 3.3515 AlMg1 3.0615 AlMgSiPb. 3.1325 AlCuMg1. 3.3245 AlMg3Si. 3.4365 AlZnMgCu1.5	≤ 7% Si	Slotting	1 x D	100	0.020	0.026	0.039	0.052	0.080	0.096	0.13	0.16	0.20	
		Roughing	0.75 x D	120	0.022	0.030	0.045	0.060	0.092	0.110	0.15	0.18	0.23	
		Finishing	0.02 x D	200	0.021	0.029	0.043	0.057	0.088	0.106	0.14	0.18	0.22	
Aluminium-cast alloys 3.2131 G-AlSi5Cu1. 3.2153 G-AlSi7Cu3. 3.2573 G-AlSi9 3.2581 G-AlSi12. 3.2583 G-AlSi12Cu. - G-AlSi12CuNiMg	≥ 7% Si	Slotting	1 x D	70	0.017	0.022	0.033	0.044	0.060	0.072	0.10	0.12	0.15	
		Roughing	0.75 x D	100	0.019	0.025	0.038	0.051	0.069	0.083	0.11	0.14	0.17	
		Finishing	0.02 x D	140	0.018	0.024	0.036	0.048	0.066	0.079	0.11	0.13	0.17	
Magnesium-alloys MgMn2. G-MgAl8Zn1. G-MgAl6Zn3	-	Slotting	1 x D	65	0.015	0.020	0.030	0.040	0.055	0.066	0.09	0.11	0.14	
		Roughing	0.75 x D	80	0.017	0.023	0.035	0.046	0.063	0.076	0.10	0.13	0.16	
		Finishing	0.02 x D	130	0.017	0.022	0.033	0.044	0.061	0.073	0.10	0.12	0.15	
Non-ferr. met. (copper, short-/long-chipp. brass/bronze) 2.0070 SE-Cu. 2.1020 CuSn6. 2.1096 G-CuSn5ZnPb 2.0380 CuZn39Pb2. 2.0401 CuZn39Pb3. 2.0410 ... 2.0250 CuZn20. 2.0280 CuZn33. 2.0332 CuZn37Pb0.5 2.1090 CuSn7ZnPb. 2.1170 CuPb5Sn5. 2.1176 ... 2.0916 CuAl5. 2.0960 CuAl9Mn. 2.1050 CuSn10	≤ 850 N/mm²	Slotting	1 x D	60	0.017	0.022	0.033	0.044	0.060	0.072	0.10	0.12	0.15	
		Roughing	0.75 x D	70	0.019	0.025	0.038	0.051	0.069	0.083	0.11	0.14	0.17	
		Finishing	0.02 x D	120	0.018	0.024	0.036	0.048	0.066	0.079	0.11	0.13	0.17	



Application	Milling cutter type	Type	Helix angle	No. of teeth	Tool illustration	Material to ISO						Slot drilling	Roughing	Finishing	Copying	Page
						P	M	K	N	S	H					
MTC	RF 100 U	N	41/43/45°	3		<1400 N/mm² ●	●	> 200 HB30 ●	●	Ti & Ni ○		●	●			15
HPC	RF 100 U	N	35/38°	4		●		> 200 HB30 ●			< 48 HRC ○	●	●	●		33
HPC	RF 100 U (corner radius)	N	35/38°	4		●		> 200 HB30 ●			< 48 HRC ○	●	●	●	●	42
MTC	RF 100 U/HF	HF	30/32°	4		●		> 200 HB30 ●				○	●			44
HPC	RF 100 Diver	N	36/38/37°	4		●	●	●	●	Ti & Ni ●		●	●	●		24
HPC	RF 100 F	NH	40/42°	4		<1000 N/mm² ●	<900 N/mm² ●		○	Ti & Ni ●		●	●	●		27
HPC	RF 100 Speed	NH	48°	4		●	●			Ti & Ni ●		○	●	●		31
HPC	RF 100 VA	N	36/38°	4		<850 N/mm² ●	●		< 7% Si ○	Ti & Ni ●		●	●	●		79
HPC/HSC	RF 100 VA (b-nosed)	N	36/38°	4		<850 N/mm² ●	●		●	Ti & Ni ●		●	●	●	●	83
MTC	RF 100 VA/NF	NF	36/38°	4		<850 N/mm² ●	●	●	< 7% Si ○	Ti & Ni ○		○	●			84
HPC	RF 100 A	W	40/42°	4			○		●	Ti & Ni ○		○	●	●		123
HPC	RF 100 A	W	39/40/41°	3					●			●	●	●		117
MTC	RF 100 A/WF	WF	29/30/31°	3					●			○	●			125
HPC/HSC	RF 100 H	NH	40/42°	4		<1000 N/mm² ●		> 200 HB30 ●			< 63 HRC ●	○	●	●		61
HPC	RF 100 Ti (corner radius)	N	35/38°	4		●	●			Ti & Ni ●		●	●	●	○	100
HPC/HSC	RF 100 S/F	NH	45°	5		●	●	●	●	Ti & Ni ●	< 48 HRC ○		○	●		52
HPC/HSC	RF 100 S/F	NH	44/45/46°	6		●	●	●	●	Ti & Ni ●	< 48 HRC ○		○	●		53
HPC	RF 100 Raptor	NH	35°-46°	3-6		●	●		●	Ti & Ni ●		●	●	●		107

● = optimal suitability ○ = limited suitability

HPC = maximum metal removal rate; HSC = highest speed; MTC = instable conditions

Chapter Divisions for Material Classification

Within the program pages the optimum tool is offered based on the Material Classification

Application group	Material examples	Chapter
P	Steel, high-oxyed steel	Steel
M	Stainless steel	Stainless
K	Grey iron, spher.graph. iron and mable cast iron	Steel
N	Aluminium and other non-ferrous metals	Aluminium and Diamond
S	Special-, super- and titanium- oys	Stainless
H	Hardened steel and chilled cast iron	Steel and radius milling cutters

Application	Milling cutter type	Type	Helix angle	No. of teeth	Tool illustration	Material to ISO						Slot drilling	Roughing	Finishing	Copying	Page
						P	M	K	N	S	H					
MTC	GH 100 U	NH	45°	3		<1400 N/mm² ●	●	●	○	Ti & Ni ○		●	●	○		17
HPC	GA 200 A	W	45°	3					●			●	●	●	●	127
MTC	RS 100 U	NF	30°	4-5		<1000 N/mm² ●	●	●	< 7% Si ○	Ti & Ni ●		○	●		47	
MTC/ HPC	RS 100 F	NF	45°	5-6		●		> 200 HB30 ●			< 48 HRC ○	○	●		48	
MTC	GS 100 A	WR	30°	3					●			●	●		132	
MTC	GS 100 U	NRf	30°	4-5		●	<900 N/mm² ●	< 240 HB30 ●	< 7% Si ○	Ti & Ni ○		○	●		49	
MTC	GS 100 H	HR	20°	4		>1000 N/mm² ○		< 300 HB30 ●			< 55 HRC ●	●	●		64	
HPC/ HSC	GH 100 U	NH	45°	6-10		●	●	●	●	Ti & Ni ●	< 48 HRC ○		●		56	
HPC/ HSC	GH 100 U (corner radius)	NH	45°	6-8		●	●	●	●	Ti & Ni ●	< 48 HRC ○		●	●	178	
HPC/ HSC	GH 100 H	H	55°	6-8		>1000 N/mm² ○		< 300 HB30 ●			< 63 HRC ●	○	●	●	67	
HPC/ HSC	GH 100 H (corner radius)	H	55°	6		>1000 N/mm² ○		< 300 HB30 ●			< 63 HRC ●		●	●	66	
MTC/ HPC	FR 100	N	0°	4-8						CFK		●	●	●	149	
HPC	CR 100	N	0°	6-14						CFK		●	●	●	152	
MTC	Pilot end mill	N	30°	4		●	○	●	< 7% Si ○	Ti & Ni ○			●	●	22	
HSC	GF 300 B	H	30°	2/4		<1000 N/mm² ●		< 300 HB30 ●			< 63 HRC ●		●	●	209	
HSC	GF 300 T	H	30°	4		<1000 N/mm² ●		< 300 HB30 ●			< 63 HRC ●	○	●	●	188	
HSC	HF 300	H	30°	4		●	●	●		Ti & Ni ●	< 55 HRC ●	●	●	●	186	
HSC	GF 500 B	N	30°	2/4		●	●	< 240 HB30 ●	< 7% Si ○	Ti & Ni ●	< 55 HRC ○	○	●	●	199	
HSC	GF 500 T	N	30°	2/4		●	●	< 240 HB30 ●	< 7% Si ○	Ti & Ni ●	< 55 HRC ○	○	●	●	179	
HSC	End mills, PCD-tipped	-	2°-4°	2-3					●	CFK Graphite		●	●	●	157	

● = optimal suitability ○ = limited suitability

HPC = maximum metal removal rate; HSC = highest speed; MTC = instable conditions



Application	Milling cutter type	Type	Helix angle	No. of teeth	Tool illustration	Material to ISO						Slot drilling	Roughing	Finishing	Copying	Page
						P	M	K	N	S	H					
Uni	Slot drills (Aluminium)	W	45°	2					●			●	●	○		129
Uni	Slot drills	N	30°	2		< 1000 N/mm ² ●	●	< 240 HB30 ●	●			●	○			233
Uni	Slot drills (corner radius)	N	30°	2		●	<900 N/mm ² ●	< 240 HB30 ●	●		< 48 HRC ○	●	○		●	176
Uni	Slot drills (b-nosed)	N	30°	2		●	<900 N/mm ² ●	< 240 HB30 ●	●	Ti & Ni ●	< 48 HRC ○				●	192
Uni	Slot drills	N	30°	3		< 1000 N/mm ² ●	●	< 240 HB30 ●	●			●	○	○		243
Uni	Slot drills (Mini-slot drills)	N	30°	3		<850 N/mm ² ●	<900 N/mm ² ●	< 240 HB30 ○	●	< 1000 N/mm ² ○		●	○	○		250
Uni	Slot drills (Mini-slot drills)	NH	45°	3		< 850 N/mm ² ●	●	< 240 HB30 ○	●	< 1000 N/mm ² ○		●	●	○		251
Uni	End Mills	N	30°	4		< 1000 N/mm ² ●	●	< 240 HB30 ●	●						●	252
Uni	End Mills (corner radius)	N	30°	4		●	●	< 240 HB30 ●	< 7% Si ○	Ti & Ni ○	< 48 HRC ○	○	●	●	●	177
Uni	End Mills (b-nosed)	N	30°	4		●	○	●	< 7% Si ○	Ti & Ni ●	< 48 HRC ○				●	195
Uni	Chamfering milling cutters 60°	N	7°	4		●	●	●	●	Ti & Ni ●	< 55 HRC ○				●	226
Uni	Chamfering milling cutters 90°	N	7°	4		●	●	●	●	Ti & Ni ●	< 55 HRC ○				●	227
Uni	Chamfering milling cutters 120°	N	7°	4		●	●	●	●	Ti & Ni ●	< 55 HRC ○				●	229
Uni	Chamfering milling cutters 90° (Signum)	H	7°	4		●	●	●		Ti & Ni ●	< 63 HRC ●				●	228
Uni	Chamfering milling cutters 90° (Z6)	N	7°	6		●	●	●	●	Ti & Ni ○			●	●		230
Uni	Front and back de-burrer	N	0°	4		●	●	●	●	Ti & Ni ○	< 55 HRC ○				●	231

● = optimal suitability ○ = limited suitability

Chapter Divisions for Material Classification

Within the program pages the optimum tool is offered based on the Material Classification

Application group	Material examples	Chapter
P	Steel, high-oxyed steel	Steel
M	Stainless steel	Stainless
K	Grey iron, spher.graph. iron and mable cast iron	Steel
N	Aluminium and other non-ferrous metals	Aluminium and Diamond
S	Special-, super- and titanium- oys	Stainless
H	Hardened steel and chilled cast iron	Steel and radius milling cutters
FK / Graphite	Fibre plastic materials and graphite	Diamond

Correct milling with the most efficient strategies

HPC & HSC milling strategies

These milling strategies belong to the state-of-the-art and most effective application methods for current solid carbide milling tools. When applied, an enormously high metal removal rate ensures a considerable increase in productivity. Very high cutting parameters can be achieved even with less powerful machines or unstable machining conditions. With difficult-to-machine materials or unfavourable diameter-length-ratios of the tools a massive increase of process reliability can be achieved.



HIGH PERFORMANCE CUTTING

max. metal removal rate/time → stable conditions; short de-clamping; high performance; good cooling



HIGH SPEED CUTTING

at high speed/high feed rate → high dynamics; low cutting depth; low drive power

Principles and objectives

Maximum tool utilisation

- utilisation of entire cutting edge length
- full power delivery
- increased tool life
- balanced wear

Modification of cutting distribution

- low cutting widths a_e
- high cutting depths a_p

High process reliability

- low tool wrapping
- improved thermal conditions at tool cutting edge
- low mechanical stress

Maximum metal removal rate

- saving time/machine costs





Foundations for economically efficient milling

Peripheral requirements

Applicable in every material group

- P K H M S N
- easy to machine materials = increase in productivity
- difficult to machine materials = increase in process reliability

High-dynamic machining centres

- short acceleration distances
- higher speed range
- small to medium tool diameters

Heavy machines

- stable feed axes
- high spindle torque
- medium to large tool diameters

Unstable to stable workpiece clamping

- stable = vibration-free machining = maximum metal removal rate
- unstable = reduction of radial forces = increased process reliability

Application parameters

Low cutting width a_e to $0.33 \times D$

- low angle of engagement $< 70^\circ$
- short t. of contact between cutting edge and component

Very high tooth feed f_z

- reduced chip thickness allows considerably higher f_z

Very high cutting speed v_c

- reduced heating up and prolonged cooling down allow very high v_c values

High cutting depth a_p

- improved leverage effect
- high metal removal rate
- increase in contact points between tool and component

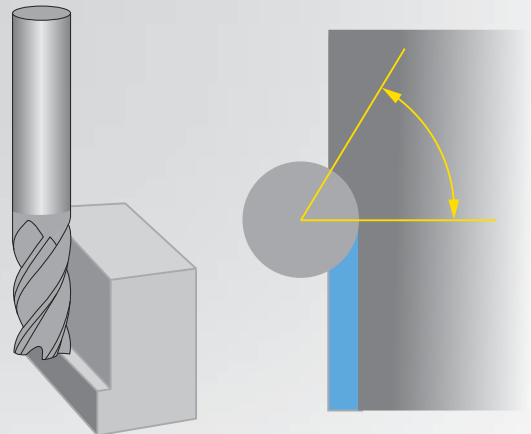

Tool angle of engagement & tool contact time

Metal removal rate

The metal removal rate specifies how high the actual chip removal is per minute. It is especially suitable for comparing different machining strategies.

$$a_p \text{ (mm)} \times a_e \text{ (mm)} \times v_f \text{ (m/min)} = Q \text{ (cm}^3\text{/min)}$$

Influence on process through tool engagement

Angle of engagement

The angle of engagement inscribes the cutting range of the tool from start of chip formation to exit from the material. With these parameters the stress impacting on the tool can be assessed. With straight milling paths the angle is constant, with concave milling paths it increases and with convex milling paths it decreases.

Straight milling path

- constant angle of engagement
- constant tool stress

Example: $ae = 0.20 \times D = 53^\circ$ engagement
Engagement remains a constant 53°

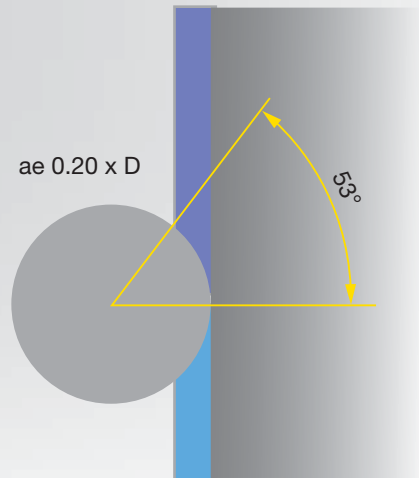

Angle of engagement with convex contour radii

Convex milling path

- decreasing angle of engagement
- reduced tool stress

Example: $ae = 0.20 \times D = 53^\circ$ engagement
Engagement reduces to 45°

Measures: ae may be increased
 fz can be increased

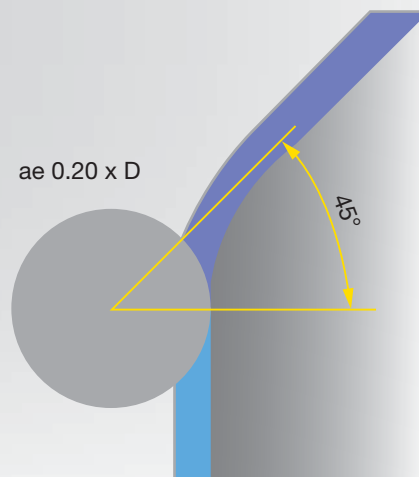

Angle of engagement with concave contour radii

Concave milling path

- increasing angle of engagement
- increased tool stress

Example: $ae = 0.20 \times D = 53^\circ$ engagement
Engagement increases to 74°

Measures: ae must be reduced
 fz must be reduced in radius

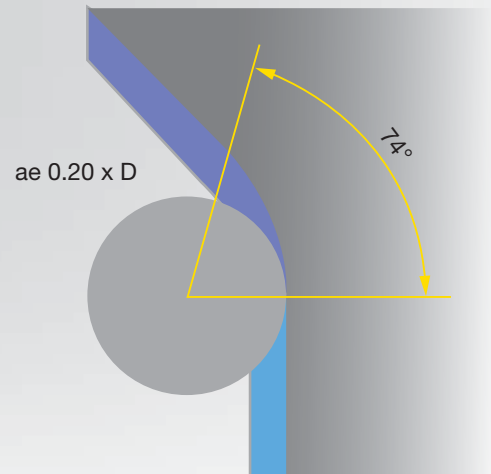



Influence on process through tool engagement

Angle of engagement with 90° corner radii

Tool radius = Corner radius

- very unfavourable for tool dynamics
- change of stress direction
- abrupt increase in tool stress

Example: Increase of engag. angle from 53° to 143° (270°)

Measures: v_c and f_z must be heavily reduced

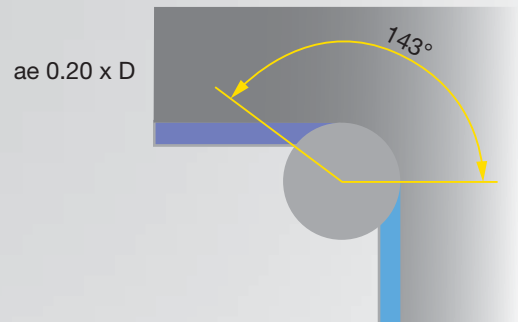

Tool radius = Corner radius

- machine can interpolate the path
- no "impact" on tool
- lower increase of tool stress

Example: Increase of engag. angle from 53° to 92° (174°)

Measures: ae must be reduced
 f_z must be heavily reduced in radius

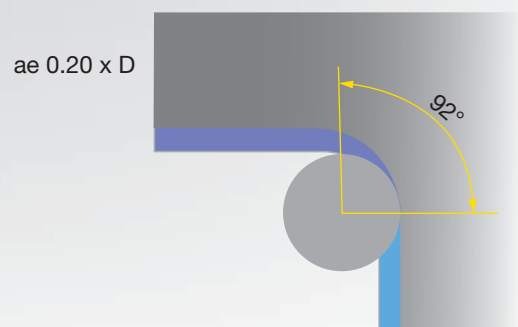

Ratio of flute width to tool diameter with trochoidal milling

Flute width 1.7 – 2.0 x D

- cut in C-arc
- ae max. $0.10 \times D$ (theor. 37°)
- Increase of angles of engagement by up to 50%

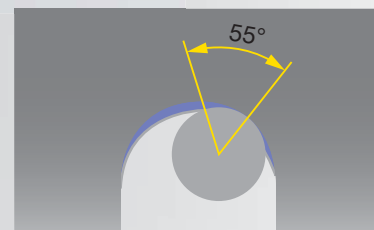

Flute width 2.1 – 3.0 x D

- cut in C-arc
- ae max. $0.15 \times D$ (theor. 46°)
- Increase of angles of engagement by up to 50%

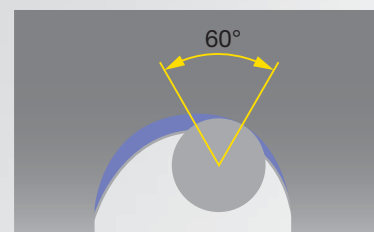

Flute width ab 3.1 x D

- cut in D arc
- ae max. $0.20 \times D$ (theor. 53°)
- increase of angles of engagement by up to 40%

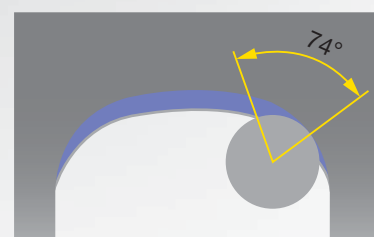



Guide values for increasing the cutting values with cutting edge lengths up to 3 x D					
GTC HPC HSC Roughing and HSC finishing					
Material	Application	radial feed in % of Ø	vc factor *	fz factor *	Angle of engagement
N P K M S	Slotting	100%	1	1	180°
	HPC Roughing	33%	1,5	1,3	70°
	HPC Roughing	25%	1,6	1,5	60°
	HPC Roughing	20%	1,7	1,6	53°
	HPC Roughing	15%	1,8	1,9	46°
	HSC Roughing	10%	1,9	2,3	37°
	HSC Roughing	8%	2,0	2,5	31°
	HSC Roughing	5%	2,1	2,5	26°
N P K M S	HSC Finishing	3%	2,0	1,2	20°
	HSC Finishing	2%	2,0	1,1	18°
	HSC Finishing	1%	2,0	1,0	11°
	HSC fine finishing	0,5	2,2	0,9	8°

* base value for the calculation with vc and fz factors is the value specified in the Guhring Navigator for "slotting" in the respective material group.



Base cutting values slotting – RF 100 tools – smooth cutting

Material	Hardness	Application	Vc	fz (mm/z) with nom. Ø									
				3	4	5	6	8	10	12	16	20	25
P1	≤ 850 N/mm ²	Slotting	180	0,015	0,020	0,025	0,030	0,040	0,060	0,072	0,096	0,120	0,150
P2	850-1200 N/mm ²	Slotting	160	0,014	0,019	0,024	0,029	0,038	0,055	0,066	0,088	0,110	0,138
P3	850-1400 N/mm ²	Slotting	135	0,014	0,018	0,023	0,027	0,036	0,050	0,060	0,080	0,100	0,125
M1	< 750 N/mm ²	Slotting	120	0,014	0,018	0,023	0,027	0,036	0,050	0,060	0,080	0,100	0,125
M2	750-850 N/mm ²	Slotting	80	0,012	0,016	0,020	0,024	0,032	0,045	0,054	0,072	0,090	0,113
M3	> 850 N/mm ²	Slotting	70	0,011	0,014	0,018	0,021	0,028	0,040	0,048	0,064	0,080	0,100
S-Ni	≤ 1300 N/mm ²	Slotting	30	0,008	0,011	0,014	0,017	0,022	0,032	0,038	0,051	0,064	0,080
S-Ti	≤ 1300 N/mm ²	Slotting	60	0,012	0,016	0,020	0,024	0,032	0,045	0,054	0,072	0,090	0,113
K1	≤ 240 HB	Slotting	160	0,017	0,022	0,028	0,033	0,044	0,065	0,078	0,104	0,130	0,163
K2	> 240 HB	Slotting	140	0,015	0,020	0,025	0,030	0,040	0,055	0,066	0,088	0,110	0,138
Wr. al. alloy	≤ 5% Si	Slotting	500	0,020	0,026	0,033	0,039	0,052	0,075	0,090	0,120	0,150	0,188
Cast al. alloy	> 5% Si	Slotting	230	0,017	0,022	0,028	0,033	0,044	0,060	0,072	0,096	0,120	0,150
Non-fer.metals	≤ 850 N/mm ²	Slotting	250	0,017	0,022	0,028	0,033	0,044	0,060	0,072	0,096	0,120	0,150

Metal removal rate a_p (mm) X a_e (mm) X v_f (m/min) = Q (cm³/min)

Example:	HPC roughing: 15% ae ; 2 x D ap ; C45
Tool:	RF 100 U Ø 12mm - 4 flutes
Feed:	radial feed ae 1.8 mm = 15% of D
Base value slotting	vc slotting = 180 m/min, fz slotting= 0.072 mm
Conversion:	vc factor = 1.8 → vc: 180 m/min x 1.8 = vc 324 m/min fz factor = 1.9 → fz: 0.072 mm x 1.9 = fz 0.137
Increased values:	vc: 324 m/min / fz: 0.137 mm n: 8594 U/min / vf: 4710 mm/min
Metal removal rate:	Q = 203 cm ³ /min



HPC & HSC milling – fully optimised application examples

Application example – material 16MnCr5

RF 100 Speed, #6761, Ø 16 mm,
HPC clamping chuck + PINLock-safety
vc 410 m/min fz 0.450 mm hm 0.123 mm
ae 1.2 mm ap 45 mm vf 14690 mm/min
Q = 793 cm³/min

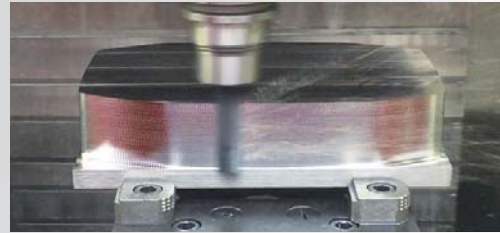

Application example – material Hardox 400®

RF 100 U, #3871, Ø 20 mm,
Weldon clamping chuck
vc 200 m/min fz 0.180 mm hm 0.049 mm
ae 1.5 mm ap 55 mm vf 2290 mm/min
Q = 189 cm³/min



HPC & HSC milling – strategy comparison

Application comparison – material 42CrMo4

Gühring

RF 100 Diver, #6736, Ø 12 – Z4,
Weldon clamping chuck
vc 300 m/min fz 0.120 mm
n 7960 U/min vf 3820 mm/min
ae 1.5 mm ap 24 mm
Q = 138 cm³/min



5 radial cuts per 1200 mm path
Machining time = **1.34 min**

Application comparison – material 42CrMo4

Competition

HPC milling cutter, Ø 16 – Z4
Weldon clamping chuck
vc 140 m/min fz 0.070 mm
n 2790 U/min vf 780 mm/min
ae 7.5 mm ap 12 mm
Q = 70 cm³/min



2 radial cuts per 1200 mm path
Machining time = 3.05 min

Application comparison – material 1.4301

Gühring

RF 100 SF, #3632, Ø 16 – Z6,
Weldon clamping chuck
vc 160 m/min fz 0.100 mm
n 3185 U/min vf 1910 mm/min
ae 1.2 mm ap 30 mm
Q = 69 cm³/min



10 axial cuts per 900 mm path
Machining time = **4.43 min**

Application comparison – material 1.4301

Competition

Indexable inserted milling cutter Ø 25 – Z3
vc 200 m/min fz 0.120 mm
n 2550 U/min vf 920 mm/min
ae 12 mm ap 2 mm
Q = 22 cm³/min

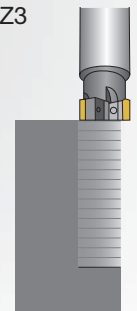

15 axial cuts per 900 mm path
Machining time = 14.40 min

Plunging strategies and guide values

General plunging with standard face geometries



Ramping

- ramping angle = $2^\circ - 5^\circ$ to max. ap 1 x D
- even load increase



Oscillating

- ramping angle = $1^\circ - 4^\circ$ to max. ap 1 x D
- results in load peaks



Helix

- feed = $0.05 - 0.1 \times D$ per revolution
- smallest diameter to be produced = $1.7 \times D$



Grooving

- alternative when problems through excess. radial forces
- ae $0.25 \times D$ – ap cutting edge length / clearance ground length



Drilling / pilot drilling

- max. depth feed $0.5 \times D$ then pecking

Base fz = fz slotting

fz 75%



fz 75%

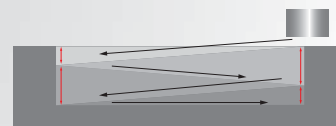

fz 100%

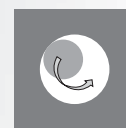

fz 100%



fz 50%

Special plunging – tools with special plunging geometry



RF 100 Diver - #6736 / #6737

- h10 cutting edge tolerance
- $36^\circ/37^\circ/38^\circ$ helix
- reduced and nominal diameter
- good drilling characteristics
- very good milling characteristics

First choice: Milling and plunging



Ramping

- ramping angle = $15^\circ - 45^\circ$ to max. ap 1 x D



Oscillating

- ramping angle = $10^\circ - 20^\circ$ bis max. ap 1 x D



Helix

- feed = $0,10 - 0,30 \times D$ pro Umdrehung
- smallest diameter to be produced = $1,7 \times D$



Grooving

- altern. when problems through excessive radial forces
- ae $0,25 \times D$ - ap cutting edge length/ clearance grind l.



Drilling / pilot drilling

- max. depth feed $1.0 \times D$ then pecking



Pilot milling cutter RF 100 P - #6716







- m8 cutting edge tolerance
- 30° helix
- a multitude of individual dimensions
- very good drilling characteristics
- sufficient milling characteristics

First choice: Drilling and pilot drilling

Cutting values “special plunging”
to cutting value tables RF 100 Diver & RF 100 P



General recommendation for tool cooling

Steel			<ul style="list-style-type: none"> • Avoid thermal shock
Cast iron		Dry machining, compressed air, MQL:	<ul style="list-style-type: none"> • Dissipate machining temperature via chip • Supporting chip evacuation
Hardened			
Stainless		Soluble oil, neat oil:	<ul style="list-style-type: none"> • Cooling of tool cutting edge • Preventing built-up edge • Supporting chip evacuation
Special alloy			
Non-ferrous metals		Soluble oil, neat oil:	<ul style="list-style-type: none"> • Preventing built-up edge • Supporting chip evacuation

Exceptions for material ranges



When **coolant** is not available the cutting speed (v_c) and/or the radial feed (a_e) should be reduced. The resulting reduced temperature reduces the risk of thermal shock.

If there are **chip evacuation problems** the application of coolant should be taken into consideration, poor evacuation of chips can lead to massive tool wear and even tool breakage.

When **heat is being generated due to poor chip evacuation**, it should be checked if through coolant is available. By using a specifically directed “coolant jet”, coolant can be supplied where congested without hitting the cutting area. Alternatively, the application of coolant for the entire machining operation is recommended.

Other notes

Finishing

The application of coolant is principally an advantage as a better surface finish can be achieved.

Very long tools

Coolant can result in a smoother process, as the lubricant has a vibration-reducing effect.

Alignment of coolant

- as accurate as possible in the cutting area from at least three directions
- no flushing back of small chips to the cutting area



Solid carbide milling cutters with internal cooling

- optimal chip evacuation, very good cutting edge cooling, very effective against built-up edges
- to be recommended especially for larger tool diameters and tough materials

Peripheral cooling / Gührojet

Best external option: Optimal tool cooling and chip evacuation thanks to the direct route from coolant exit to cutting area

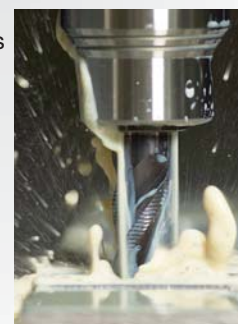

GÜHROJET

General notes

All the cutting rate recommendations specified in this catalogue are standard values valid exclusively for new tools or tools re-ground to Guhring specifications. Pre-requisites are stable machines, optimal cooling, optimal tool clamping and maximum concentricity of the tool and the machine spindle. Our

recommended cutting rates must be reduced if the conditions deviate. The values may also be adjusted to influence surface quality, machining rate or tool life.

1. Workpiece clamping

Loss of tool life or tool breakage through unstable clamping

- improve workpiece clamping

Alternative:

- reduce feed
- reduce cutting width or depth

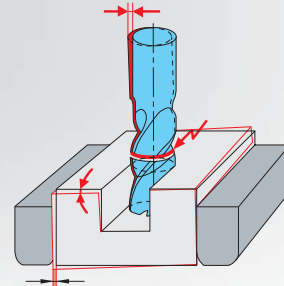

2. Tool clamping

Loss of tool life or tool breakage through unstable, worn or too small/long/thin tool holder

- apply new or larger tool holder or holder with increased clamping force and increased concentricity

Alternative:

- reduce cutting rates
- reduce clamping length
- apply tool with smaller diameter
- check clamping screws for wear

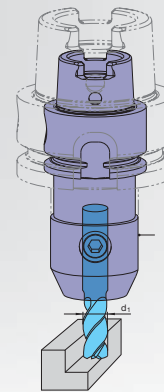

3. Surface quality

Excessive peak-to-valley height R_a/R_z at the tool surface through excessive feed and feed rates or vibrations

- improve workpiece clamping and tool clamping (see points 1 and 2)

Alternative:

- reduce feed and feed rate
- increase cutting speed

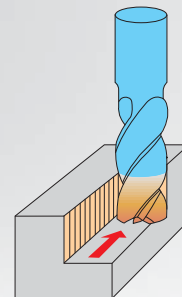

4. Vibrations

High tool wear, insufficient workpiece surface quality and insufficient dimensional accuracy through vibration

- improve workpiece and tool clamping (see points 1 and 2)
- increase tooth feed, because the chip centre thickness is too small
- modify speed
- modify milling strategy, i.e. select alternative cutting distribution
- change tool selection, i.e. reduce no. of teeth or spiral

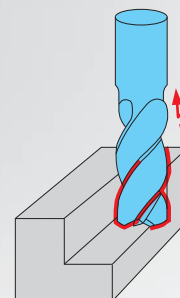



5. Chip congestion/cooling

Significant reduction in tool life, crumbling on cutting lips, edge build-up or conglutination of flutes through insufficient chip evacuation

- select milling cutters with internal cooling

Alternative:

- peripheral cooling via GM 300 chuck
- increase volume flow
- adjust coolant flow
- apply compressed air cooling (according to tool and material)
- reduce feed rate
- modify cutting distribution

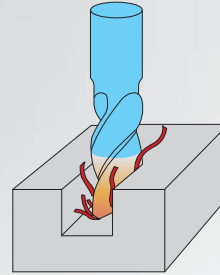

6. Pecking when drilling

Significant reduction in tool life as well as crumbling of cutting lips through insufficient chip evacuation and thermal stresses

- select milling cutter with internal cooling
- with drilling depths $> 0.5 \times D$ pecking in stages

Alternative:

- peripheral cooling via GM 300 chuck
- increase volume flow
- adjust coolant flow
- reduce feed rate

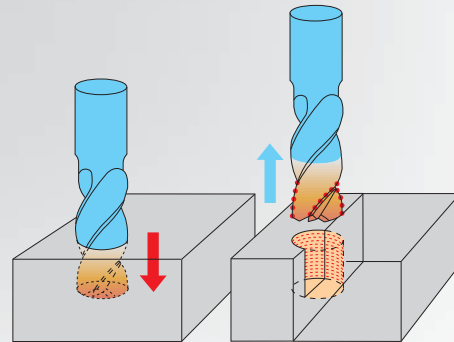

7. Thermal influence on materials

Through welding or torch cutting, the material characteristics at the parting line do not correspond with the specified material class

- reduce cutting rates
- select tool for materials with a higher tensile strength

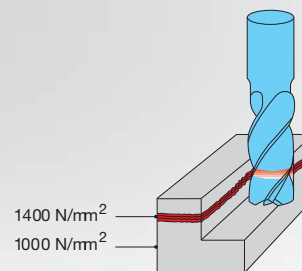

8. Entry in hardened materials

For entering materials over 1400 N/mm^2 (44HRC), reduce the feed rate v_f (mm/min) in accordance with the illustration on the right

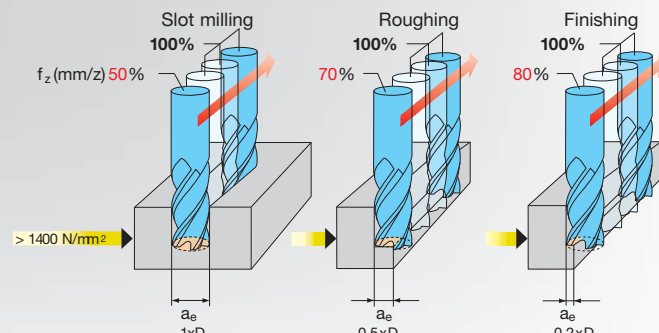

9. Loss in tool life with interrupted cutting

Significant loss in tool life through interrupted cutting (especially with milling angles of 90°)

- modify cutting distribution
- reduce feed rate for entry and exit
- reduce approach angle

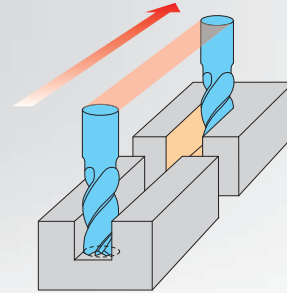

10. Feed rate adjustment: Modifying the cutting width

- when modifying the cutting width a_e , the feed rate must be reduced in accordance with the illustration on the right
- cutting speed or revolutions remain unchanged
- double reduction applies when also modifying the cutting depth a_p !



$a_e = 1 \times D$
 $f_z = 100 \%$



$a_e = 0,66 \times D$
 $f_z = 115 \%$

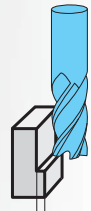

$a_e = 0,25 \times D$
 $f_z = 150 \%$

11. Feed rate adjustment: Modifying the cutting depth

- when modifying the cutting depth a_p , the feed rate must be reduced in accordance with the illustration on the right
- cutting speed or revolutions remain unchanged up to cutting depths of $3 \times D$, must only be adapted over $3 \times D$
- double reduction applies when also modifying the cutting width a_e !



$a_p = 1 \times D$
 $f_z = 100 \%$



$a_p = 2 \times D$
 $f_z = 50 \%$

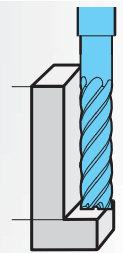

$a_p = 3 \times D$
 $f_z = 25 \%$

12. Plunging strategies: for drilling

- reduce feed rate v_f (mm/min.)
 - additional pecking for drilling depths $> 0.5 \times D$ or transition to radial machining
- Attention: Danger of breakage through abrupt load increase!

Oblique plunging up to 5°:

- reduce feed rate v_f (mm/min.) in accordance with the illustration on the right

Helical plunging:

- for helical plunging on a milling cycle, we recommend a feed of 0.1 to 0.2 per cycle
- reduce feed rate v_f (mm/min.) in accordance with the illustration on the right
- select preferred hole diameter $1.7 \times D$

Drilling

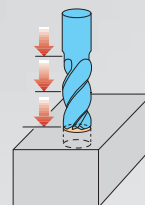

90°
 $f_z = 50 \%$

Oblique plunging

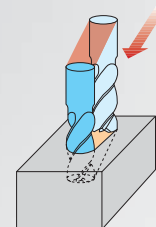

5°
 $f_z = 75 \%$

Helical plunging

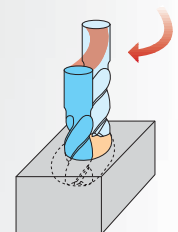

$f_z = 100 \%$



13. HSC milling with ball nosed copy milling cutters



HSC = High Speed Cutting:

Milling operations with very low metal removal but with consideration of the effective tool diameter.

3D machining with ball or Torus milling.

- low cutting width (a_e)
- low cutting depth (a_p)
- high feed rate per tooth (f_z)
- very high cutting speed (V_c)

At cutting depths $a_p < 0.2 \cdot D$ the actual engaged effective diameter $D_{(eff)}$ must be used to calculate the speed. It is derived from the graphic below with the spindle not engaged. To increase the tool life, we recommend machining with a tilted spindle.

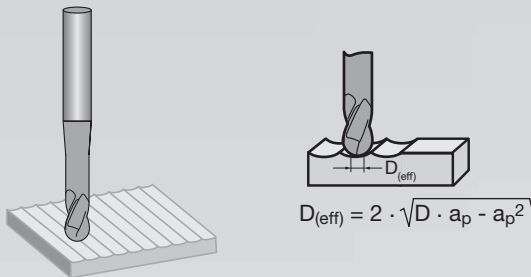

The ball-nosed milling cutter is perpendicular to the machining surface. In the centre of the tool is the cutting speed = 0. Tool life and surface quality are not optimal.

Function and Advantages

Calculation of the effective tool diameter

- adjusting speed to effective tool diameter
- Increasing the overall feed rate
- Improving the surface quality

Consideration of the pressure angle / width

- adjusting the tooth feed to achieve the required surface quality

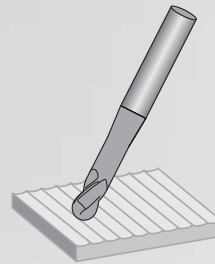

The ball-nosed milling cutter is oblique to the machining surface. The centre of the tool is not engaged. Tool life and surface quality are improved.

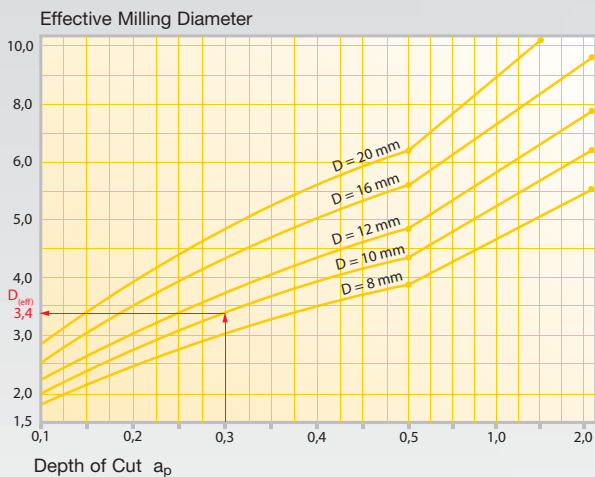

Example: For a full copy milling radius \varnothing 10 mm and a depth of cut a_p of 0.3 mm results in an effective diameter $D_{(eff)} = 3.4$ mm. This $D_{(eff)}$ shall be used to calculate the cutting speed V_c .

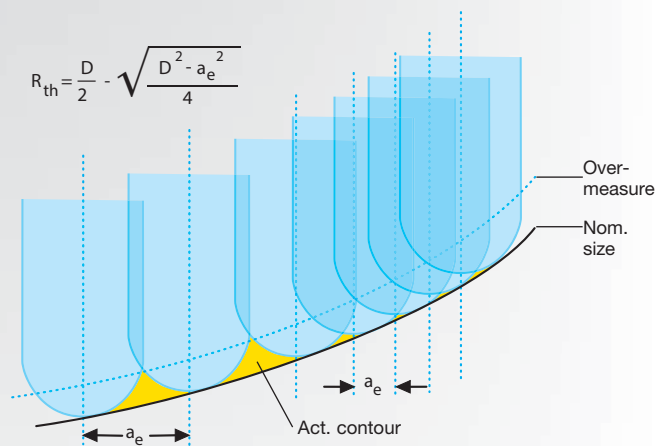

The reduction of the cutting width, a_e , leads to an improvement of the surface quality of the workpiece (reduced peak-to-valley height).

14. HSC milling with corner radius - copy milling cutters / Torus milling

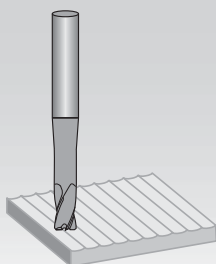

HSC milling & Torus milling

3D-machining with Torus milling cutters. Engagement of the tool predominantly on the corner radius. Improves the surface quality and the tool life. Of advantage when 3D-machining flat contour areas on 3-axis machines.

Form HA, plain

Dimensions in mm

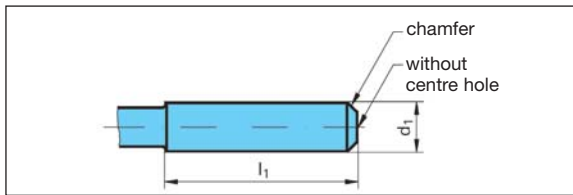

d ₁	l ₁
h6	+2 0
2	28
3	28
4	28
5	28
6	36

d ₁	l ₁
h6	+2 0
8	36
10	40
12	45
14	45
16	48

d ₁	l ₁
h6	+2 0
18	48
20	50
25	56
32	60

Form HB, with drive flat

Dimensions in mm

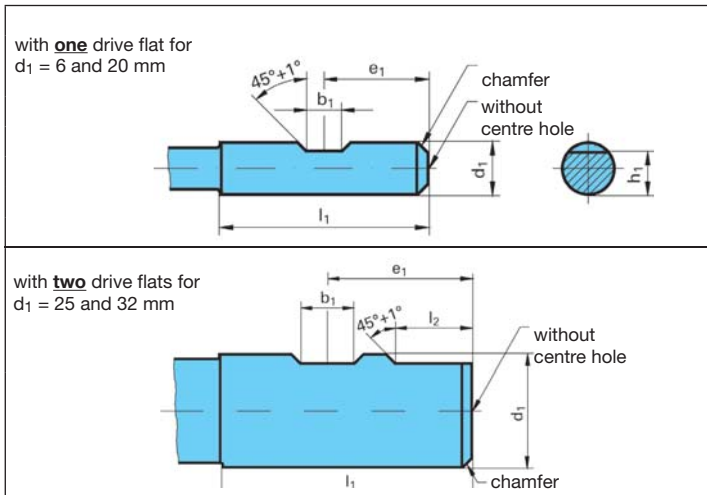

d ₁	b ₁	e ₁	h ₁	l ₁	l ₂
h6	+0.05 0	0 -1	h11	+2 0	+1 0
6	4.2	18	5.1	36	-
8	5.5	18	6.9	36	-
10	7	20	8.5	40	-
12	8	22.5	10.4	45	-
14	8	22.5	12.7	45	-
16	10	24	14.2	48	-
18	10	24	16.2	48	-
20	11	25	18.2	50	-
25	12	32	23	56	17
32	14	36	30	60	19

High speed steel straight shanks, DIN 1835-1 (extract)

Form A, plain

Dimensions in mm

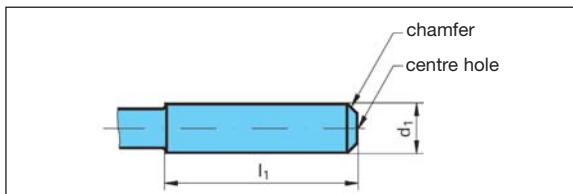

d ₁	l ₁
h8	+2 0
3	28
4	28
5	28
6	36
8	36

d ₁	l ₁
h8	+2 0
10	40
12	45
16	48
20	50
25	56

d ₁	l ₁
h8	+2 0
32	60
40	70
50	60
63	90

Form B, with drive flat

Dimensions in mm

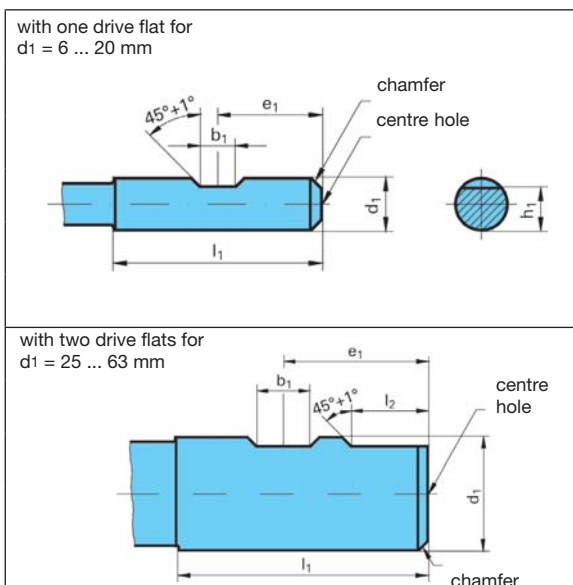

d ₁	b ₁	e ₁	h ₁	l ₁	l ₂	centre hole form R DIN 332 sect. 1
h6	+0.05 0	0 -1	h13	+2 0	+1 0	
6	4.2	18	4.8	36	-	1.6x2.5
8	5.5	18	6.6	36	-	1.6x3.35
10	7	20	8.4	40	-	1.6x3.35
12	8	22.5	10.4	45	-	1.6x3.35
16	10	24	14.2	48	-	2.0x4.25
20	11	25	18.2	50	-	2.5x5.3
25	12	32	23	56	17	2.5x5.3
32	14	36	30	60	19	3.15x6.7
40	14	40	38	70	19	3.15x6.7
50	18	45	47.8	80	23	3.15x6.7
63	18	50	60.8	90	23	3.15x6.7



Symbol	Description	metric	Formula
z	No. of teeth		
D	Milling cutter diameter	mm	
a_p	Depth of cut	mm	
a_e	Width of cut	mm	
l_f	Milling length	mm	
n	Revolution per min.	U/min	$n = \frac{v_c \cdot 1000}{\pi \cdot D}$
v_c	Cutting speed	m/min	$v_c = \frac{\pi \cdot D \cdot n}{1000}$
v_f	Feed per min.	mm	$v_f = n \cdot z \cdot f_z$
f_z	Feed per tooth	mm	$f_z = \frac{v_f}{n \cdot z}$
f/U	Feed per revolution	mm	$f/U = \frac{v_f}{n}$
f/U	Feed per revolution	mm	$f/U = f_z \cdot z$
Q	Chip volume	cm ³ /min	$Q = \frac{a_p \cdot a_e \cdot v_f}{1000}$
T	Milling time	min	$T = \frac{l_f}{v_f}$
hm	Average chip thickness	mm	$hm = f_z \cdot \sqrt{\frac{a_e}{D}}$
D_(eff)	Effective diameter 	mm	$D_{(eff)} = 2 \cdot \sqrt{D \cdot a_p - a_p^2}$
	Effective diameter with approach angle 	mm	$D_{(eff)} = D \cdot \sin \left[\beta + \arccos \left(\frac{D - 2a_p}{D} \right) \right]$
R_{th}	Peak-to-valley height	mm	$R_{th} = \frac{D}{2} = \sqrt{\frac{D^2 - a_e^2}{4}}$
Z_b	Optimal step over for torus milling	mm	$Z_b = \frac{D - 2 \times R}{2}$

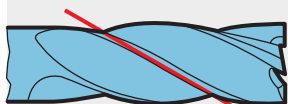

30°

Type N

Quick spiral with 30° helical pitch, suitable for finish milling structural, case hardened and heat-treatable steels as well as short-chipping non-ferrous metals and materials up to

- 1200 N/mm² tensile strength applying high speed steel milling cutters
- 1600 N/mm² tensile strength applying solid carbide milling cutters

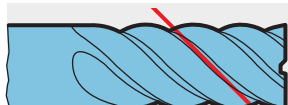

45°

Type NH

Quick spiral with high 45° helical pitch, suitable for super fine finishing high-alloyed materials and grey cast iron up to appr.

- 1600 N/mm² tensile strength

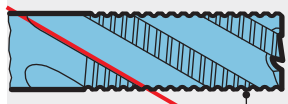

30°

Chip breaker-
geometry
flattened
coarse



Type NF

Flat knuckle-type teeth/quick spiral, produces short chips and improved smoother surface quality in comparison to type NR or NRf. Suitable for milling standard materials up to appr.

- 1200 N/mm² tensile strength applying high speed steel milling cutters
- 1600 N/mm² tensile strength applying solid carbide milling cutters

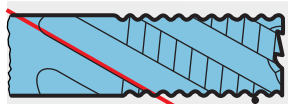

30°

Chip breaker-
geometry
coarse



Type NR

Standard knuckle-type teeth, produces short chips and good chip evacuation. Suitable for milling standard materials up to appr.

- 1000 N/mm² tensile strength applying high speed steel milling cutters
- 1200 N/mm² tensile strength applying solid carbide milling cutters

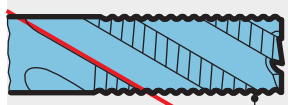

30°

Chip breaker-
geometry
fine



Type NRf

Fine knuckle-type teeth, produces short chips and good chip evacuation. Better feed rates possible than with type NR. Suitable for milling materials with a high tensile strength up to appr.

- 1400 N/mm² tensile strength applying high speed steel milling cutters
- 1600 N/mm² tensile strength applying solid carbide milling cutters

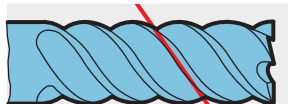

55°

Type H

Quick spiral with high 55° helical pitch, suitable for super-fine finishing as well as HSC* machining of all hardened materials and chilled cast iron up to appr.

- 62 HRC hardness

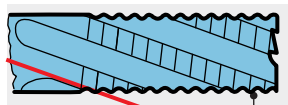

20°

Chip breaker-
geometry
fine



Type HR

Fine knuckle-type teeth, produces short chips with good chip evacuation. Suitable for milling hardened materials as well as grey and chilled cast iron with up to appr.

- 56 HRC hardness

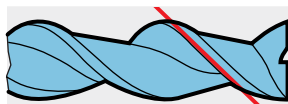

45°

Type W

Quick spiral with 45° helical pitch, suitable for finish milling soft materials such as aluminium, Al-alloys and non-ferrous metals up to appr.

- 600 N/mm² tensile strength

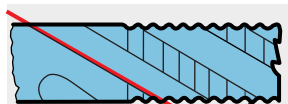

30°

Chip breaker-
geometry
extra coarse



Type WR

Coarse knuckle-type teeth, produces short chips with good chip evacuation. Suitable for milling aluminium, non-ferrous metals as well as soft steels up to appr.

- 600 N/mm² tensile strength.



	RF 100 U (type N)	35°/38° helix. Suitable for slotting, roughing and finishing steel, high-alloyed steel and hardened steel up to <ul style="list-style-type: none"> • 1600 N/mm² tensile strength (48 HRC)
	RF 100 U (type NH) 3-fluted	41°/43°/45° helix. Suitable for slotting, roughing and finishing steel, high-alloyed steel and stainless steel up to <ul style="list-style-type: none"> • 1400 N/mm² tensile strength (44 HRC) 3-fluted suitable for extreme cutting depths
	RF 100 U/HF (type HF)	30°/32° helix and roughing and finishing geometry. Suitable for slotting and roughing with large cutting widths and depths in steel, high-alloyed steel and hardened steel up to <ul style="list-style-type: none"> • 1600 N/mm² tensile strength (48 HRC)
	RF 100 F (type NH)	40°/42° helix. Suitable for slotting, roughing and finishing as well as HPC-milling/imachining tough steels as well as other long-chipping materials up to <ul style="list-style-type: none"> • 850 N/mm² tensile strength (25 HRC)
	RF 100 VA (type N)	36°/38° helix. Suitable for slotting, roughing and finishing VA steels and stainless materials
	RF 100 VA/NF (type NF)	36°/38° helix and roughing and finishing geometry. Suitable for slotting and roughing VA steels and stainless materials
	RF 100 A (type W)	39°/40°/41° helix. Suitable for slotting, roughing and finishing aluminium and Al-alloys as well as long-chipping materials and non-ferrous metals
	RF 100 A/WF (type WF)	29°/30°/31° helix and roughing and finishing geometry. Suitable for slotting and roughing aluminium and Al-alloys
	RF 100 H (type H)	40°/42° helix and progressive core diameter. Suitable for roughing up to 1xD in materials up to 54 HRC, for finishing over the entire cutting edge length in materials over 63 HRC. With HPC strategy suitable for roughing materials > 63 HRC.
	RF 100 Ti (type N)	35°/38° helix with corner radius. Suitable for slotting and roughing of titanium alloys as well as difficult-to-cut alloys
	RF 100 SF (type NH)	44°/45°/46° helix. Suitable for HSC super fine finishing for semi-roughing with feed widths up to max. 0.3xD and HPC roughing over the entire cutting edge length for standard steels, cast iron, non-ferrous metals and high-alloyed materials

Clamping chucks / tool holders for straight tool shanks	TSG 3000 / shrink fit chucks / shrink fit extensions	Hydraulic chucks / HMC 3000 / reduction bushes
		
Characteristics	maximum concentricity; very slender non-interference; good rigidity; high clamping force; modular lengthening; patented dampening screw ensures concentricity	high dampening with maximum concentricity; simple handling; flexible application thanks to reduction bushes also with GÜHROJET
Main application	drilling, countersinking, milling, reaming, universal and HSC applicatio	reaming, drilling, countersinking, HSC application, light milling
Main feature	accurate and universal; slender; high clamping force	simple handling
Concentricity	$< 3\mu\text{m}$	$< 3\mu\text{m}$
with 5xD	$< 5\mu\text{m}$	$< 5\mu\text{m}$
Clamping force	very high	very high
Rigidity	very high	high
Dampening	low	very high
Interference contour	small / minimal	medium
Handling	good	very good / very flexible
Actuation	shrink fit device e.g. GSS 2000 Art. no. 4742	hexagon key e.g. Art. no. 4912



HPC precision power chucks / clamping sleeves	Straight shank holders "Weldon" / "Whistle-Notch"	Collet chucks ER
		
<p>maximum clamping force and rigidity thanks to mechanical clamping transmission; high accuracy and balancing quality; flexible application thanks to clamping sleeves also with GÜHROJET</p>	<p>robust, cost-efficient clamping chuck for heavy machining in the lower speed and accuracy range</p>	<p>very flexible clamping chuck for various shank dimensions and tolerances; for lower level machining tasks</p>
<p>heavy HPC and fast accurate HSC milling, drilling, universal application</p>	<p>roughing, milling, drilling</p>	<p>light machining, centering, chamfering, drilling, threading; intermediate shank dimensions</p>
<p>highest clamping force and rigidity</p>	<p>simple operation; secure clamping</p>	<p>highly flexible</p>
<p>< 3µm</p>	<p>< 10µm</p>	<p>< 10µm</p>
<p>< 8µm</p>	<p>< 25µm</p>	<p>< 20µm</p>
<p>extremely high</p>	<p>very safe</p>	<p>medium</p>
<p>extremely high</p>	<p>very high</p>	<p>low</p>
<p>high</p>	<p>low</p>	<p>high</p>
<p>medium</p>	<p>large</p>	<p>large (mini = small)</p>
<p>very good / flexible</p>	<p>good</p>	<p>good</p>
<p>hexagon key / torque wrench e.g. Art. no. 4915 + 4916 Type D</p>	<p>hexagon key Torque: Information with clamping screw Art. no. 4903</p>	<p>hook spanner Max. torque: Information with clamping nut Art. no. 4903</p>

The new material abbreviations (selection)

mat. nos.	abbreviation old	abbreviation new	mat. nos.	abbreviation old	abbreviation new	mat. nos.	abbreviation old	abbreviation new	mat. nos.	abbreviation old	abbreviation new
0.6010	GG10	EN-GJL-100	1.0728	60 S 20	-	1.4436	X5CrNiMo17 133	X3CrNiMo17-13-3	1.7043	-	38Cr4
0.6020	GG20	EN-GJL-200	1.0736	9 SMn 36	11SMn37	1.4438	X2CrNiMo 18 16 4	X2CrNiMo18-15-4	1.7147	20 MnCr 5	20MnCr5
0.6025	GG25	EN-GJL-250	1.0737	9 SMnPb 36	11SMnPb37	1.4460	X4CrNiMo27 52	X3CrNiMoN27-5-2	1.7149	20 MnCrS 5	20MnCrS5
0.6035	GG35	EN-GJL-350	1.0756	35 SPb 20	35SPb20	1.4462	X2CrNiMoN22 53	X2CrNiMoN22-5-3	1.7176	55 Cr 3	55Cr3
0.7050	GGG50	EN-GJS-500-7	1.0757	45 SPb 20	46SPb20	1.4509	X6CrTiNb 18	X2CrTiNb18	1.7182	27 MnCrB 5 2	27MnCrB5-2
0.7070	GGG70	EN-GJS-700-2	1.0760	-	38SMn26	1.4510	X6CrTi 17	X3CrTi17	1.7185	33 MnCrB 5 2	33MnCrB5-2
0.8035	GTW35	EN-GJMW-350-4	1.0761	-	38SMnPb26	1.4511	X6CrNb 17	X3CrNb17	1.7189	39 MnCrB 6 2	39MnCrB6-2
0.8155	GT55	EN-GJMB-550-4	1.0762	-	44SMn28	1.4512	X6CrTi 12	X2CrTi12	1.7213	25 CrMoS 4	25CrMoS4
0.8170	GTS70	EN-GJMB-700-2	1.0763	-	44SMnPb28	1.4520	X1CrTi 15	X2CrTi17	1.7218	25 CrMo 4	25CrMo4
1.0022	St 01Z	-	1.0873	-	DC06 [Fe P06]	1.4521	X2CrMoTi 18 2	X2CrMoTi18-2	1.7219	-	26CrMo4-2
1.0035	St 33	S185	1.1103	ESiE 255	S255NL1	1.4522	X2CrMoNb 18 2	X2CrMoNb18-2	1.7220	34 CrMo 4	34CrMo4
1.0039	St 37 -2	S235JRH	1.1105	ESiE 315	S315NL1	1.4532	X7CrNiMoAl 15 7	X8CrNiMoAl15-7-2	1.7225	42 CrMo 4	42CrMo4
1.0044	St 44 -2	S275JR	1.1121	Ck 10	C10E	1.4541	X6CrNiTi18 10	X6CrNiTi18-10	1.7226	34 CrMoS 4	34CrMoS4
1.0050	St 50 -2	E295	1.1141	Ck15	C15E	1.4542	X5CrNiCuNb 17 4	X5CrNiCuNb16-4	1.7227	42 CrMo 4	42CrMo4
1.0060	St 60 -2	E335	1.1151	Ck 22	C22E	1.4550	X6CrNiNb 18 10	X6CrNiNb18-10	1.7228	50 CrMo 4	50CrMo4
1.0070	St 70 -2	E360	1.1158	Ck 25	C25E	1.4558	X2NiCrAlTi 32 20	X2NiCrAlTi32-20	1.7264	20 CrMo 5	20CrMo5
1.0114	St 37 -3U	S235J0	1.1170	28 Mn 6	28Mn6	1.4567	X3CrNiCu 18 9 X	X3CrNiCu18-9-4	1.7321	20 MoCr 4	20MoCr4
1.0226	St 02Z	DX51D	1.1178	Ck 30	C30E	1.4568	X7CrNiAl 17 7	X7CrNiAl17-7	1.7323	20 MoCrS 4	20MoCrS4
1.0242	StE 250 -2Z	S250GD	1.1181	Ck 35	C35E	1.4571	-	X6CrNiMoTi17-12-2	1.7333	22 CrMoS 3 5	22CrMoS3-5
1.0244	StE 280 -2Z	S280GD	1.1186	Ck 40	C40E	1.4577	X3CrNiMoTi 25 25	X3CrNiMoTi25-25	1.7335	13 CrMo 4 4	13CrMo4-5
1.0250	StE 320 -3Z	S320GD	1.1191	Ck 45	C45E	1.4592	X1CrMoTi 29 4	X2CrMoTi29-4	1.7362	12 CrMo 19 5	12CrMo19-5
1.0301	C 10	-	1.1203	Ck 55	C55E	1.4713	X10CrAl 7	X10CrAlSi7	1.7380	10 CrMo 9 10	10CrMo9-10
1.0302	C 10 Pb	-	1.1206	Ck 50	C50E	1.4724	X10CrAl 13	X10CrAlSi13	1.7383	-	11CrMo9-10
1.0306	St 06 Z	DX54D	1.1221	Ck 60	C60E	1.4742	X10CrAl 18	X10CrAlSi18	1.7779	-	20CrMoV13-5-5
1.0312	St 15	DC05 [Fe P05]	1.1241	Cm 50	C50R	1.4762	X10CrAl 24	X10CrAlSi25	1.8159	50 CrV 4	51CrV4
1.0319	RRStE 210.7	L210GA	1.1750	C 75 W	C75W	1.4821	X20CrNiSi 25 4	X20CrNiSi25-4	1.8504	34 CrAl 6	34CrAl6
1.0322	-	DX56D	1.2067	102 Cr 6	102Cr6	1.4828	X15CrNiSi 20 12	X15CrNiSi20-12	1.8519	31 CrMoV 9	31CrMoV9
1.0330	St 12 [St 2]	DC01 [Fe P01]	1.2080	-	X210Cr12	1.4833	X7CrNi 23 14	X7CrNi23-12	1.8550	34 CrAlNi 7	34CrAlNi7
1.0333	UST 13	-	1.2083	-	X42Cr13	1.4841	X15CrNiSi 25 20	X15CrNiSi25-21	1.8807	13 MnNiMoV 5 4	13MnNiMoV5-4
1.0338	St 14 [St 4]	DC04 [Fe P04]	1.2419	-	105WCr6	1.4845	X12CrNi 25 21	X12CrNi25-21	1.8812	18 MnMoV 5 2	18MnMoV5-2
1.0345	H I	P235GH	1.2767	-	X45NiCrMo4	1.4864	X12NiCrSi 36 16	X12NiCrSi35-16	1.8815	18 MnMoV 6 3	18MnMoV6-3
1.0347	RRSt 13 [RRSt 3]	DC03 [Fe P03]	1.3243	S6-5-2-5	S 6-5-2-5	1.4878	X12CrNiTi 18 9	X10CrNiTi18-10	1.8821	StE 355 TM	P355M
1.0348	UH I	P195GH	1.3343	S6-5-2	S 6-5-2	1.4903	-	X10CrMoVNi9-1	1.8824	StE 420 TM	P420M
1.0350	St 03Z	DX52D	1.3344	S6-5-3	S 6-5-3	1.5026	55 Si 7	55Si7	1.8826	StE 460 TM	P460M
1.0355	St 05Z	DX53D	1.4000	X6Cr 13	X6Cr13	1.5131	50 MnSi 4	50MnSi4	1.8828	ESTE 420 TM	P420ML2
1.0356	TTSt 35 N	P215NL	1.4002	X6CrAl 13	X6CrAl13	1.5415	15 Mo 3	16Mo3	1.8831	ESTE 460 TM	P460ML2
1.0358	St 05 Z	-	1.4003	X2Cr 11	X2CrNi12	1.5530	21 MnB 5	20MnB5	1.8832	TSiE 355 TM	P355ML1
1.0401	C 15	-	1.4005	-	X12CrS13	1.5531	30 MnB 5	30MnB5	1.8835	TSiE 420 TM	P420ML1
1.0402	C 22	C22	1.4006	X10Cr 13	X12Cr13	1.5532	38 MnB 5	38MnB5	1.8837	StE 460 TM	P460ML1
1.0403	C 15 Pb	-	1.4016	X6Cr 17	X6Cr17	1.5637	10 Ni 14	12Ni14	1.8879	StE ...	P690Q
1.0406	C 25	C25	1.4021	X20Cr 13	X20Cr13	1.5662	-	X11CrMo5+1	1.8880	WStE ...	P690QH
1.0419	St 52.0	L355	1.4028	X30Cr 13	X30Cr13	1.5680	-	X12Ni5	1.8881	TSiE ...	P690QL1
1.0424	St 45.8 (ersetzt)	P265	1.4031	X38Cr 13	X38Cr13	1.5710	36 NiCr 6	36NiCr6	1.8882	10 MnTi 3	10MnTi3
1.0424	St 42.8 (ersetzt)	P265	1.4034	X46Cr 13	X46Cr13	1.5715	-	16NiCrS4	1.8888	ESTE ...	P690QL2
1.0425	H2	P265GH	1.4037	X65Cr13	X65Cr13	1.5752	14 NiCr 14	15NiCr13	1.8900	StE 380	S380N
1.0429	StE 290.7 TM	L290MB	1.4057	X20CrNi 17 2	X17CrNi16-2	1.6210	15 MnNi 6 3	15MnNi6-3	1.8901	StE 460	S460N
1.0457	StE 240.7	L245NB	1.4104	X12CrMoS 17	X14CrMoS17	1.6211	16 MnNi 6 3	16MnNi6-3	1.8902	StE 420	S420N
1.0459	RRStE 240.7	L245GA	1.4105	X4CrMoS 18	X6CrMoS17	1.6310	20 MnMoNi 5 5	20MnMoNi5-5	1.8903	TSiE 460	S460NL
1.0461	StE 255	S255N	1.4109	X65CrMo 14	X70CrMo15	1.6311	20 MnMoNi 4 5	20MnMoNi4-5	1.8905	StE 460	P460N
1.0473	19 Mn 6	P355GH	1.4110	X55CrMo 14	X55CrMo14	1.6341	11 NiMoV 5 3	11NiMoV5-3	1.8907	StE 500	S500N
1.0481	17 Mn 4	P295GH	1.4112	X90CrMoV 18	X90CrMoV18	1.6368	15 NiCuMoNb 5	15NiCuMoNb5	1.8910	TSiE 380	S380NL
1.0484	StE 290.7	L290NB	1.4113	X6CrMo 17 1	X6CrMo17-1	1.6511	36 CrNiMo 4	36CrNiMo4	1.8911	ESTE 380	S380NL1
1.0486	StE 285	P275N	1.4116	X45CrMoV 15	X50CrMoV15	1.6523	21 NiCrMo 2	21NiCrMo2-2	1.8912	TSiE 420	S420NL
1.0501	C 35	C35	1.4120	X20CrMo 13	X20CrMo13	1.6526	21 NiCrMoS 2	21NiCrMoS2-2	1.8913	ESTE 420	S420NL1
1.0503	C 45	C45	1.4122	X35CrMo 17	X39CrMo17-1	1.6580	30 CrNiMo 8	30CrNiMo8	1.8915	TSiE 460	P460NL1
1.0505	StE 315	P315N	1.4125	X105CrMo 17	X105CrMo17	1.6582	34 CrNiMo 6	34CrNiMo6	1.8917	WStE 500	S500NL
1.0511	C 40	C40	1.4301	X5CrNi 18 10	X5CrNi18-10	1.6587	17 CrNiMo 6	18CrNiMo7-6	1.8918	ESTE 460	P460NL2
1.0528	C 30	C30	1.4303	X5CrNi 18 12	X4CrNi18-12	1.7003	38 Cr 2	38Cr2	1.8919	ESTE 500	S500NL1
1.0529	StE 350 -3Z	S350GD	1.4305	X10CrNiS 18 9	X8CrNiS18-9	1.7006	46 Cr 2	46Cr2	1.8930	WStE 380	P380NH
1.0535	C 55	C55	1.4306	X2CrNi 19 11	X2CrNi19-11	1.7016	17 Cr 3	17Cr3	1.8932	WStE 420	P420NH
1.0539	StE 355N	S355NH	1.4310	X12CrNi 17 7	X10CrNi18-8	1.7023	38 CrS 2	38CrS2	1.8935	WStE 460	P460NH
1.0540	C 50	C50	1.4311	X2CrNiN 18 10	X2CrNiN18-10	1.7025	46 CrS 2	46CrS2	1.8937	TSiE 500	P500NH
1.0547	St 52 -3U	S355J0H	1.4313	X4CrNi 13 4	X3CrNiMo13-4	1.7030	28 Cr 4	28Cr4	1.8972	StE 415.7	L415NB
1.0582	StE 360.7	L360NB	1.4318	X2CrNiN 18 7	X2CrNiN18-7	1.7033	34 Cr 4	34Cr4	1.8973	StE 415.7 TM	L415MB
1.0601	C 60	C60	1.4335	X1CrNi 25 21	X1CrNi25-21	1.7034	37 Cr 4	37Cr4	1.8975	StE 445.7 TM	L450MB
1.0710	15 S 10	-	1.4361	X1CrNiSi 18 15	X1CrNiSi18-15-4	1.7035	41 Cr 4	41Cr4	1.8977	StE 480.7 TM	L485MB
1.0715	9 SMn 28	11SMn30	1.4362	X2CrNiN 23 4	X2CrNiN23-4	1.7036	28 CrS 4	28CrS4	1.8978	StE 550.7 TM	L555MB
1.0718	9 SMnPb 28	11SMnPb30	1.4401	X5CrNiMo 17 122	X5CrNiMo17-12-2	1.7037	34 CrS 4	34CrS4			
1.0721	10 S 20	10S20	1.4404	X2CrNiMo 17 132	X2CrNiMo17-12-2	1.7038	37 CrS 4	37CrS4			
1.0722	10 S Pb 20	10SPb20	1.4410	X10CrNiMo 18 9	X2CrNiMoN25-7-4	1.7039	41 CrS 4	41CrS4			
1.0726	35 S 20	35S20	1.4418	X4CrNiMo 16 5	X4CrNiMo16-5-1	1.7131	16 MnCr 5	16MnCr5			
1.0727	45 S 20	46S20	1.4435	X2CrNiMo 18 143	X2CrNiMo18-14-3	1.7139	16 MnCrS 5	16MnCrS5			



Tens. strength (N/mm ²)	HRC	HB30	HV10
240		71	75
255		76	80
270		81	85
285		86	90
305		90	95
320		95	100
335		100	105
350		105	110
370		109	115
385		114	120
400		119	125
415		124	130
430		128	135
450		133	140
465		138	145
480		143	150
495		147	155
510		152	160
530		157	165
545		162	170
560		166	175
575		171	180
595		176	185
610		181	190
625		185	195
640		190	200
660		195	205
675		199	210
690		204	215
705		209	220
720		214	225
740		219	230
755		223	235
770		228	240
785		233	245
800	22	238	250
820	23	242	255
835	24	247	260
860	25	255	268
870	26	258	272
900	27	266	280
920	28	273	287
940	29	278	293
970	30	287	302
995	31	295	310
1020	32	301	317
1050	33	311	327
1080	34	319	336
1110	35	328	345
1140	36	337	355
1170	37	346	364

Tens. strength (N/mm ²)	HRC	HB30	HV10
1200	38	354	373
1230	39	363	382
1260	40	372	392
1300	41	383	403
1330	42	393	413
1360	43	402	423
1400	44	413	434
1440	45	424	446
1480	46	435	458
1530	47	449	473
1570	48	460	484
1620	49	472	497
1680	50	488	514
1730	51	501	527
1790	52	517	544
1845	53	532	560
1910	54	549	578
1980	55	567	596
2050	56	584	615
2140	57	607	639
2180	58	622	655
	59		675
	60		698
	61		720
	62		745
	63		773
	64		800
	65		829
	66		864
	67		900
	68		940



Customer number	New cust.	RFQ/P.O. Number
Company		Contact
Street	Postcode	Contact at Guhring
Telephone	Fax	
Date	Signature	

Enquiry Order

(Please enter the required parameters into the boxes)

Reference tool / basic tool (Art.-No.)

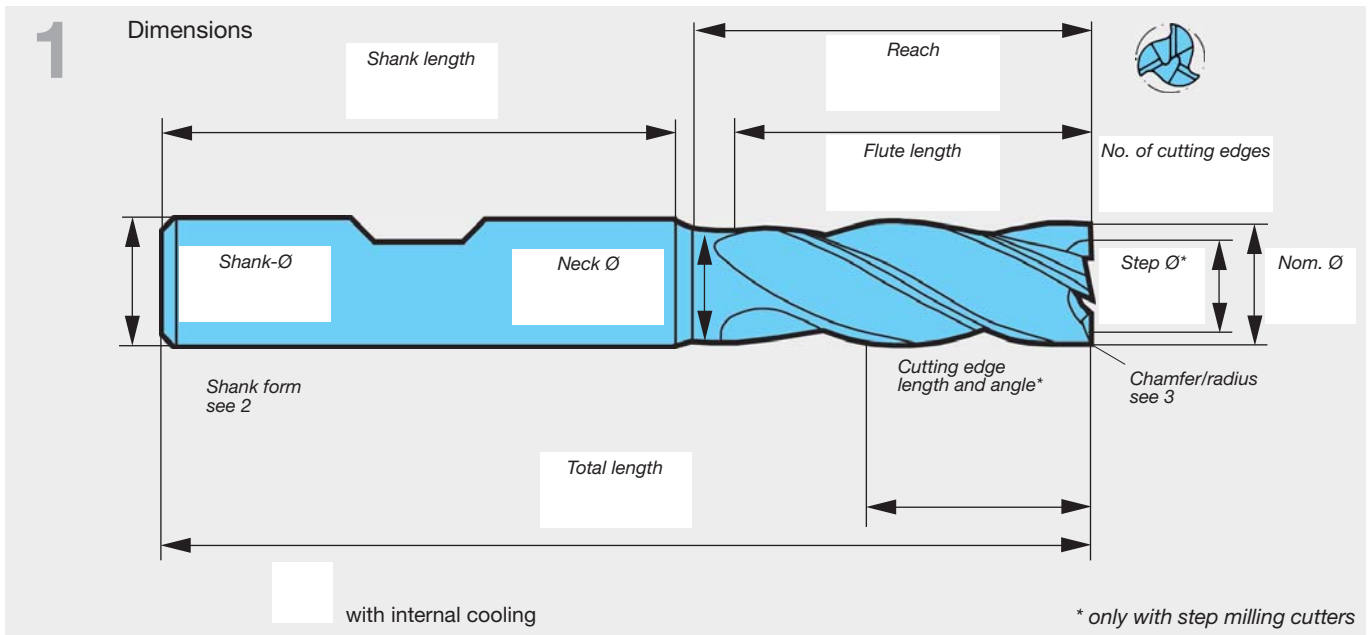

2 Shank form

Plain shank Flatted shank Whistle Notch

3 Chamfer/ radius

Chamfer Corner radius Ball nose Size

4 Geometry

Type N, W, H Type NF Type NRf, HR Type WR

5 Material Coating

Solid carbide HSS M42 HSS-E-PM other: _____

bright SuperA-coated A-coated FIRE-coated

6 Operation

Slotting Roughing Finishing Tracing

Depth of cut: _____
Width of cut: _____

7 Application

Workpiece material: _____

Hardness: _____

8 Required quantity: _____



P	M	K	N	S	H	Tool illustration	Z	Hardness	Shank form	Length	Helix angle °	Tool material	Surface	d1/mm	Article no.	Page
---	---	---	---	---	---	-------------------	---	----------	------------	--------	---------------	---------------	---------	-------	-------------	------

Standard Ratio end mills RF 100 U (3-fluted)

•	•	•	•	•	•			HA			41° 43° 45°	VHM	F	3.000 - 16.000	3893	15
•	•	•	•	•	•			HB			41° 43° 45°	VHM	F	3.000 - 16.000	3894	15
•	•	•	•	•	•			HA			41° 43° 45°	VHM	F	3.000 - 20.000	3891	16
•	•	•	•	•	•			HB			41° 43° 45°	VHM	F	3.000 - 20.000	3892	16

Slot drills GH 100 U (3-fluted)

•	•	•	•	•	•			-HA			45°	VHM	○	2.000 - 20.000	3203	17
•	•	•	•	•	•			-HA			45°	VHM	F	2.000 - 20.000	3741	17
•	•	•	•	•	•			HA			45°	VHM	○	3.000 - 20.000	3193	18
•	•	•	•	•	•			HA			45°	VHM	F	3.000 - 20.000	3540	18
•	•	•	•	•	•			HB			45°	VHM	F	3.000 - 20.000	3729	19
•	•	•	•	•	•			HA			45°	VHM	○	1.000 - 20.000	3196	20
•	•	•	•	•	•			HA			45°	VHM	F	1.000 - 20.000	3636	20
•	•	•	•	•	•			HB			45°	VHM	F	3.000 - 20.000	3730	21

Pilot end mills RF 100 P

•	•	•	•	•	•			48 HRC	HA			30°	VHM	A	1.400 - 12.000	6716	22
---	---	---	---	---	---	--	--	--------	----	--	--	-----	-----	---	----------------	------	----

Ratio end mills RF 100 DIVER (3-fluted)

•	•	•	•	•	•			HA			41° 43° 45°	VHM	Y	3.000 - 20.000	6797	24
•	•	•	•	•	•			HB			41° 43° 45°	VHM	Y	3.000 - 20.000	6798	24

Ratio end mills RF 100 DIVER

•	•	•	•	•	•			48 HRC	HA			36° 38° 37°	VHM	Y	3.000 - 20.000	6803	25
•	•	•	•	•	•			48 HRC	HB			36° 38° 37°	VHM	Y	3.000 - 20.000	6804	25
•	•	•	•	•	•			48 HRC	HA			36° 38° 37°	VHM	Y	4.000 - 20.000	6737	26
•	•	•	•	•	•			48 HRC	HB			36° 38° 37°	VHM	Y	4.000 - 20.000	6736	26

Ratio end mills RF 100 F

•	•	•	•	•	•			HA			40° 42°	VHM	F	4.000 - 20.000	3629	27
---	---	---	---	---	---	--	--	----	--	--	------------	-----	---	----------------	------	----

Steel, cast iron and hardened steel

P	M	K	N	S	H	Tool illustration	Z	Hardness	Shank form	Length	Helix angle °	Tool material	Surface	d1/mm	Article no.	Page
Ratio end mills RF 100 F																
•	•	○	•				4		HB		40° 42°	VHM	F	4.000 - 20.000	3630	27
•	•	○	•				4		HB		40° 42°	VHM	F	6.000 - 20.000	3366	28
•	•	○	•				4		HA		40° 42°	VHM	a	3.000 - 20.000	6764	29
Ratio end mills RF 100 Speed																
•	•		•				4		HA		48°	VHM	A	3.000 - 20.000	6765	31
•	•		•				4		HB		48°	VHM	A	3.000 - 20.000	6760	31
•	•		•				4		HA		48°	VHM	A	3.000 - 20.000	6766	32
•	•		•				4		HB		48°	VHM	A	3.000 - 20.000	6761	32
Standard Ratio end mills RF 100 U																
•	•		○				4	48 HRC	HA		35° 38°	VHM	F	3.000 - 20.000	6706	33
•	•		○				4	48 HRC	HB		35° 38°	VHM	F	3.000 - 20.000	3731	33
•	•		○				4		HB		35° 38°	VHM	○	6.000 - 20.000	3200	34
•	•		○				4	48 HRC	HA		35° 38°	VHM	F	3.000 - 25.000	3736	35
•	•		○				4	48 HRC	HB		35° 38°	VHM	F	3.000 - 25.000	3732	35
•	•		○				4		HA		35° 38°	VHM	○	4.000 - 25.000	3208	36
•	•		○				4		HB		35° 38°	VHM	○	4.000 - 25.000	3201	36
•	○		•				4	48 HRC	HB		35° 38°	VHM	R	6.000 - 20.000	6726	37
•	•		○				4	48 HRC	HA		35° 38°	VHM	F	6.000 - 20.000	3837	38
•	•		○				4	48 HRC	HB		35° 38°	VHM	F	6.000 - 20.000	3838	38
•	•		○				4	48 HRC	HA	3xD	35° 38°	VHM	F	6.000 - 20.000	3839	39
•	•		○				4	48 HRC	HB	3xD	35° 38°	VHM	F	6.000 - 20.000	3871	39
•	•		○				4		-HA		35° 38°	VHM	○	10.000 - 25.000	3209	40
•	•		○				4	48 HRC	-HA		35° 38°	VHM	F	10.000 - 25.000	3627	40
•	•		○				4	48 HRC	HA	4xD	38°	VHM	F	6.000 - 25.000	6767	41
•	•		○				4	48 HRC	HB	4xD	38°	VHM	F	6.000 - 25.000	6768	41



P	M	K	N	S	H	Tool illustration	Z	Hardness	Shank form	Length	Helix angle °	Tool material	Surface	d1/mm	Article no.	Page
Standard Ratio end mills RF 100 U																
•	•				○		4	48 HRC	HA		35° 38°	VHM	F	6.000 - 25.000	3872	42
•	•				○		4	48 HRC	HB		35° 38°	VHM	F	6.000 - 25.000	3873	42
Standard Ratio end mills RF 100 U																
•	•						4		HA		30° 32°	VHM	F	6.000 - 25.000	6881	44
•	•						4		HB		30° 32°	VHM	F	6.000 - 25.000	6882	44
•	•						4		HA	3xD	30° 32°	VHM	F	6.000 - 20.000	6883	45
•	•						4		HB	3xD	30° 32°	VHM	F	6.000 - 20.000	6884	45
•	•						4		-HA		30° 32°	VHM	F	6.000 - 20.000	6885	46
•	•						4		-HB		30° 32°	VHM	F	6.000 - 20.000	6886	46
High-performance roughing end mills RS 100 U																
•	•	•	○	•			4-5		HA		30°	VHM	F	6.000 - 25.000	6887	47
•	•	•	○	•			4-5		HB		30°	VHM	F	6.000 - 25.000	6888	47
High-performance roughing end mills RS 100 F																
•	•				○		5-6	48 HRC	HA		45°	VHM	F	6.000 - 25.000	6889	48
•	•				○		5-6	48 HRC	HB		45°	VHM	F	6.000 - 25.000	6890	48
Roughing end mills GS 100 U (fine teeth)																
•	•	•	○	○			4-5		HB		30°	VHM	○	6.000 - 25.000	3204	49
•	•	•	○	○			4-5		HB		30°	VHM	F	6.000 - 25.000	3723	49
•	•	•	○	○			4		HB		30°	VHM	F	6.000 - 20.000	3365	50
Ratio end mills Superfinish RF 100 SF																
•	•	•	•	○			5	48 HRC	HA		45°	VHM	F	4.000 - 25.000	6709	52
•	•	•	•	○			5	48 HRC	HB		45°	VHM	F	4.000 - 25.000	6710	52
•	•	•	•	○			6	48 HRC	HA		44° 45° 46°	VHM	F	8.000 - 25.000	3631	53
•	•	•	•	○			6	48 HRC	HB		44° 45° 46°	VHM	F	8.000 - 25.000	3632	53
•	•	•	•	○			5	48 HRC	HA	3xD	45°	VHM	F	4.000 - 20.000	3897	54

Steel, cast iron and hardened steel

P	M	K	N	S	H	Tool illustration	Z	Hardness	Shank form	Length	Helix angle °	Tool material	Surface	d1/mm	Article no.	Page
Ratio end mills Superfinish RF 100 SF																
•	•	•	•	•	•		5	48 HRC	HB	3xD	45°	VHM	F	4.000 - 20.000	3898	54
•	•	•	•	•	•		5		HA	3xD	45°	VHM	a	4.000 - 20.000	6763	55
Multi-tooth end mills GH 100 U																
•	•	•	•	•	○		6+	48 HRC	HA		45°	VHM	○	3.000 - 25.000	3311	56
•	•	•	•	•	○		6+	48 HRC	HA		45°	VHM	F	3.000 - 25.000	3689	56
•	•	•	•	•	○		6+	48 HRC	HB		45°	VHM	F	6.000 - 32.000	3047	57
•	•	•	•	•	○		6+		HA		45°	VHM	○	6.000 - 25.000	3312	58
•	•	•	•	•	○		6+	48 HRC	HA		45°	VHM	F	6.000 - 25.000	3691	58
•	•	•	•	•	○		6+		HB		45°	VHM	○	4.000 - 32.000	3313	59
•	•	•	•	•	○		6+	48 HRC	HB		45°	VHM	F	4.000 - 32.000	3693	59
Ratio end mills RF 100 H																
○	•	•	•	•	•		4	63 HRC	HA		40°/42°	VHM	Y	6.000 - 20.000	3895	61
○	•	•	•	•	•		4	63 HRC	HB		40°/42°	VHM	Y	6.000 - 20.000	3896	61
Hard profile cutters with Torus grind GF 300 T																
○	•	•	•	•	•		4	63 HRC	HA		30°	VHM	Y	1.000 - 16.000	3361	62
○	•	•	•	•	•		4	63 HRC	HA		30°	VHM	Y	1.000 - 16.000	3362	63
Hard roughing end mills GS 100 H (fine teeth)																
•	•	•	•	•	•		4	55 HRC	HA		20°	VHM	Y	6.000 - 25.000	6704	64
•	•	•	•	•	•		4	55 HRC	HB		20°	VHM	Y	6.000 - 25.000	6705	64
•	•	•	•	•	•		4	55 HRC	HB		20°	VHM	Y	6.000 - 20.000	3682	65
Hard multi-tooth end mills corner radius GH 100 H																
○	•	•	•	•	•		6	63 HRC	HA		55°	VHM	Y	3.000 - 16.000	4270	66
○	•	•	•	•	•		6+	63 HRC	HA		55°	VHM	Y	3.000 - 20.000	3715	67
○	•	•	•	•	•		6+	63 HRC	HA		55°	VHM	Y	6.000 - 20.000	3716	68



P	M	K	N	S	H	Tool illustration	Z	Hardness	Shank form	Length	Helix angle °	Tool material	Surface	d1/mm	Article no.	Page
---	---	---	---	---	---	-------------------	---	----------	------------	--------	---------------	---------------	---------	-------	-------------	------

Standard Ratio end mills RF 100 U (3-fluted)

•	•	•	•	•	•		3		HA			VHM	F	3.000 - 16.000	3893	74
•	•	•	•	•	•		3		HB			VHM	F	3.000 - 16.000	3894	74
•	•	•	•	•	•		3		HA			VHM	F	3.000 - 20.000	3891	75
•	•	•	•	•	•		3		HB			VHM	F	3.000 - 20.000	3892	75

Standard Ratio end mills RF 100 U (3-fluted)

•	•	•	•	•	•		3		HB			VHM	R	3.000 - 20.000	6728	77
---	---	---	---	---	---	--	---	--	----	--	--	-----	---	----------------	------	----

Ratio end mills RF 100 VA

•	•	•	•	•	•		4		HA			VHM	a	4.000 - 20.000	3804	79
•	•	•	•	•	•		4		HB			VHM	a	4.000 - 20.000	3805	79
•	•	•	•	•	•		4		HA			VHM	a	3.000 - 25.000	3800	80
•	•	•	•	•	•		4		HB			VHM	a	3.000 - 25.000	3803	80
•	•	•	•	•	•		4		HA			VHM	a	6.000 - 25.000	6700	81
•	•	•	•	•	•		4		HB			VHM	a	6.000 - 25.000	6701	81
•	•	•	•	•	•		4		HA			VHM	a	6.000 - 20.000	3806	82
•	•	•	•	•	•		4		HB			VHM	a	6.000 - 20.000	3807	82
•	•	•	•	•	•		4	48 HRC	HA			VHM	a	4.000 - 25.000	6707	83
•	•	•	•	•	•		4	48 HRC	HB			VHM	a	4.000 - 25.000	6708	83
•	•	•	•	•	•		4		HA			VHM	a	5.000 - 25.000	6877	84
•	•	•	•	•	•		4		HB			VHM	a	5.000 - 25.000	6878	84
•	•	•	•	•	•		4		HA			VHM	a	6.000 - 20.000	6879	85
•	•	•	•	•	•		4		HB			VHM	a	6.000 - 20.000	6880	85

Pilot end mills RF 100 P

•	•	•	•	•	•		4	48 HRC	HA			VHM	A	1.400 - 12.000	6716	87
---	---	---	---	---	---	--	---	--------	----	--	--	-----	---	----------------	------	----

Ratio end mills RF 100 DIVER (3-fluted)

•	•	•	•	•	•		3		HA			VHM	Y	3.000 - 20.000	6797	88
---	---	---	---	---	---	--	---	--	----	--	--	-----	---	----------------	------	----

Stainless steel and difficult-to-machine alloys

P	M	K	N	S	H	Tool illustration	Z	Hardness	Shank form	Length	Helix angle °	Tool material	Surface	d1/mm	Article no.	Page
Ratio end mills RF 100 DIVER (3-fluted)																
•	•	•	•	•	•				HB		41° 43° 45°	VHM	Y	3.000 - 20.000	6798	88
•	•	•	•	•	•				HA		41° 43° 45°	VHM	Y	6.000 - 16.000	6799	89
•	•	•	•	•	•				HB		41° 43° 45°	VHM	Y	6.000 - 16.000	6800	89
Ratio end mills RF 100 DIVER																
•	•	•	•	•	○			48 HRC	HA		36° 38° 37°	VHM	Y	3.000 - 20.000	6803	90
•	•	•	•	•	○			48 HRC	HB		36° 38° 37°	VHM	Y	3.000 - 20.000	6804	90
•	•	•	•	•	○			48 HRC	HA		36° 38° 37°	VHM	Y	4.000 - 20.000	6737	91
•	•	•	•	•	○			48 HRC	HB		36° 38° 37°	VHM	Y	4.000 - 20.000	6736	91
•	•	•	•	•	○			48 HRC	HA		36° 38° 37°	VHM	Y	6.000 - 25.000	6801	92
•	•	•	•	•	○			48 HRC	HB		36° 38° 37°	VHM	Y	6.000 - 25.000	6802	92
Ratio end mills RF 100 F																
•	•	○	•	•	•				HA		40° 42°	VHM	F	4.000 - 20.000	3629	93
•	•	○	•	•	•				HB		40° 42°	VHM	F	4.000 - 20.000	3630	93
•	•	○	•	•	•				HB		40° 42°	VHM	F	6.000 - 20.000	3366	94
•	•	○	•	•	•				HA		40° 42°	VHM	A	3.000 - 20.000	6764	95
Ratio end mills RF 100 Speed																
•	•	•	•	•	•				HA		48°	VHM	A	3.000 - 20.000	6765	97
•	•	•	•	•	•				HB		48°	VHM	A	3.000 - 20.000	6760	97
•	•	•	•	•	•				HA		48°	VHM	A	3.000 - 20.000	6766	98
•	•	•	•	•	•				HB		48°	VHM	A	3.000 - 20.000	6761	98
Ratio end mills RF 100 Ti																
•	•	•	•	•	○			48 HRC	HA		35° 38°	VHM	A	6.000 - 25.000	3498	100
•	•	•	•	•	○			48 HRC	HB		35° 38°	VHM	A	6.000 - 25.000	3499	100



P	M	K	N	S	H	Tool illustration	Z	Hardness	Shank form	Length	Helix angle °	Tool material	Surface	d1/mm	Article no.	Page
Standard Ratio end mills RF 100 U																
•	○						4	48 HRC	HB		35° 38°	VHM	Ⓡ	6.000 - 20.000	6726	102
High-performance roughing end mills RS 100 U																
•	•	•	○	•			4-5		HA		30°	VHM	Ⓡ	6.000 - 25.000	6887	103
•	•	•	○	•			4-5		HB		30°	VHM	Ⓡ	6.000 - 25.000	6888	103
Roughing end mills GS 100 U (fine teeth)																
•	•	•	○	○			4-5		HB		30°	VHM	○	6.000 - 25.000	3204	104
•	•	•	○	○			4-5		HB		30°	VHM	Ⓡ	6.000 - 25.000	3723	104
•	•	•	○	○			4		HB		30°	VHM	Ⓡ	6.000 - 20.000	3365	105
Ratio end mills Superfinish RF 100 SF																
•	•	•	•	•			6		HB		44° 45° 46°	VHM	Ⓡ	8.000 - 20.000	6727	107
•	•	•	•	•	○		5	48 HRC	HA		45°	VHM	Ⓡ	4.000 - 25.000	6709	108
•	•	•	•	•	○		5	48 HRC	HB		45°	VHM	Ⓡ	4.000 - 25.000	6710	108
•	•	•	•	•	○		6	48 HRC	HA		44° 45° 46°	VHM	Ⓡ	8.000 - 25.000	3631	109
•	•	•	•	•	○		6	48 HRC	HB		44° 45° 46°	VHM	Ⓡ	8.000 - 25.000	3632	109
•	•	•	•	•	○		5	48 HRC	HA	3xD	45°	VHM	Ⓡ	4.000 - 20.000	3897	110
•	•	•	•	•			5	48 HRC	HB	3xD	45°	VHM	Ⓡ	4.000 - 20.000	3898	110
•	•	•	•	•			5		HA	3xD	45°	VHM	Ⓡ	4.000 - 20.000	6763	111

Stainless steel and difficult-to-machine alloys

P	M	K	N	S	H	Tool illustration	Z	Hardness	Shank form	Length	Helix angle °	Tool material	Surface	d1/mm	Article no.	Page
---	---	---	---	---	---	-------------------	---	----------	------------	--------	---------------	---------------	---------	-------	-------------	------

Ratio end mills Alu RF 100 A

•							3	HA			39° 40° 41°	VHM	○	3.000 - 20.000	3472	117
•							3	HB			39° 40° 41°	VHM	○	3.000 - 20.000	6702	117
•							3	HA			39° 40° 41°	VHM	○	6.000 - 25.000	3599	118
•							3	HB			39° 40° 41°	VHM	○	6.000 - 25.000	6729	118
•							3	HA			39° 40° 41°	VHM	○	6.000 - 20.000	3473	119
•							3	HB			39° 40° 41°	VHM	○	6.000 - 20.000	6703	119
•							3	HA	3xD		39° 40° 41°	VHM	○	5.000 - 20.000	6730	120
•							3	HB	3xD		39° 40° 41°	VHM	○	5.000 - 20.000	6731	120
•							3	HA	4xD		39° 40° 41°	VHM	○	6.000 - 20.000	6732	121
•							3	HB	4xD		39° 40° 41°	VHM	○	6.000 - 20.000	6733	121
•							3	HA	5xD		39° 40° 41°	VHM	○	6.000 - 20.000	6734	122
•							3	HB	5xD		39° 40° 41°	VHM	○	6.000 - 20.000	6735	122
○	•	○					4	HA			40° 42°	VHM	○	4.000 - 20.000	3202	123
○	•	○					4	HB			40° 42°	VHM	○	4.000 - 20.000	3319	123
•							4	HA			40° 42°	VHM	○	3.000 - 20.000	6762	124
•							3	HA			30° 29° 31°	VHM	○	6.000 - 25.000	6868	125
•							3	HB			30° 29° 31°	VHM	○	6.000 - 25.000	6869	125
•							3	HA			30° 29° 31°	VHM	○	6.000 - 20.000	6870	126
•							3	HB			30° 29° 31°	VHM	○	6.000 - 20.000	6871	126

Slot drills GA 200 A (3-fluted)

•							3	HA			45°	VHM	○	6.000 - 25.000	3367	127
---	--	--	--	--	--	--	---	----	--	--	-----	-----	---	----------------	------	-----

End mills (single-fluted)

•							1	HA			30°	VHM	○	2.000 - 16.000	6793	128
---	--	--	--	--	--	--	---	----	--	--	-----	-----	---	----------------	------	-----

Al slot drills (2-fluted)

•							2	HA			45°	VHM	○	3.000 - 20.000	3310	129
---	--	--	--	--	--	--	---	----	--	--	-----	-----	---	----------------	------	-----

Aluminum, non-ferrous metals and plastics



P	M	K	N	S	H	Tool illustration	Z	Hardness	Shank form	Length	Helix angle °	Tool material	Surface	d1/mm	Article no.	Page
---	---	---	---	---	---	-------------------	---	----------	------------	--------	---------------	---------------	---------	-------	-------------	------

Al slot drills (2-fluted)

								HB			45°	VHM	○	3.000 - 20.000	3126	129
								HA			45°	VHM	○	3.000 - 20.000	3309	130
								HB			45°	VHM	○	3.000 - 20.000	3059	130

XL Al slot drills (2-fluted)

								HA			45°	VHM	○	5.000 - 16.000	3358	131
--	--	--	--	--	--	--	--	----	--	--	-----	-----	---	----------------	------	-----

Roughing end mills GS 100 A (coarse teeth)

								HB			30°	VHM	○	6.000 - 25.000	3364	132
								HB			30°	VHM	○	6.000 - 25.000	3127	132

Ratio end mills Superfinish RF 100 SF

								48 HRC	HA		45°	VHM	Ⓡ	4.000 - 25.000	6709	133
								48 HRC	HB		45°	VHM	Ⓡ	4.000 - 25.000	6710	133
								48 HRC	HA		44° 45° 46°	VHM	Ⓡ	8.000 - 25.000	3631	134
								48 HRC	HB		44° 45° 46°	VHM	Ⓡ	8.000 - 25.000	3632	134
								48 HRC	HA	3xD	45°	VHM	Ⓡ	4.000 - 20.000	3897	135
								48 HRC	HB	3xD	45°	VHM	Ⓡ	4.000 - 20.000	3898	135
								HA	3xD	45°	45°	VHM	Ⓡ	4.000 - 20.000	6763	136

Aluminum, non-ferrous metals and plastics

P	M	K	N	S	H	Tool illustration	Z	Hardness	Shank form	Length	Helix angle °	Tool material	Surface	d1/mm	Article no.	Page
						Slot drills XL (3-fluted)										
•							3	HA			30°	VHM	⊙	3.000 - 16.000	6721	143
						Slot drills with corner radius (2-fluted)										
•							2	HA			30°	VHM	⊙	6.000 - 12.000	6722	144
						End mills with corner radius (4-fluted)										
•							4	HA			30°	VHM	⊙	6.000 - 12.000	6723	145
						Ball nose slot drills (2-fluted)										
•							2	HA			30°	VHM	⊙	3.000 - 12.000	6724	146
						Ball nose end mills (4-fluted)										
•							4	HA			30°	VHM	⊙	3.000 - 12.000	6725	147
						Kevlar end mills FR 100										
							4-8	-HA			0°	VHM	⊙	4.000 - 12.700	6769	149
							4-8	-HA			0°	VHM	⊙	4.000 - 12.700	6770	150
						Kevlar end mills CR 100										
							6+	HA			0°	VHM	⊙	4.000 - 16.000	6720	152
							6+	HA			0°	VHM	⊙	4.000 - 16.000	6717	153
							6+	HA			0°	VHM	⊙	4.000 - 16.000	6719	154
						Kevlar end mills with internal cooling CR 100 Air										
							6+	HA			0°	VHM	⊙	6.000 - 16.000	6718	155
						PCD slot drills (2-fluted)										
•							2	HA			2-4°	PKD	○	4.000 - 20.000	5492	157
•							2	HA			2-4°	PKD	○	4.000 - 20.000	5493	158
						PCD slot drills (3-fluted)										
•							3	HA			4°	PKD	○	14.000 - 20.000	5495	159
•							3	Cyl			4°	PKD	○	14.000 - 20.000	5496	160

Diamond/PCD milling cutters



P	M	K	N	S	H	Tool illustration	Z	Hardness	Shank form	Length	Helix angle °	Tool material	Surface	d1/mm	Article no.	Page
---	---	---	---	---	---	-------------------	---	----------	------------	--------	---------------	---------------	---------	-------	-------------	------

HSC face milling cutters

							32.000 - 125.000	3016	162
--	--	--	--	--	--	--	------------------	-------------	-----

HSC face milling cutters

							63.000 - 250.000	4201	164
--	--	--	--	--	--	--	------------------	-------------	-----

PCD cartridges HSC

							30.000 - 30.300	4204	165
--	--	--	--	--	--	--	-----------------	-------------	-----

Coolant distributor

								4203	166
--	--	--	--	--	--	--	--	-------------	-----

Diamond/PCD milling cutters

P	M	K	N	S	H	Tool illustration	Z	Hardness	Shank form	Length	Helix angle °	Tool material	Surface	d1/mm	Article no.	Page
Slot drills with corner radius (2-fluted)																
•	•	•	•	•			2		HA		30°	VHM	○	6.000 - 20.000	3106	176
•	•	•	•	•			2	48 HRC	HA		30°	VHM	⊙	6.000 - 20.000	3561	176
End mills with corner radius (4-fluted)																
•	•	•	•	•	○		4		HA		30°	VHM	○	6.000 - 20.000	3111	177
•	•	•	•	•	○		4	48 HRC	HA		30°	VHM	⊙	6.000 - 20.000	3562	177
Multi-tooth end mills with corner radius GH 100 U																
•	•	•	•	•	○		6+	55 HRC	HA		45°	VHM	⊙	6.000 - 20.000	3563	178
HSC Torus end mills GF 500 T																
•	•	•	•	•	○		2	55 HRC	-HA		30°	VHM	⊙	4.000 - 12.000	3863	179
•	•	•	•	•	○		2	55 HRC	HA		30°	VHM	⊙	0.500 - 12.000	3856	180
•	•	•	•	•	○		2	55 HRC	-HA		30°	VHM	⊙	0.500 - 12.000	3865	181
•	•	•	•	•	○		2	55 HRC	-HA		30°	VHM	⊙	2.000 - 12.000	3859	182
•	•	•	•	•	○		2	55 HRC	-HA		30°	VHM	⊙	2.000 - 8.000	3860	183
•	•	•	•	•	○		4	55 HRC	HA		30°	VHM	⊙	3.000 - 12.000	4268	184
•	•	•	•	•	○		4	55 HRC	Cyl		30°	VHM	⊙	3.000 - 16.000	4269	185
HSC end mills High Feed HF 300																
•	•	•	•	•	○		4	55 HRC	HA		30°	VHM	⊙	3.000 - 16.000	6771	186
•	•	•	•	•	○		4	55 HRC	HA		30°	VHM	⊙	3.000 - 16.000	6772	187
Hard profile cutters with Torus grind GF 300 T																
○	•	•	•	•	•		4	63 HRC	HA		30°	VHM	⊙	1.000 - 16.000	3361	188
○	•	•	•	•	•		4	63 HRC	HA		30°	VHM	⊙	1.000 - 16.000	3362	189
Hard multi-tooth end mills corner radius GH 100 H																
○	•	•	•	•	•		6	63 HRC	HA		55°	VHM	⊙	3.000 - 12.000	4270	190
○	•	•	•	•	•		6	63 HRC	HA		55°	VHM	⊙	6.000 - 16.000	3363	191
Ball nose slot drills (2-fluted)																
•	•	•	•	•	○		2	48 HRC	HA		30°	VHM	⊙	0.500 - 20.000	3679	192

Solid carbide HSC radius milling cutters



P	M	K	N	S	H	Tool illustration	Z	Hardness	Shank form	Length	Helix angle °	Tool material	Surface	d1/mm	Article no.	Page
Ball nose slot drills (2-fluted)																
•	•	•	•	•	○		2	48 HRC	HB		30°	VHM	F	0.500 - 20.000	3049	192
•	•	•	•	•	○		2		HB		30°	VHM	○	3.000 - 20.000	3024	193
•	•	•	•	•	○		2		HA		30°	VHM	○	0.500 - 20.000	3308	194
Ball nose end mills (4-fluted)																
•	○	○	○	○	○		4		HA		30°	VHM	○	4.000 - 20.000	3306	195
•	○	○	○	○	○		4	48 HRC	HA		30°	VHM	F	4.000 - 20.000	3727	195
•	○	○	○	○	○		4		HB		30°	VHM	○	3.000 - 20.000	3026	196
•	○	○	○	○	○		4	48 HRC	HB		30°	VHM	F	3.000 - 20.000	3050	196
XL ball nose slot drills (2-fluted)																
•	•	•	•	•	○		2		HA		30°	VHM	○	3.000 - 12.000	3014	197
•	•	•	•	•	○		2	48 HRC	HA		30°	VHM	F	3.000 - 12.000	3030	197
XL ball nose end mills (4-fluted)																
•	○	○	○	○	○		4		HA		30°	VHM	○	3.000 - 12.000	3015	198
•	○	○	○	○	○		4	48 HRC	HA		30°	VHM	F	3.000 - 12.000	3043	198
HSC-ball nose end mills GF 500 B																
•	•	•	○	○	•		2	55 HRC	-HA		30°	VHM	Y	6.000 - 12.000	3854	199
•	•	•	○	○	•		2	55 HRC	-HA		30°	VHM	Y	4.000 - 12.000	3866	200
•	•	•	○	○	•		2	55 HRC	-HA		30°	VHM	Y	2.000 - 12.000	3848	201
•	•	•	○	○	•		2	55 HRC	Cyl		30°	VHM	Y	6.000 - 12.000	3855	202
•	•	•	○	○	•		2	55 HRC	-HA		30°	VHM	Y	2.000 - 12.000	3849	203
•	•	•	○	○	•		2	55 HRC	-HA		30°	VHM	Y	2.000 - 8.000	3853	204
•	•	•	○	○	•		4	55 HRC	HA		30°	VHM	Y	2.000 - 12.000	4248	205
•	•	•	○	○	•		4	55 HRC	Cyl		30°	VHM	Y	2.000 - 12.000	4249	206
Ball nose end mills GF 200 B																
•	•	•	○	○	•		4	48 HRC	HA		30°	VHM	F	3.000 - 10.000	3045	207

Solid carbide HSC radius milling cutters

P	M	K	N	S	H	Tool illustration	Z	Hardness	Shank form	Length	Helix angle °	Tool material	Surface	d1/mm	Article no.	Page
Ball nose end mills GF 200 B							2	63 HRC	HA		0°	VHM	F	3.000 - 10.000	3044	208
Ball nose hard profile cutters GF 300 B							2	63 HRC	HA		30°	VHM	Y	0.500 - 16.000	3359	209
							2	63 HRC	HA		30°	VHM	Y	3.000 - 16.000	3360	210
							4	63 HRC	HA		30°	VHM	Y	2.000 - 12.000	4246	211
							4	63 HRC	Cyl		30°	VHM	Y	2.000 - 12.000	4247	212
Die sinking cutter holder GF 200 WP							2		HA		0°		Ni	10.000 - 32.000	1941	213
							2		HA		0°		Ni	10.000 - 25.000	1942	214
Indexable inserts round							2	55 HRC				Cermet	○	10.000 - 32.000	1947	215
							2	55 HRC				VHM	F	10.000 - 32.000	2520	215
Clamping screws for diesinking cutter holders														3.000	1691	216
Torx screwdriver															1612	216

Solid carbide HSC radius milling cutters



P	M	K	N	S	H	Tool illustration	Z	Hardness	Shank form	Length	Helix angle °	Tool material	Surface	d1/mm	Article no.	Page
---	---	---	---	---	---	-------------------	---	----------	------------	--------	---------------	---------------	---------	-------	-------------	------

Chamfering milling cutters

•	•	•	•	•	○		4	55 HRC	HA			VHM	A	4.000 - 12.000	6711	226
•	•	•	•	•	○		4	55 HRC	HB			VHM	A	4.000 - 12.000	6712	226
•	•	•	•	•	○		4	55 HRC	HA			VHM	A	4.000 - 12.000	6713	227
•	•	•	•	•	○		4	55 HRC	HB			VHM	A	4.000 - 12.000	3396	227
•	•	•	•	•	•		4	63 HRC	HA			VHM	Y	4.000 - 12.000	6784	228
•	•	•	•	•	•		4	63 HRC	HB			VHM	Y	4.000 - 12.000	6785	228
•	•	•	•	•	○		4	55 HRC	HA			VHM	A	4.000 - 12.000	6714	229
•	•	•	•	•	○		4	55 HRC	HB			VHM	A	4.000 - 12.000	6715	229
•	•	•	•	•	○		6	55 HRC	HA			VHM	A	6.000 - 20.000	6786	230
•	•	•	•	•	○		6	55 HRC	HB			VHM	A	6.000 - 20.000	6787	230

Front/back deburrer 90°

•	•	•	○	•	•		4	55 HRC	HA			VHM	a	3.000 - 12.000	495	231
---	---	---	---	---	---	--	---	--------	----	--	--	-----	---	----------------	-----	-----

Quadrant milling cutters

•	•	•	•	○	•		4	55 HRC	HA			VHM	F	6.000 - 20.000	6788	232
---	---	---	---	---	---	--	---	--------	----	--	--	-----	---	----------------	------	-----

Slot drills (2-fluted)

•	•	•	•	•	•		2		HA			VHM	○	2.000 - 20.000	3194	233
•	•	•	•	•	•		2		HA			VHM	F	2.000 - 20.000	3633	233
•	•	•	•	•	•		2		HB			VHM	○	2.000 - 20.000	3294	234
•	•	•	•	•	•		2		HB			VHM	F	2.000 - 20.000	3634	234
•	•	•	•	•	•		2		HA			VHM	○	1.000 - 20.000	3195	235
•	•	•	•	•	•		2		HA			VHM	F	1.000 - 20.000	3635	235
•	•	•	•	•	•		2		HB			VHM	○	2.000 - 20.000	3295	236
•	•	•	•	•	•		2		HB			VHM	F	2.000 - 20.000	3154	236
•	•	•	•	•	•		2		-HA			VHM	○	2.000 - 20.000	3212	237
•	•	•	•	•	•		2		-HA			VHM	F	2.000 - 20.000	3709	237

Solid carbide universal milling cutters

P	M	K	N	S	H	Tool illustration	Z	Hardness	Shank form	Length	Helix angle °	Tool material	Surface	d1/mm	Article no.	Page
Slot drills (2-fluted)																
•	•	•	•					-HA			30°	VHM	○	2.000 - 20.000	3303	238
•	•	•	•					-HA			30°	VHM	Ⓡ	2.000 - 20.000	3676	238
XL slot drills (2-fluted)																
•	•	•	•					HA			30°	VHM	○	3.000 - 20.000	3011	239
•	•	•	•					HA			30°	VHM	Ⓡ	3.000 - 20.000	3021	239
Al slot drills (2-fluted)																
		•						HA			45°	VHM	○	3.000 - 20.000	3310	240
		•						HB			45°	VHM	○	3.000 - 20.000	3126	240
		•						HA			45°	VHM	○	3.000 - 20.000	3309	241
		•						HB			45°	VHM	○	3.000 - 20.000	3059	241
XL Al slot drills (2-fluted)																
		•						HA			45°	VHM	○	5.000 - 16.000	3358	242
Slot drills (3-fluted)																
•	•	•	•					HA			30°	VHM	○	2.000 - 20.000	3555	243
•	•	•	•					HA			30°	VHM	Ⓡ	2.000 - 20.000	3558	243
•	•	•	•					HB			30°	VHM	○	2.000 - 20.000	3296	244
•	•	•	•					HB			30°	VHM	Ⓡ	2.000 - 20.000	3719	244
•	•	•	•					HA			30°	VHM	○	2.000 - 20.000	3559	245
•	•	•	•					HA			30°	VHM	Ⓡ	2.000 - 20.000	3560	245
•	•	•	•					HB			30°	VHM	○	2.000 - 20.000	3297	246
•	•	•	•					HB			30°	VHM	Ⓡ	2.000 - 20.000	3720	246
•	•	•	•					-HA			30°	VHM	○	2.000 - 20.000	3307	247
•	•	•	•					-HA			30°	VHM	Ⓡ	2.000 - 20.000	3677	247
•	•	•	•					-HA			30°	VHM	○	2.000 - 20.000	3220	248
•	•	•	•					-HA			30°	VHM	Ⓡ	2.000 - 20.000	3711	248

Solid carbide universal milling cutters



P	M	K	N	S	H	Tool illustration	Z	Hardness	Shank form	Length	Helix angle °	Tool material	Surface	d1/mm	Article no.	Page
Slot drills XL (3-fluted)																
•	•	•	•				3	HA	HA	30°	VHM	○	3.000 - 20.000	3314	249	
•	•	•	•				3	HA	HA	30°	VHM	Ⓡ	3.000 - 20.000	3680	249	
Mini slot drills (3-fluted)																
•	•	○	•	•			3	HA/HB	HA/HB	30°	VHM	Ⓡ	0.300 - 20.000	3684	250	
•	•	○	•	○			3	HA/HB	HA/HB	45°	VHM	Ⓡ	1.000 - 10.000	3686	251	
End mills (4-fluted)																
•	•	•	•				4	HA	HA	30°	VHM	○	2.000 - 20.000	3198	252	
•	•	•	•				4	HA	HA	30°	VHM	Ⓡ	2.000 - 20.000	3637	252	
•	•	•	•				4	HB	HA	30°	VHM	○	2.000 - 20.000	3298	253	
•	•	•	•				4	HB	HA	30°	VHM	Ⓡ	2.000 - 20.000	3721	253	
•	•	•	•				4	HA	HA	30°	VHM	○	2.000 - 20.000	3197	254	
•	•	•	•				4	HA	HA	30°	VHM	Ⓡ	2.000 - 20.000	3649	254	
•	•	•	•				4	HB	HA	30°	VHM	○	2.000 - 20.000	3299	255	
•	•	•	•				4	HB	HA	30°	VHM	Ⓡ	2.000 - 20.000	3722	255	
•	•	•	•				4	-HA	HA	30°	VHM	○	2.000 - 20.000	3304	256	
•	•	•	•				4	-HA	HA	30°	VHM	Ⓡ	2.000 - 20.000	3678	256	
•	•	•	•				4	-HA	HA	30°	VHM	○	4.500 - 20.000	3257	257	
•	•	•	•				4	-HA	HA	30°	VHM	Ⓡ	4.500 - 20.000	3713	257	
XL slot drills (2-fluted)																
•	•	•	•				4	HA	HA	30°	VHM	○	3.000 - 20.000	3012	258	
•	•	•	•				4	HA	HA	30°	VHM	Ⓡ	3.000 - 20.000	3023	258	
Ratio end mill sets RF 100 Diver																
•	•	•	•	•			4	48 HRC	HA	36° 38° 37°	VHM	Ⓡ		6755	259	

Solid carbide universal milling cutters

P	M	K	N	S	H	Tool illustration	Z	Hardness	Shank form	Length	Helix angle °	Tool material	Surface	d1/mm	Article no.	Page
---	---	---	---	---	---	-------------------	---	----------	------------	--------	---------------	---------------	---------	-------	-------------	------

Ratio end mill sets RF 100 Diver

•	•	•	•	•			4	48 HRC	HB		36° 38° 37°	VHM	Y		6754	260
---	---	---	---	---	--	--	---	--------	----	--	-------------------	-----	---	--	------	-----

Ratio end mill sets RF 100 Speed

•	•						4		HA		48°	VHM	A		6778	261
•	•						4		HB		48°	VHM	A		6780	262
•	•						4		HA		48°	VHM	A		6777	263
•	•						4		HB		48°	VHM	A		6781	264

Ratio end mill sets RF 100 U Z3

•	•	•	•	•	○		3		HB		41° 43° 45°	VHM	F		4372	265
---	---	---	---	---	---	--	---	--	----	--	-------------------	-----	---	--	------	-----

Ratio end mill sets RF 100 U

•	○	•	○	○			4	48 HRC	HB		35° 38°	VHM	F		5634	266
•	○	•	○	○			4		HA		35° 38°	VHM	F		5645	267

Solid carbide universal milling cutters



P	M	K	N	S	H	Tool illustration	Z	Hardness	Shank form	Length	Helix angle °	Tool material	Surface	d1/mm	Article no.	Page
---	---	---	---	---	---	-------------------	---	----------	------------	--------	---------------	---------------	---------	-------	-------------	------

Ratio end mill sets RF 100 U

•	○	•	○	○				48 HRC				VHM			5635	268
---	---	---	---	---	--	--	--	--------	--	--	--	-----	--	--	------	-----

Ratio end mill sets RF 100 VA

•	•	○	•									VHM			4370	269
---	---	---	---	--	--	--	--	--	--	--	--	-----	--	--	------	-----

Ratio end mill sets RF 100 VA NF

•	•	•	○	○								VHM			4371	270
---	---	---	---	---	--	--	--	--	--	--	--	-----	--	--	------	-----

High-performance roughing end mills RS 100 U, set

•	•	○	•	○								VHM			4352	271
---	---	---	---	---	--	--	--	--	--	--	--	-----	--	--	------	-----

•	•	○	•									VHM			4345	272
---	---	---	---	--	--	--	--	--	--	--	--	-----	--	--	------	-----

•	•	○	•									VHM			4344	273
---	---	---	---	--	--	--	--	--	--	--	--	-----	--	--	------	-----

High-performance roughing end mills RS 100 F, set

•	•	○						48 HRC				VHM			4353	274
---	---	---	--	--	--	--	--	--------	--	--	--	-----	--	--	------	-----

Solid carbide universal milling cutters



P	M	K	N	S	H	Tool illustration	Z	Hardness	Shank form	Length	Helix angle °	Tool material	Surface	d1/mm	Article no.	Page
---	---	---	---	---	---	-------------------	---	----------	------------	--------	---------------	---------------	---------	-------	-------------	------

High-performance roughing end mills RS 100 F, set

•	•				○		5-6	48 HRC	HA		45°	VHM	F		4348	275
•	•				○		5-6	48 HRC	HB		45°	VHM	F		4347	276

Slot drills (2-fluted), set

•	•	•	•				2		HB		30°	VHM	F		3798	277
---	---	---	---	--	--	--	---	--	----	--	-----	-----	---	--	------	-----

Slot drills GH 100 U (3-fluted), set

•	•	•	○	○			3		HB		45°	VHM	F		5636	278
---	---	---	---	---	--	--	---	--	----	--	-----	-----	---	--	------	-----

End mills (4-fluted), set

•	•	•	•				4		HB		30°	VHM	F		3799	279
---	---	---	---	--	--	--	---	--	----	--	-----	-----	---	--	------	-----

Solid carbide universal milling cutters



P	M	K	N	S	H	Tool illustration	Z	Hardness	Shank form	Length	Helix angle °	Tool material	Surface	d1/mm	Article no.	Page
---	---	---	---	---	---	-------------------	---	----------	------------	--------	---------------	---------------	---------	-------	-------------	------

Ratio end mills RF 40

•	•	•	•	•	○			B				HSS-E-PM	○	8.000 - 30.000	3429	287
•	•	•	•	•	○			B				HSS-E-PM	Ⓡ	8.000 - 30.000	3705	287
•	•	•	•	•	○			B				HSS-E-PM	○	16.000 - 30.000	3432	288
•	•	•	•	•	○			B				HSS-E-PM	Ⓡ	16.000 - 30.000	3706	288

Roughing end mills GS 40 with fine teeth

•	•	•	•	•	○			B				HSS-E-PM	○	6.000 - 20.000	3322	289
•	•	•	•	•	○			B				HSS-E-PM	Ⓡ	6.000 - 20.000	3668	289
•	•	•	•	•	○			B				HSS-E-PM	○	6.000 - 32.000	3340	290
•	•	•	•	•	○			B				HSS-E-PM	Ⓡ	6.000 - 32.000	3660	290

Roughing end mills GS 80 with fine teeth

•	•	•	•	•	○			B				HSS-E-PM	Ⓡ	4.000 - 25.000	6756	292
---	---	---	---	---	---	--	--	---	--	--	--	----------	---	----------------	-------------	-----



P	M	K	N	S	H	Tool illustration	Z	Hardness	Shank form	Length	Helix angle °	Tool material	Surface	d1/mm	Article no.	Page
Slot drills (2-fluted)																
•	○	•	•	•					B			HSCO	○	1.000 - 25.000	3451	293
•	○	•	•	•					B			HSCO	Ⓡ	1.000 - 25.000	3663	293
•	○	•	•	•					B			HSCO	○	3.000 - 20.000	3452	294
•	○	•	•	•					B			HSCO	Ⓡ	3.000 - 20.000	3694	294
•	○	•	•	•					B			HSCO	○	3.000 - 20.000	3453	295
•	○	•	•	•					B			HSCO	Ⓡ	3.000 - 20.000	3695	295
Ball nose slot drills (2-fluted)																
•	○	•	•	•					B			HSCO	○	2.000 - 30.000	3466	296
•	•	•	•	•					B			HSCO	Ⓡ	2.000 - 30.000	3703	296
•	○	•	•	•					B			HSCO	○	3.000 - 30.000	3467	297
•	•	•	•	•					B			HSCO	Ⓡ	3.000 - 30.000	3704	297
Mini slot drills (3-fluted)																
•	•	•	•	•					B			HSCO	○	3.000 - 10.000	3142	298
•	•	•	•	•					B			HSCO	Ⓡ	3.000 - 10.000	3144	298
•	•	•	•	•					B			HSCO	○	3.000 - 10.000	3143	299
•	•	•	•	•					B			HSCO	Ⓡ	3.000 - 10.000	3145	299
Slot drills (3-fluted)																
•	○	•	•	•					B			M42	○	2.800 - 30.000	3458	300
•	○	•	•	•					B			HSCO	Ⓡ	2.800 - 30.000	3651	300
•	○	•	•	•					B			M42	○	2.800 - 20.000	3459	301
•	○	•	•	•					B			HSCO	Ⓡ	2.800 - 20.000	3664	301
•	○	•	•	•					B			HSCO	○	3.000 - 20.000	3460	302
•	○	•	•	•					B			HSCO	Ⓡ	3.000 - 20.000	3836	302
End mills																
•	○	•	•	•					B			HSCO	○	2.000 - 32.000	3428	303



P	M	K	N	S	H	Tool illustration	Z	Hardness	Shank form	Length	Helix angle °	Tool material	Sur-face	d1/mm	Article no.	Page
---	---	---	---	---	---	-------------------	---	----------	------------	--------	---------------	---------------	----------	-------	-------------	------

End mills

•	○	•	•						B			HSCO	F	2.000 - 32.000	3670	303
•	○	•	•						B			HSCO	○	3.000 - 40.000	3431	304
•	○	•	•						B			HSCO	F	3.000 - 40.000	3692	304
•	○	•	•						B			HSCO	○	6.000 - 20.000	3433	305

Roughing end mills

•	○	•	•						B			M42	○	6.000 - 40.000	3346	306
•	○	•	•						B			HSCO	F	6.000 - 40.000	3690	306
•	○	•	•						B			HSCO	○	6.000 - 36.000	3347	307
•	○	•	•						B			HSCO	F	6.000 - 36.000	3650	307

Roughing/finishing end mills

•	○	•	•						B			M42	○	6.000 - 40.000	3343	308
•	○	•	•						B			HSCO	F	6.000 - 40.000	3669	308
•	○	•	•						B			HSCO	○	6.000 - 36.000	3342	309
•	○	•	•						B			HSCO	F	6.000 - 36.000	3698	309

Morse taper end mills

•	○	•	•						MK			HSCO	○	10.000 - 50.000	3117	310
•	○	•	•						MK			HSCO	○	14.000 - 45.000	3440	311
•	○	•	•						MK			HSCO	○	16.000 - 50.000	3121	312
•	○	•	•						MK			HSCO	○	16.000 - 63.000	3120	313

Side and face cutters

•	○	•	•									HSCO	○	50.000 - 160.000	3530	314
---	---	---	---	--	--	--	--	--	--	--	--	------	---	------------------	------	-----

Shell end mills

•	○	•	•									M42	○	40.000 - 125.000	3504	315
•	○	•	•									HSCO	C	40.000 - 125.000	3654	315
•	○	•	•									M42	○	40.000 - 125.000	3185	316

Universal milling cutters M42

P	M	K	N	S	H	Tool illustration	Z	Hardness	Shank form	Length	Helix angle °	Tool material	Surface	d1/mm	Article no.	Page
Shell end mills																
•	○	•	•									HSCO	⊙	40.000 - 125.000	3749	316
•	○	•	•									M42	○	40.000 - 125.000	3187	317
T-slot end mills																
•	○	•	•						B			HSCO	○	12.500 - 32.000	3570	318
Woodruff cutters																
•	○	•	•						B			HSCO	○	4.500 - 45.500	3580	319
Dovetail cutters																
•	○	•	•						B			HSCO	○	16.000 - 32.000	3572	320
•	○	•	•						B			HSCO	○	16.000 - 32.000	3576	320
•	○	•	•						B			HSCO	○	16.000 - 32.000	3574	321
•	○	•	•						B			HSCO	○	16.000 - 32.000	3577	321
Quadrant milling cutters																
•	○	•	•						B			HSCO	○	10.000 - 58.000	3176	322



Article no.	Page	Standard	Description	Tool material	Type	Form
495	231	Company std.	Front/back deburrer 90°	Solid carbide	EW 100 VR	
1612	216	Company std.	Toxx screwdriver			
1691	216	Company std.	Clamping screws for diesinking cutter holders			
1941	213	Company std.	Die sinking cutter holder GF 200 WP		GF 200	
1942	214	Company std.	Die sinking cutter holder GF 200 WP		GF 200	
1947	215	Company std.	Indexable inserts round	Cermet	GF 200	
2520	215	Company std.	Indexable inserts round	Solid carbide	GF 200	
3011	239	Company std.	XL slot drills (2-fluted)	Solid carbide	N	
3012	258	Company std.	XL slot drills (2-fluted)	Solid carbide	N	
3014	197	Company std.	XL ball nose slot drills (2-fluted)	Solid carbide	N	
3015	198	Company std.	XL ball nose end mills (4-fluted)	Solid carbide	N	
3016	162	Company std.	HSC face milling cutters	PCD	PF 1000 G	KZ
3021	239	Company std.	XL slot drills (2-fluted)	Solid carbide	N	
3023	258	Company std.	XL end mills (4-fluted)	Solid carbide	N	
3024	193	DIN 6527L	Ball nose slot drills (2-fluted)	Solid carbide	N	B
3026	196	DIN 6527L	Ball nose end mills (4-fluted)	Solid carbide	N	B
3030	197	Company std.	XL ball nose slot drills (2-fluted)	Solid carbide	N	
3043	198	Company std.	XL ball nose end mills (4-fluted)	Solid carbide	N	
3044	208	Company std.	Ball nose end mills GF 200 B	Solid carbide	H	
3045	207	Company std.	Ball nose end mills GF 200 B	Solid carbide	N	
3047	57	Company std.	Multi-tooth end mills GH 100 U	Solid carbide	NH	
3049	192	DIN 6527L	Ball nose slot drills (2-fluted)	Solid carbide	N	B
3050	196	DIN 6527L	Ball nose end mills (4-fluted)	Solid carbide	N	B
3059	130, 241	DIN 6527L	Al slot drills (2-fluted)	Solid carbide	W	B
3106	176	DIN 6527L	Slot drills with corner radius (2-fluted)	Solid carbide	N	A
3111	177	DIN 6527L	End mills with corner radius (4-fluted)	Solid carbide	N	A
3117	310	DIN 845K	Morse taper end mills	HSCO	NR	B
3120	313	DIN 845L	Morse taper end mills	HSCO	N	B
3121	312	DIN 845L	Morse taper end mills	HSCO	NR	B
3126	129, 240	DIN 6527K	Al slot drills (2-fluted)	Solid carbide	W	B
3127	132	DIN 6527L	Roughing end mills GS 100 A (coarse teeth)	Solid carbide	WR	B
3142	298	Company std.	Mini slot drills (3-fluted)	HSCO	N	
3143	299	Company std.	Mini slot drills (3-fluted)	HSCO	N	
3144	298	Company std.	Mini slot drills (3-fluted)	HSCO	N	
3145	299	Company std.	Mini slot drills (3-fluted)	HSCO	N	
3154	236	DIN 6527L	Slot drills (2-fluted)	Solid carbide	N	B
3176	322	DIN 6518	Quadrant milling cutters	HSCO	N	B/D
3185	316	DIN 1880	Shell end mills	M42	NR	
3187	317	DIN 1880	Shell end mills	M42	NF	
3193	18	DIN 6527K	Slot drills GH 100 U (3-fluted)	Solid carbide	NH	A
3194	233	DIN 6527K	Slot drills (2-fluted)	Solid carbide	N	A
3195	235	DIN 6527L	Slot drills (2-fluted)	Solid carbide	N	A
3196	20	DIN 6527L	Slot drills GH 100 U (3-fluted)	Solid carbide	NH	A
3197	254	DIN 6527L	End mills (4-fluted)	Solid carbide	N	A
3198	252	DIN 6527K	End mills (4-fluted)	Solid carbide	N	A
3200	34	DIN 6527K	Standard Ratio end mills RF 100 U	Solid carbide	N	B
3201	36	DIN 6527L	Standard Ratio end mills RF 100 U	Solid carbide	N	B
3202	123	DIN 6527L	Ratio end mills Alu RF 100 A	Solid carbide	W	A
3203	17	DIN 6528	Slot drills GH 100 U (3-fluted)	Solid carbide	NH	
3204	49, 104	DIN 6527L	Roughing end mills GS 100 U (fine teeth)	Solid carbide	NRf	B
3208	36	DIN 6527L	Standard Ratio end mills RF 100 U	Solid carbide	N	A
3209	40	Company std.	Standard Ratio end mills RF 100 U	Solid carbide	N	
3212	237	Company std.	Slot drills (2-fluted)	Solid carbide	N	
3220	248	Company std.	Slot drills (3-fluted)	Solid carbide	N	
3257	257	Company std.	End mills (4-fluted)	Solid carbide	N	
3294	234	DIN 6527K	Slot drills (2-fluted)	Solid carbide	N	B
3295	236	DIN 6527L	Slot drills (2-fluted)	Solid carbide	N	B
3296	244	DIN 6527K	Slot drills (3-fluted)	Solid carbide	N	B
3297	246	DIN 6527L	Slot drills (3-fluted)	Solid carbide	N	B
3298	253	DIN 6527K	End mills (4-fluted)	Solid carbide	N	B
3299	255	DIN 6527L	End mills (4-fluted)	Solid carbide	N	B
3303	238	DIN 6528	Slot drills (2-fluted)	Solid carbide	N	
3304	256	DIN 6528	End mills (4-fluted)	Solid carbide	N	
3306	195	DIN 6528	Ball nose end mills (4-fluted)	Solid carbide	N	
3307	247	DIN 6528	Slot drills (3-fluted)	Solid carbide	N	
3308	194	DIN 6527L	Ball nose slot drills (2-fluted)	Solid carbide	N	A
3309	130, 241	DIN 6527L	Al slot drills (2-fluted)	Solid carbide	W	A
3310	129, 240	DIN 6527K	Al slot drills (2-fluted)	Solid carbide	W	A
3311	56	Company std.	Multi-tooth end mills GH 100 U	Solid carbide	NH	
3312	58	Company std.	Multi-tooth end mills GH 100 U	Solid carbide	NH	
3313	59	Company std.	Multi-tooth end mills GH 100 U	Solid carbide	NH	
3314	249	Company std.	Slot drills XL (3-fluted)	Solid carbide	N	

Article no.	Page	Standard	Description	Tool material	Type	Form
3319	123	DIN 6527L	Ratio end mills Alu RF 100 A	Solid carbide	W	B
3322	289	DIN 844K	Roughing end mills GS 40 with fine teeth	HSS-E-PM	NRf	B
3340	290	DIN 844K	Roughing end mills GS 40 with fine teeth	HSS-E-PM	NRf	B
3342	309	DIN 844L	Roughing/finishing end mills	HSCO	NF	B
3343	308	DIN 844K	Roughing/finishing end mills	M42	NF	B
3346	306	DIN 844K	Roughing end mills	M42	NR	B
3347	307	DIN 844L	Roughing end mills	HSCO	NR	B
3358	131, 242	Company std.	XL Al slot drills (2-fluted)	Solid carbide	W	
3359	209	Company std.	Ball nose hard profile cutters GF 300 B	Solid carbide	H	
3360	210	Company std.	Ball nose hard profile cutters GF 300 B	Solid carbide	H	
3361	62, 188	Company std.	Hard profile cutters with Torus grind GF 300 T	Solid carbide	H	A
3362	63, 189	Company std.	Hard profile cutters with Torus grind GF 300 T	Solid carbide	H	A
3363	191	Company std.	Hard multi-tooth end mills corner radius GH 100 H	Solid carbide	H	
3364	132	DIN 6527L	Roughing end mills GS 100 A (coarse teeth)	Solid carbide	WR	B
3365	50, 105	DIN 6527L	Roughing end mills GS 100 U (fine teeth)	Solid carbide	NRf	B
3366	28, 94	DIN 6527L	Ratio end mills RF 100 F	Solid carbide	NH	B
3367	127	Company std.	Slot drills GA 200 A (3-fluted)	Solid carbide	W	
3396	227	Company std.	Chamfering milling cutters	Solid carbide	N	
3428	303	DIN 844K	End mills	HSCO	N	B
3429	287	DIN 844K	Ratio end mills RF 40	HSS-E-PM	N	B
3431	304	DIN 844L	End mills	HSCO	N	B
3432	288	DIN 844L	Ratio end mills RF 40	HSS-E-PM	N	B
3433	305	Company std.	End mills	HSCO	N	
3440	311	DIN 845K	Morse taper end mills	HSCO	N	B
3451	293	DIN 327	Slot drills (2-fluted)	HSCO	N	D
3452	294	DIN 844K	Slot drills (2-fluted)	HSCO	N	B
3453	295	DIN 844L	Slot drills (2-fluted)	HSCO	N	B
3458	300	DIN 327	Slot drills (3-fluted)	M42	N	D
3459	301	DIN 844K	Slot drills (3-fluted)	M42	N	B
3460	302	DIN 844L	Slot drills (3-fluted)	HSCO	N	B
3466	296	DIN 327	Ball nose slot drills (2-fluted)	HSCO	N	D
3467	297	Company std.	Ball nose slot drills (2-fluted)	HSCO	N	
3472	117	Company std.	Ratio end mills Alu RF 100 A	Solid carbide	W	
3473	119	Company std.	Ratio end mills Alu RF 100 A	Solid carbide	W	
3498	100	DIN 6527L	Ratio end mills RF 100 Ti	Solid carbide	N	A
3499	100	DIN 6527L	Ratio end mills RF 100 Ti	Solid carbide	N	B
3504	315	DIN 1880	Shell end mills	M42	N	
3530	314	DIN 885	Side and face cutters	HSCO	N	A
3540	18	DIN 6527K	Slot drills GH 100 U (3-fluted)	Solid carbide	NH	A
3555	243	DIN 6527K	Slot drills (3-fluted)	Solid carbide	N	A
3558	243	DIN 6527K	Slot drills (3-fluted)	Solid carbide	N	A
3559	245	DIN 6527L	Slot drills (3-fluted)	Solid carbide	N	A
3560	245	DIN 6527L	Slot drills (3-fluted)	Solid carbide	N	A
3561	176	DIN 6527L	Slot drills with corner radius (2-fluted)	Solid carbide	N	A
3562	177	DIN 6527L	End mills with corner radius (4-fluted)	Solid carbide	N	A
3563	178	DIN 6527L	Multi-tooth end mills with corner radius GH 100 U	Solid carbide	NH	A
3570	318	DIN 851	T-slot end mills	HSCO	N	A/B
3572	320	DIN 1833	Dovetail cutters	HSCO	H	C
3574	321	DIN 1833	Dovetail cutters	HSCO	H	C
3576	320	DIN 1833	Dovetail cutters	HSCO	H	D
3577	321	DIN 1833	Dovetail cutters	HSCO	H	D
3580	319	DIN 850	Woodruff cutters	HSCO	N	D
3599	118	Company std.	Ratio end mills Alu RF 100 A	Solid carbide	W	A
3627	40	Company std.	Standard Ratio end mills RF 100 U	Solid carbide	N	
3629	27, 93	DIN 6527L	Ratio end mills RF 100 F	Solid carbide	NH	A
3630	27, 93	DIN 6527L	Ratio end mills RF 100 F	Solid carbide	NH	B
3631	53, 109, 134	Company std.	Ratio end mills Superfinish RF 100 SF	Solid carbide	NH	
3632	53, 109, 134	Company std.	Ratio end mills Superfinish RF 100 SF	Solid carbide	NH	
3633	233	DIN 6527K	Slot drills (2-fluted)	Solid carbide	N	A
3634	234	DIN 6527K	Slot drills (2-fluted)	Solid carbide	N	B
3635	235	DIN 6527L	Slot drills (2-fluted)	Solid carbide	N	A
3636	20	DIN 6527L	Slot drills GH 100 U (3-fluted)	Solid carbide	NH	A
3637	252	DIN 6527K	End mills (4-fluted)	Solid carbide	N	A
3649	254	DIN 6527L	End mills (4-fluted)	Solid carbide	N	A
3650	307	DIN 844L	Roughing end mills	HSCO	NR	B
3651	300	DIN 327	Slot drills (3-fluted)	HSCO	N	D
3654	315	DIN 1880	Shell end mills	HSCO	N	
3660	290	DIN 844K	Roughing end mills GS 40 with fine teeth	HSS-E-PM	NRf	B
3663	293	DIN 327	Slot drills (2-fluted)	HSCO	N	D
3664	301	DIN 844K	Slot drills (3-fluted)	HSCO	N	B
3668	289	DIN 844K	Roughing end mills GS 40 with fine teeth	HSS-E-PM	NRf	B
3669	308	DIN 844K	Roughing/finishing end mills	HSCO	NF	B



Article no.	Page	Standard	Description	Tool material	Type	Form
3670	303	DIN 844K	End mills	HSCO	N	B
3676	238	DIN 6528	Slot drills (2-fluted)	Solid carbide	N	
3677	247	DIN 6528	Slot drills (3-fluted)	Solid carbide	N	
3678	256	DIN 6528	End mills (4-fluted)	Solid carbide	N	
3679	192	DIN 6527L	Ball nose slot drills (2-fluted)	Solid carbide	N	A
3680	249	Company std.	Slot drills XL (3-fluted)	Solid carbide	N	
3682	65	DIN 6527L	Hard roughing end mills GS 100 H (fine teeth)	Solid carbide	HR	B
3684	250	Company std.	Mini slot drills (3-fluted)	Solid carbide	N	
3686	251	Company std.	Mini slot drills (3-fluted)	Solid carbide	NH	
3689	56	Company std.	Multi-tooth end mills GH 100 U	Solid carbide	NH	
3690	306	DIN 844K	Roughing end mills	HSCO	NR	B
3691	58	Company std.	Multi-tooth end mills GH 100 U	Solid carbide	NH	
3692	304	DIN 844L	End mills	HSCO	N	B
3693	59	Company std.	Multi-tooth end mills GH 100 U	Solid carbide	NH	
3694	294	DIN 844K	Slot drills (2-fluted)	HSCO	N	B
3695	295	DIN 844L	Slot drills (2-fluted)	HSCO	N	B
3698	309	DIN 844L	Roughing/finishing end mills	HSCO	NF	B
3703	296	DIN 327	Ball nose slot drills (2-fluted)	HSCO	N	D
3704	297	Company std.	Ball nose slot drills (2-fluted)	HSCO	N	
3705	287	DIN 844K	Ratio end mills RF 40	HSS-E-PM	N	B
3706	288	DIN 844L	Ratio end mills RF 40	HSS-E-PM	N	B
3709	237	Company std.	Slot drills (2-fluted)	Solid carbide	N	
3711	248	Company std.	Slot drills (3-fluted)	Solid carbide	N	
3713	257	Company std.	End mills (4-fluted)	Solid carbide	N	
3715	67	Company std.	Hard multi-tooth end mills GH 100 H	Solid carbide	H	
3716	68	Company std.	Hard multi-tooth end mills GH 100 H	Solid carbide	H	
3719	244	DIN 6527K	Slot drills (3-fluted)	Solid carbide	N	B
3720	246	DIN 6527L	Slot drills (3-fluted)	Solid carbide	N	B
3721	253	DIN 6527K	End mills (4-fluted)	Solid carbide	N	B
3722	255	DIN 6527L	End mills (4-fluted)	Solid carbide	N	B
3723	49, 104	DIN 6527L	Roughing end mills GS 100 U (fine teeth)	Solid carbide	NRf	B
3727	195	DIN 6528	Ball nose end mills (4-fluted)	Solid carbide	N	
3729	19	DIN 6527K	Slot drills GH 100 U (3-fluted)	Solid carbide	NH	B
3730	21	DIN 6527L	Slot drills GH 100 U (3-fluted)	Solid carbide	NH	B
3731	33	DIN 6527K	Standard Ratio end mills RF 100 U	Solid carbide	N	B
3732	35	DIN 6527L	Standard Ratio end mills RF 100 U	Solid carbide	N	B
3736	35	DIN 6527L	Standard Ratio end mills RF 100 U	Solid carbide	N	A
3741	17	DIN 6528	Slot drills GH 100 U (3-fluted)	Solid carbide	NH	
3749	316	DIN 1880	Shell end mills	HSCO	NR	
3798	277	DIN 6527L	Slot drills (2-fluted), set	Solid carbide	N	
3799	279	DIN 6527L	End mills (4-fluted), set	Solid carbide	N	
3800	80	DIN 6527L	Ratio end mills RF 100 VA	Solid carbide	N	A
3803	80	DIN 6527L	Ratio end mills RF 100 VA	Solid carbide	N	B
3804	79	DIN 6527K	Ratio end mills RF 100 VA	Solid carbide	N	A
3805	79	DIN 6527K	Ratio end mills RF 100 VA	Solid carbide	N	B
3806	82	Company std.	Ratio end mills RF 100 VA	Solid carbide	N	
3807	82	Company std.	Ratio end mills RF 100 VA	Solid carbide	N	
3836	302	DIN 844L	Slot drills (3-fluted)	HSCO	N	B
3837	38	Company std.	Standard Ratio end mills RF 100 U	Solid carbide	N	
3838	38	Company std.	Standard Ratio end mills RF 100 U	Solid carbide	N	
3839	39	Company std.	Standard Ratio end mills RF 100 U	Solid carbide	N	
3848	201	Company std.	HSC-ball nose end mills GF 500 B	Solid carbide	N	
3849	203	Company std.	HSC-ball nose end mills GF 500 B	Solid carbide	N	
3853	204	Company std.	HSC-ball nose end mills GF 500 B	Solid carbide	N	
3854	199	Company std.	HSC-ball nose end mills GF 500 B	Solid carbide	N	
3855	202	Company std.	HSC-ball nose end mills GF 500 B	Solid carbide	N	
3856	180	Company std.	HSC Torus end mills GF 500 T	Solid carbide	NH	A
3859	182	Company std.	HSC Torus end mills GF 500 T	Solid carbide	N	
3860	183	Company std.	HSC Torus end mills GF 500 T	Solid carbide	N	
3863	179	Company std.	HSC Torus end mills GF 500 T	Solid carbide	N	
3865	181	Company std.	HSC Torus end mills GF 500 T	Solid carbide	N	
3866	200	Company std.	HSC-ball nose end mills GF 500 B	Solid carbide	N	
3871	39	Company std.	Standard Ratio end mills RF 100 U	Solid carbide	N	
3872	42	DIN 6527L	Standard Ratio end mills RF 100 U	Solid carbide	N	A
3873	42	DIN 6527L	Standard Ratio end mills RF 100 U	Solid carbide	N	B
3891	16, 75	Company std.	Standard Ratio end mills RF 100 U (3-fluted)	Solid carbide	N	
3892	16, 75	Company std.	Standard Ratio end mills RF 100 U (3-fluted)	Solid carbide	N	
3893	15, 74	Company std.	Standard Ratio end mills RF 100 U (3-fluted)	Solid carbide	N	
3894	15, 74	Company std.	Standard Ratio end mills RF 100 U (3-fluted)	Solid carbide	N	
3895	61	DIN 6527L	Ratio end mills RF 100 H	Solid carbide	H	A
3896	61	DIN 6527L	Ratio end mills RF 100 H	Solid carbide	H	B
3897	54, 110, 135	Company std.	Ratio end mills Superfinish RF 100 SF	Solid carbide	NH	

Article no.	Page	Standard	Description	Tool material	Type	Form
3898	54, 110, 135	Company std.	Ratio end mills Superfinish RF 100 SF	Solid carbide	NH	
4201	164	Company std.	HSC face milling cutters		PF 3000	
4203	166	Company std.	Coolant distributor		PF 3000	
4204	165	Company std.	PCD cartridges HSC	PCD	PF 3000	
4246	211	Company std.	Ball nose hard profile cutters GF 300 B	Solid carbide	H	A
4247	212	Company std.	Ball nose hard profile cutters GF 300 B	Solid carbide	H	
4248	205	Company std.	HSC-ball nose end mills GF 500 B	Solid carbide	N	A
4249	206	Company std.	HSC-ball nose end mills GF 500 B	Solid carbide	N	
4268	184	Company std.	HSC Torus end mills GF 500 T	Solid carbide	N	A
4269	185	Company std.	HSC Torus end mills GF 500 T	Solid carbide	N	
4270	66, 190	Company std.	Hard multi-tooth end mills corner radius GH 100 H	Solid carbide	H	A
4344	273	DIN 6527L	High-performance roughing end mills RS 100 U, set	Solid carbide	NF	
4345	272	DIN 6527L	High-performance roughing end mills RS 100 U, set	Solid carbide	NF	
4347	276	DIN 6527L	High-performance roughing end mills RS 100 F, set	Solid carbide	NF	
4348	275	DIN 6527L	High-performance roughing end mills RS 100 F, set	Solid carbide	NF	
4352	271	DIN 6527L	High-performance roughing end mills RS 100 U, set	Solid carbide	NF	
4353	274	DIN 6527L	High-performance roughing end mills RS 100 F, set	Solid carbide	NF	
4370	269	DIN 6527L	Ratio end mill sets RF 100 VA	Solid carbide	N	B
4371	270	DIN 6527L	Ratio end mill sets RF 100 VA NF	Solid carbide	NF	B
4372	265	Company std.	Ratio end mill sets RF 100 U Z3	Solid carbide	NH	
5492	157	Company std.	PCD slot drills (2-fluted)	PCD		AX
5493	158	Company std.	PCD slot drills (2-fluted)	PCD		AX
5495	159	Company std.	PCD slot drills (3-fluted)	PCD		AX
5496	160	Company std.	PCD slot drills (3-fluted)	PCD		AX
5634	266	DIN 6527K	Ratio end mill sets RF 100 U	Solid carbide	N	B
5635	268	DIN 6527L	Ratio end mill sets RF 100 U	Solid carbide	N	B
5636	278	DIN 6527L	Slot drills GH 100 U (3-fluted), set	Solid carbide	NH	
5645	267	DIN 6527L	Ratio end mill sets RF 100 U	Solid carbide	N	
6700	81	DIN 6527L	Ratio end mills RF 100 VA	Solid carbide	N	A
6701	81	DIN 6527L	Ratio end mills RF 100 VA	Solid carbide	N	B
6702	117	Company std.	Ratio end mills Alu RF 100 A	Solid carbide	W	
6703	119	Company std.	Ratio end mills Alu RF 100 A	Solid carbide	W	
6704	64	DIN 6527L	Hard roughing end mills GS 100 H (fine teeth)	Solid carbide	HR	A
6705	64	DIN 6527L	Hard roughing end mills GS 100 H (fine teeth)	Solid carbide	HR	B
6706	33	DIN 6527K	Standard Ratio end mills RF 100 U	Solid carbide	N	A
6707	83	DIN 6527L	Ratio end mills RF 100 VA	Solid carbide	N	A
6708	83	DIN 6527L	Ratio end mills RF 100 VA	Solid carbide	N	B
6709	52, 108, 133	Company std.	Ratio end mills Superfinish RF 100 SF	Solid carbide	NH	
6710	52, 108, 133	Company std.	Ratio end mills Superfinish RF 100 SF	Solid carbide	NH	
6711	226	Company std.	Chamfering milling cutters	Solid carbide	N	
6712	226	Company std.	Chamfering milling cutters	Solid carbide	N	
6713	227	Company std.	Chamfering milling cutters	Solid carbide	N	
6714	229	Company std.	Chamfering milling cutters	Solid carbide	N	
6715	229	Company std.	Chamfering milling cutters	Solid carbide	N	
6716	22, 87	Company std.	Pilot end mills RF 100 P	Solid carbide	NH	A
6717	153	Company std.	Kevlar end mills CR 100	Solid carbide	CR 100	
6718	155	Company std.	Kevlar end mills with internal cooling CR 100 Air	Solid carbide	CR 100	
6719	154	Company std.	Kevlar end mills CR 100	Solid carbide	CR 100	
6720	152	Company std.	Kevlar end mills CR 100	Solid carbide	CR 100	
6721	143	Company std.	Slot drills XL (3-fluted)	Solid carbide	N	
6722	144	DIN 6527L	Slot drills with corner radius (2-fluted)	Solid carbide	N	A
6723	145	DIN 6527L	End mills with corner radius (4-fluted)	Solid carbide	N	A
6724	146	DIN 6527L	Ball nose slot drills (2-fluted)	Solid carbide	N	A
6725	147	Company std.	Ball nose end mills (4-fluted)	Solid carbide	N	
6726	37, 102	DIN 6527L	Standard Ratio end mills RF 100 U	Solid carbide	N	A
6727	107	Company std.	Ratio end mills Superfinish RF 100 SF	Solid carbide	NH	
6728	77	Company std.	Standard Ratio end mills RF 100 U (3-fluted)	Solid carbide	N	
6729	118	Company std.	Ratio end mills Alu RF 100 A	Solid carbide	W	A
6730	120	Company std.	Ratio end mills Alu RF 100 A	Solid carbide	W	A
6731	120	Company std.	Ratio end mills Alu RF 100 A	Solid carbide	W	A
6732	121	Company std.	Ratio end mills Alu RF 100 A	Solid carbide	W	A
6733	121	Company std.	Ratio end mills Alu RF 100 A	Solid carbide	W	A
6734	122	Company std.	Ratio end mills Alu RF 100 A	Solid carbide	W	A
6735	122	Company std.	Ratio end mills Alu RF 100 A	Solid carbide	W	A
6736	26, 91	DIN 6527L	Ratio end mills RF 100 DIVER	Solid carbide	N	B
6737	26, 91	DIN 6527L	Ratio end mills RF 100 DIVER	Solid carbide	N	A
6754	260	DIN 6527L	Ratio end mill sets RF 100 Diver	Solid carbide	N	
6755	259	DIN 6527L	Ratio end mill sets RF 100 Diver	Solid carbide	N	
6756	292	DIN 844K	Roughing end mills GS 80 with fine teeth	HSS-E-PM	NRf	B
6760	31, 97	Company std.	Ratio end mills RF 100 Speed	Solid carbide	NH	B
6761	32, 98	Company std.	Ratio end mills RF 100 Speed	Solid carbide	NH	B
6762	124	DIN 6527L	Ratio end mills Alu RF 100 A 90°	Solid carbide	W	A



Article no.	Page	Standard	Description	Tool material	Type	Form
6763	55, 111, 136	Company std.	Ratio end mills Superfinish RF 100 SF 90°	Solid carbide	NH	
6764	29, 95	DIN 6527L	Ratio end mills RF 100 F 90°	Solid carbide	NH	A
6765	31, 97	Company std.	Ratio end mills RF 100 Speed	Solid carbide	NH	A
6766	32, 98	Company std.	Ratio end mills RF 100 Speed	Solid carbide	NH	A
6767	41	Company std.	Standard Ratio end mills RF 100 U	Solid carbide	NH	A
6768	41	Company std.	Standard Ratio end mills RF 100 U	Solid carbide	NH	B
6769	149	Company std.	Kevlar end mills FR 100	Solid carbide	FR 100	
6770	150	Company std.	Kevlar end mills FR 100	Solid carbide	FR 100	
6771	186	Company std.	HSC end mills High Feed HF 300	Solid carbide	H	
6772	187	Company std.	HSC end mills High Feed HF 300	Solid carbide	H	
6777	263	Company std.	Ratio end mill sets RF 100 Speed	Solid carbide	NH	A
6778	261	Company std.	Ratio end mill sets RF 100 Speed	Solid carbide	NH	A
6780	262	Company std.	Ratio end mill sets RF 100 Speed	Solid carbide	NH	B
6781	264	Company std.	Ratio end mill sets RF 100 Speed	Solid carbide	NH	B
6784	228	Company std.	Chamfering milling cutters	Solid carbide	H	
6785	228	Company std.	Chamfering milling cutters	Solid carbide	H	
6786	230	Company std.	Chamfering milling cutters	Solid carbide	N	
6787	230	Company std.	Chamfering milling cutters	Solid carbide	N	
6788	232	Company std.	Quadrant milling cutters	Solid carbide	N	
6793	128	Company std.	End mills (single-fluted)	Solid carbide	W	
6797	24, 88	Company std.	Ratio end mills RF 100 DIVER (3-fluted)	Solid carbide	NH	
6798	24, 88	Company std.	Ratio end mills RF 100 DIVER (3-fluted)	Solid carbide	NH	
6799	89	Company std.	Ratio end mills RF 100 DIVER (3-fluted)	Solid carbide	NH	
6800	89	Company std.	Ratio end mills RF 100 DIVER (3-fluted)	Solid carbide	NH	
6801	92	DIN 6527L	Ratio end mills RF 100 DIVER	Solid carbide	N	
6802	92	DIN 6527L	Ratio end mills RF 100 DIVER	Solid carbide	N	
6803	25, 90	DIN 6527K	Ratio end mills RF 100 DIVER	Solid carbide	N	
6804	25, 90	DIN 6527K	Ratio end mills RF 100 DIVER	Solid carbide	N	
6868	125	Company std.	Ratio end mills Alu RF 100 A	Solid carbide	WF	
6869	125	Company std.	Ratio end mills Alu RF 100 A	Solid carbide	WF	
6870	126	Company std.	Ratio end mills Alu RF 100 A	Solid carbide	WF	
6871	126	Company std.	Ratio end mills Alu RF 100 A	Solid carbide	WF	
6877	84	DIN 6527L	Ratio end mills RF 100 VA	Solid carbide	NF	
6878	84	DIN 6527L	Ratio end mills RF 100 VA	Solid carbide	NF	B
6879	85	Company std.	Ratio end mills RF 100 VA	Solid carbide	NF	
6880	85	Company std.	Ratio end mills RF 100 VA	Solid carbide	NF	
6881	44	DIN 6527L	Standard Ratio end mills RF 100 U	Solid carbide	HF	
6882	44	DIN 6527L	Standard Ratio end mills RF 100 U	Solid carbide	HF	B
6883	45	Company std.	Standard Ratio end mills RF 100 U	Solid carbide	HF	
6884	45	Company std.	Standard Ratio end mills RF 100 U	Solid carbide	HF	
6885	46	Company std.	Standard Ratio end mills RF 100 U	Solid carbide	HF	
6886	46	Company std.	Standard Ratio end mills RF 100 U	Solid carbide	HF	
6887	47, 103	DIN 6527L	High-performance roughing end mills RS 100 U	Solid carbide	NF	
6888	47, 103	DIN 6527L	High-performance roughing end mills RS 100 U	Solid carbide	NF	B
6889	48	DIN 6527L	High-performance roughing end mills RS 100 F	Solid carbide	NF	
6890	48	DIN 6527L	High-performance roughing end mills RS 100 F	Solid carbide	NF	B

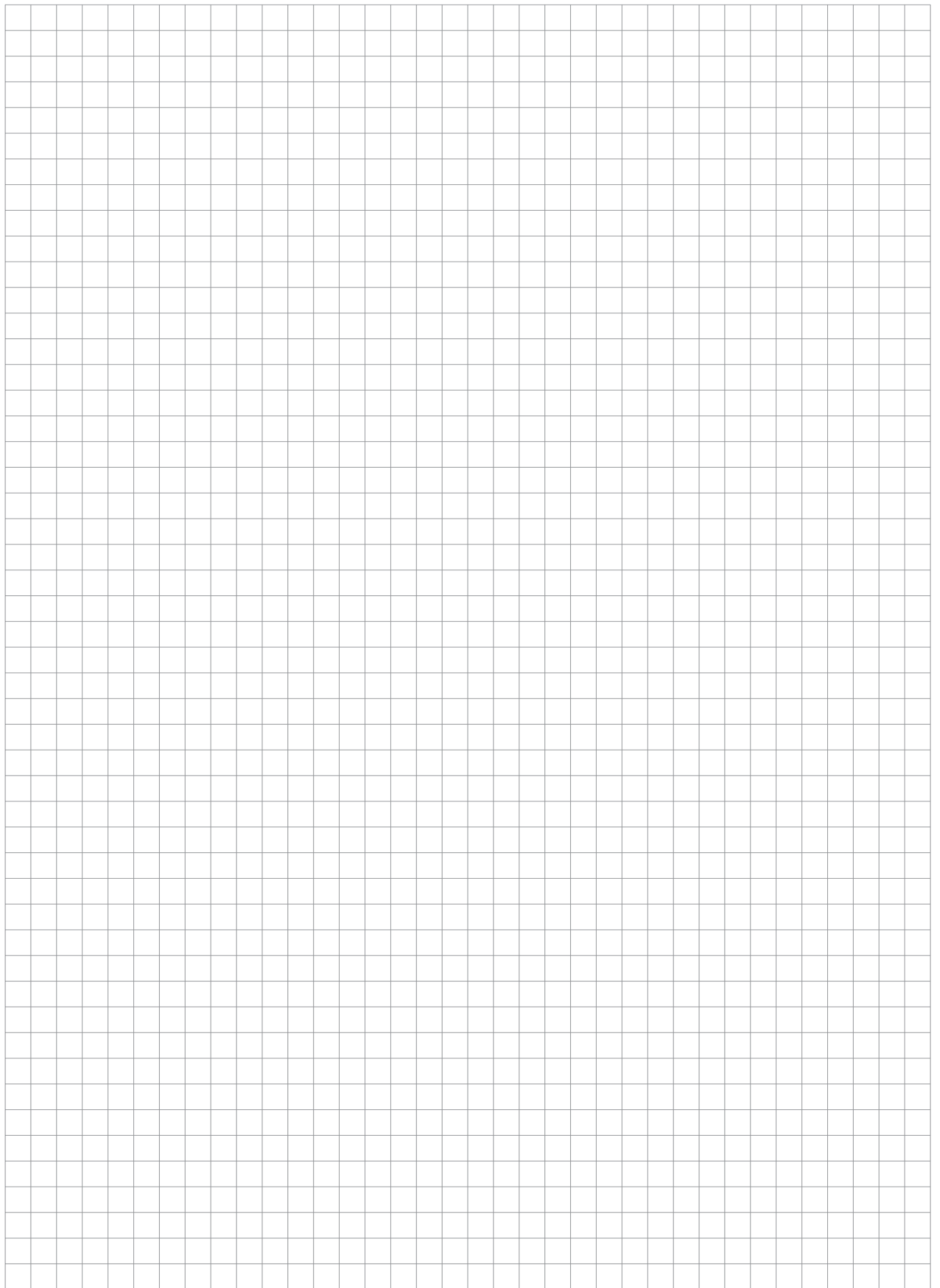

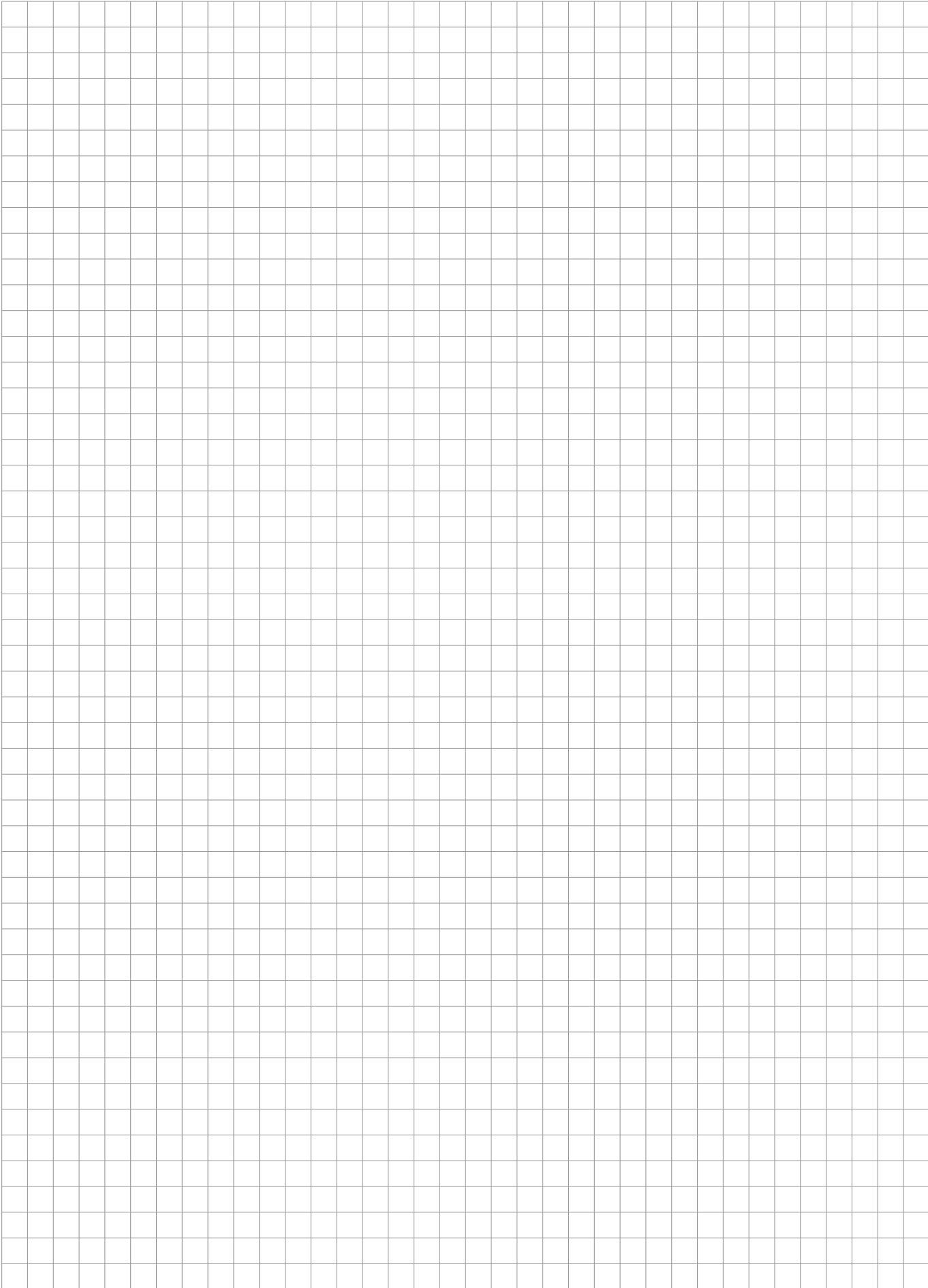

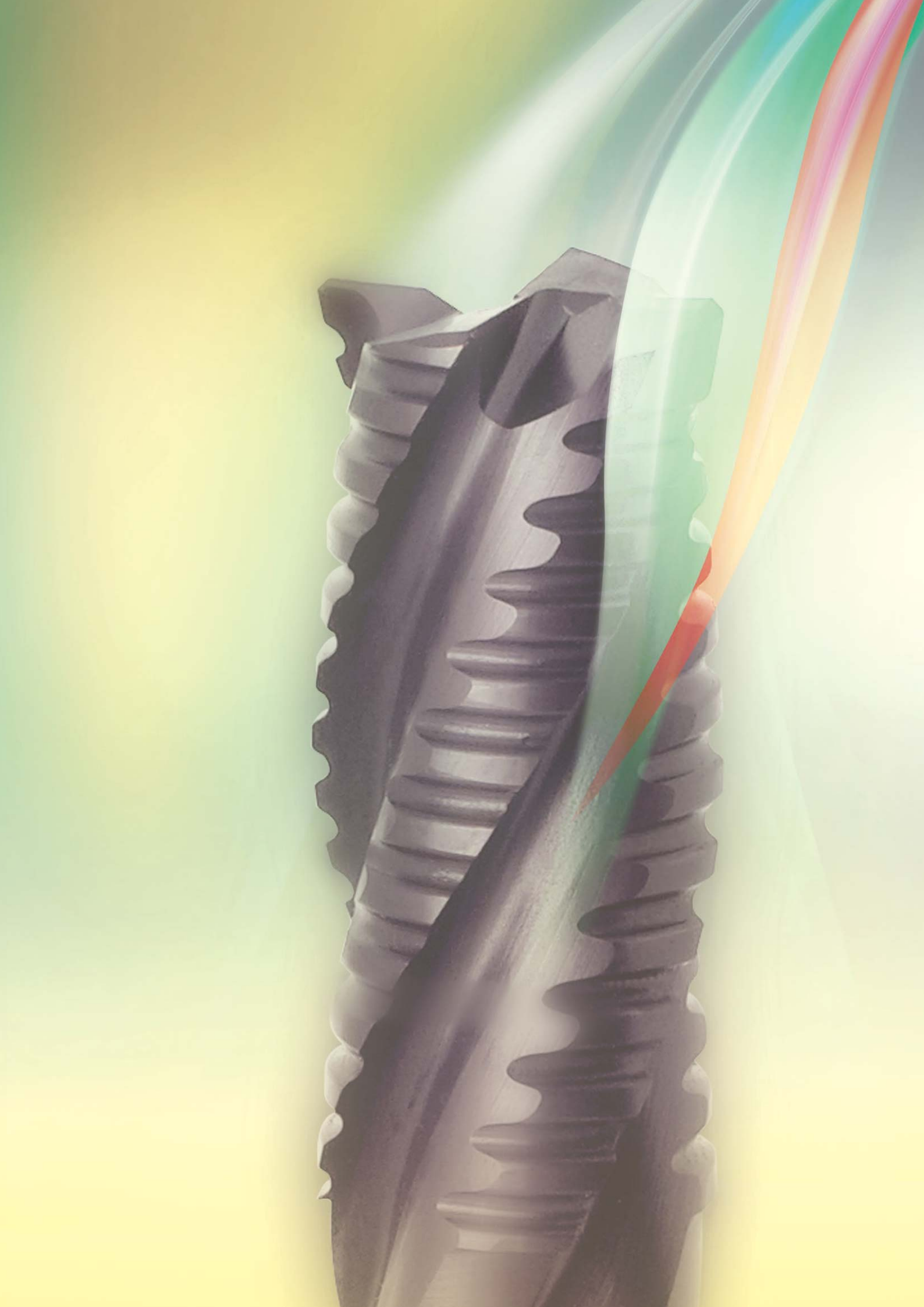

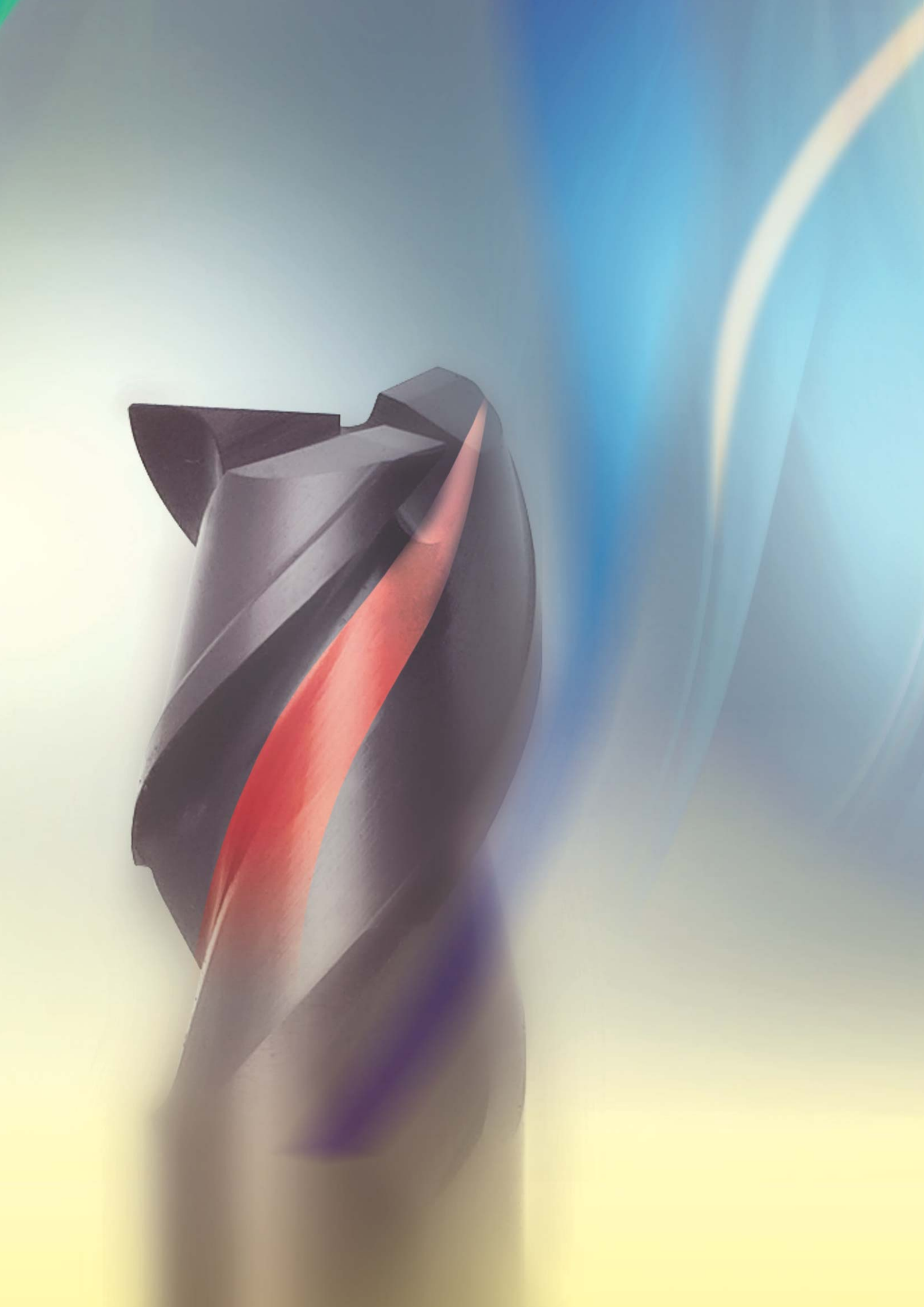

POWER MILLING



RAMPING

DRILLING

SLOTING

ROUGHING

FINISHING

GUHRING KG | Telephone: + 49 74 31 17-0 | Fax: + 49 74 31 17-21279

Herderstraße 50-54 | 72458 Albstadt | Germany | info@guehring.de | www.guehring.de